

F1152 Low IF Frequency and Lower DC Power Consumption

- May 15, 2014
- Task AT0083

Michael J. Virostko
Principal Product Application Engineer



The Analog and Digital Company™



Agenda

- Purpose
- Circuit Modifications
- Characterization
- Conclusion



Purpose

- Customer's application requires a lower DC power consumption of the F1152 Dual Downconverting Mixer.
- Customer also requires that the output IF response work from 25 – 100 MHz.
- Testing was performed in 2013 and an evaluation board was given to the customer.
- After investigation, the IF circuitry on that particular evaluation board was shown to be manufactured wrong.
- This testing is being done to confirm the original measurements.
- Along with this the customer added an RF port matching circuit and a modification to the IF output circuit which will be tested.



Low Frequency IF Circuit Modifications

- IDT's evaluation board (F1150 EV Kit Rev 5) has IF Circuitry for a frequency range of 50 to 300 MHz.

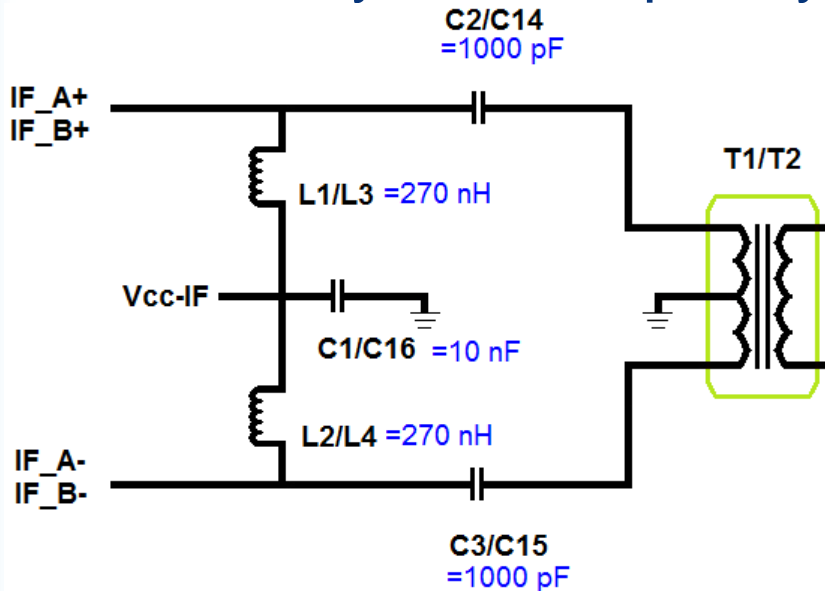

Standard Evaluation Board IF Circuitry

Modified IF Circuitry for 10 MHz Operation

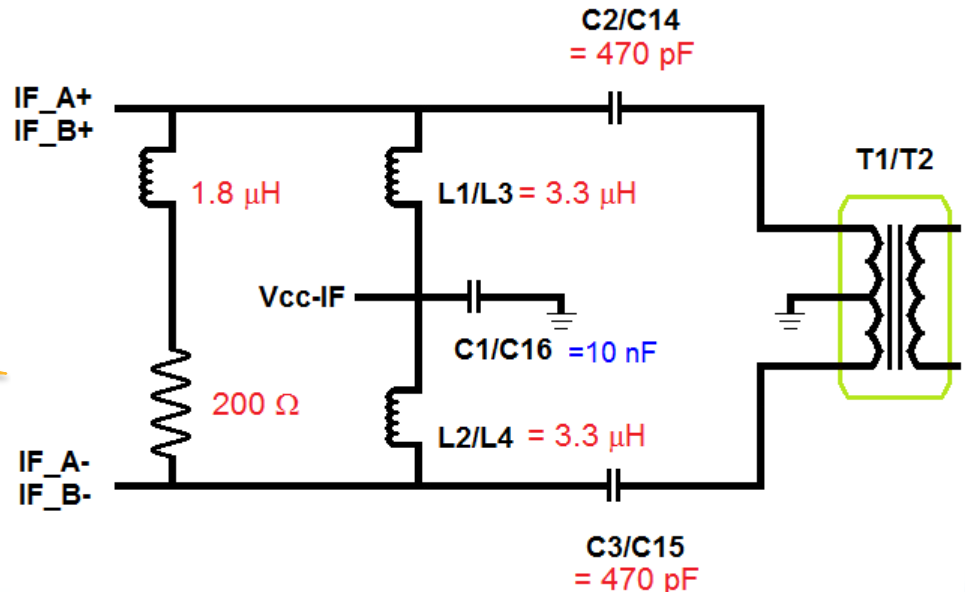

Characterization – Measurement Parameters

- Data is collected at the end of the evaluation board
 - No loss correction is done
- Low Current mode was used for all measurements. The resistors used are:
 - IF_BiasA = IF_BiasB = 62 ohms
 - LO1_Adj_Bias = 370 ohms
 - LO2_Adj_Bias = 4100 ohms
 - Different from the standard low current mode
- RF frequency was 1.700 and 1.900 GHz
- LO swept for both high and low side injection
- IF swept



Characterization – Measurement Parameters

- The Voltage applied to the IF circuit (V_{cc-IF}) was changed from 5.0 to 3.3 V.
- V_{cc-IF} must be turned on before V_{cc} .
- The current variation is in the 10's of μA . The nominal current is 53.9 mA for either applied voltage.
- DC Power is calculated for the entire device (both Channels).
- RF data was only collected on Channel B.



Low IF Circuit – Gain, High Side LO

F1152 RFto IF Dual Downconverting Mixer
Vcc-IF= +3.3 V, Vcc = +5.0 V, Low Frequency IF Circuitry
RF Fixed Frequency, High Side LO Injection (RF < LO), IF = LO - RF

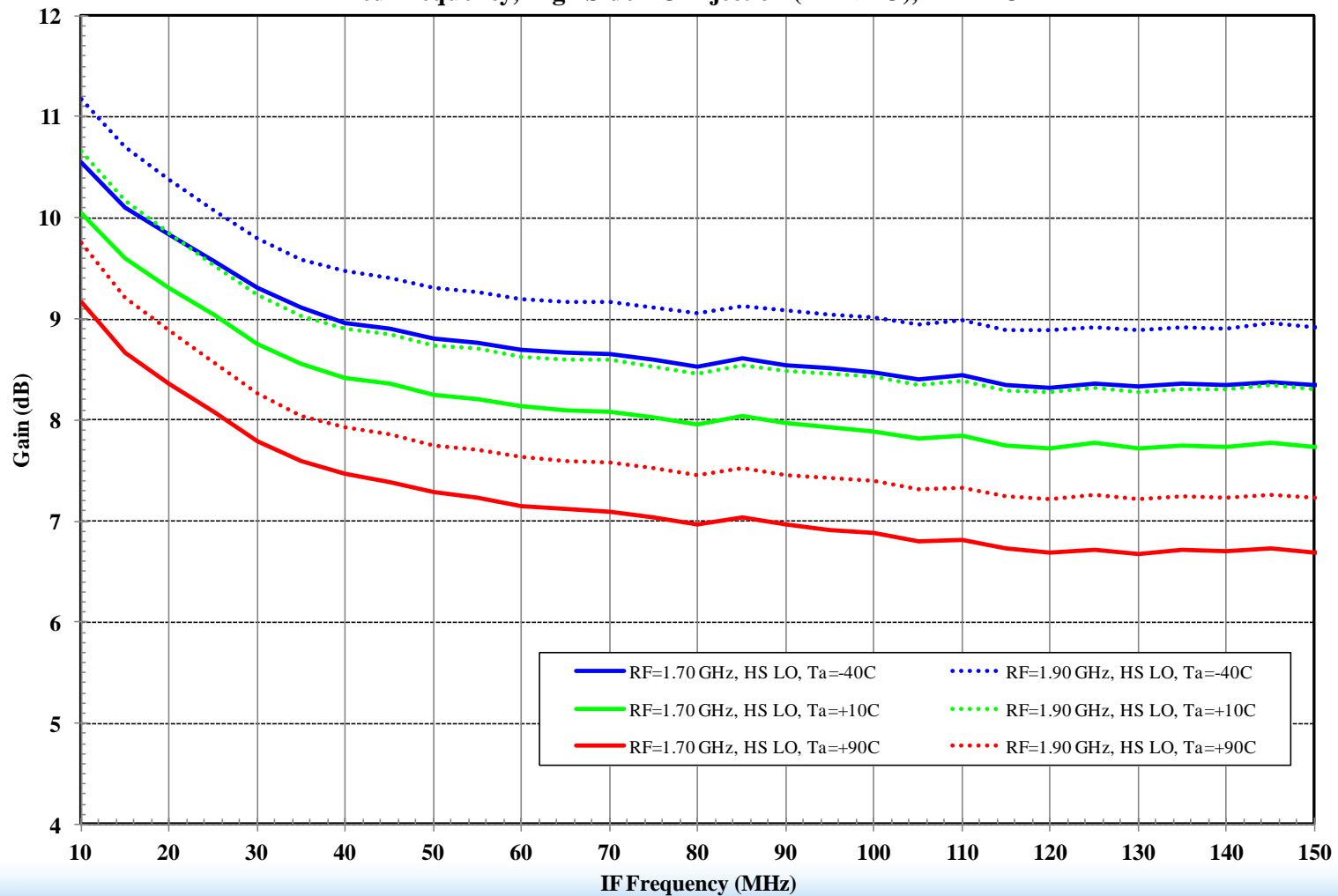

Low IF Circuit – Gain, Low Side LO

F1152 RF to IF Dual Downconverting Mixer
Vcc-IF = +3.3 V, Vcc = +5.0 V, Low Frequency IF Circuitry
RF Fixed Frequency, Low Side LO Injection (RF > LO), IF = RF - LO

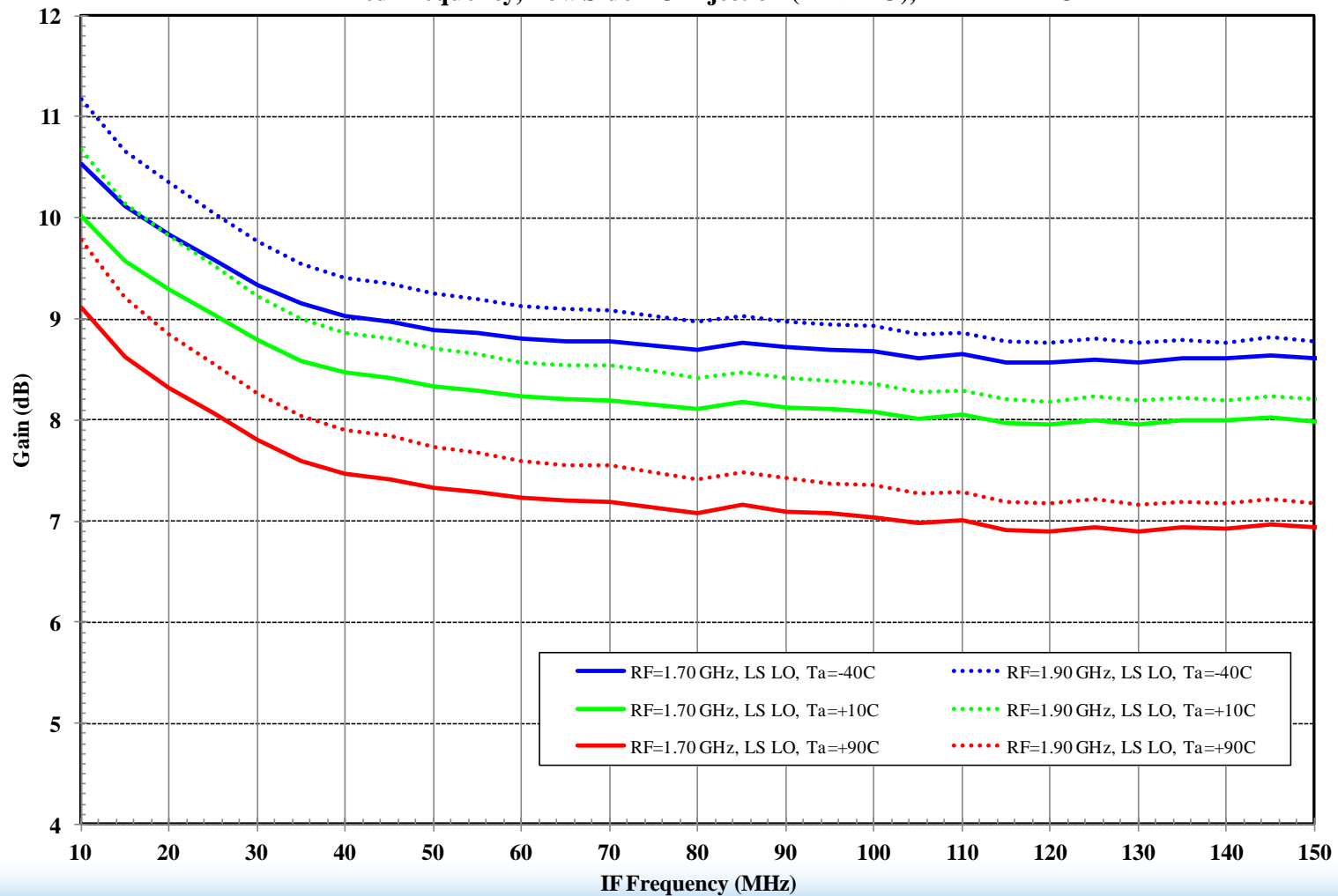

Low IF Circuit – OIP3, High Side LO

F1152 RFto IF Dual Downconverting Mixer
Vcc-IF= +3.3 V, Vcc = +5.0 V, Low Frequency IF Circuitry
RF Fixed Frequency, High Side LO Injection (RF < LO), IF = LO - RF

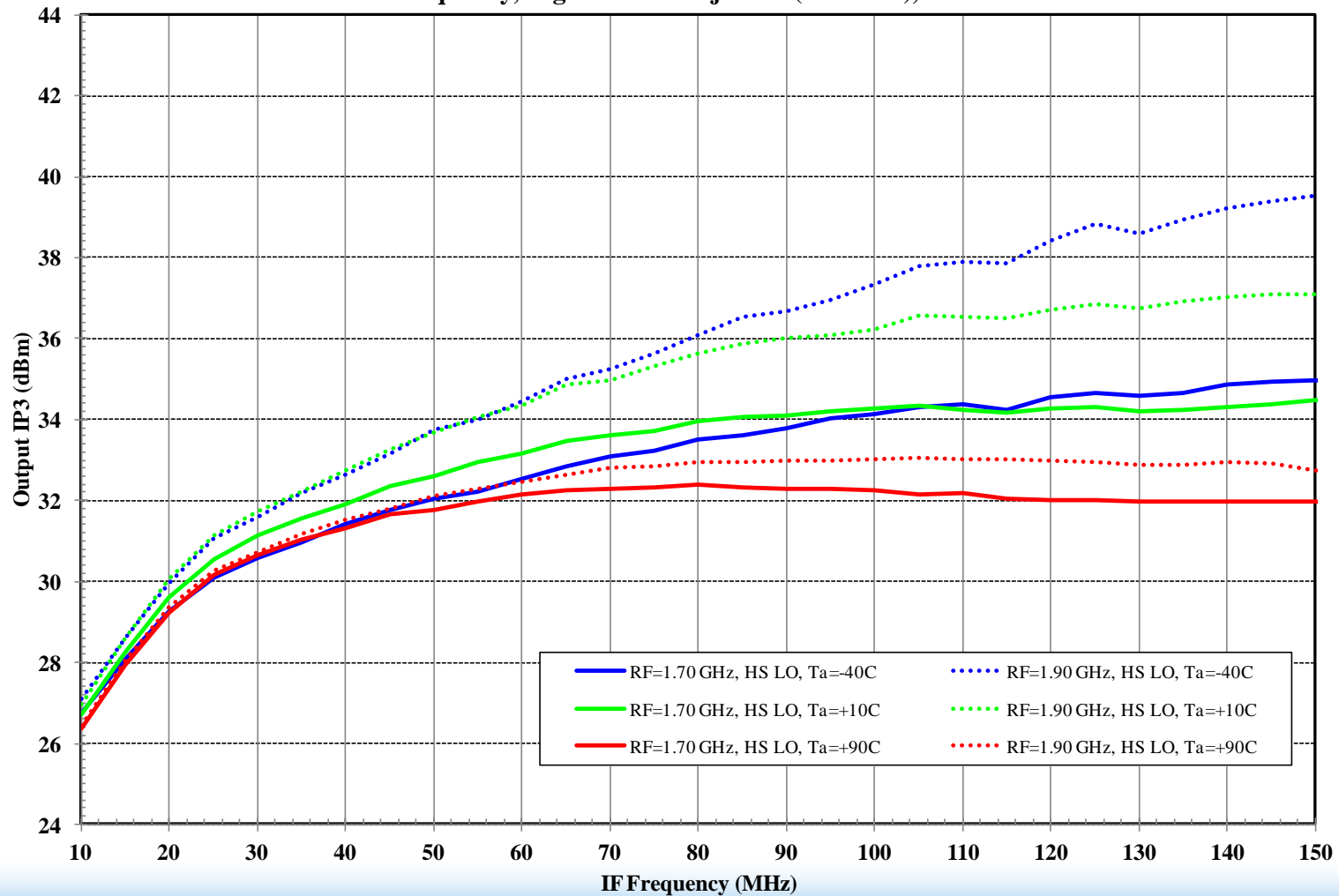

Low IF Circuit – OIP3, Low Side LO

F1152 RF to IF Dual Downconverting Mixer
Vcc-IF = +3.3 V, Vcc = +5.0 V, Low Frequency IF Circuitry
RF Fixed Frequency, Low Side LO Injection (RF > LO), IF = RF - LO

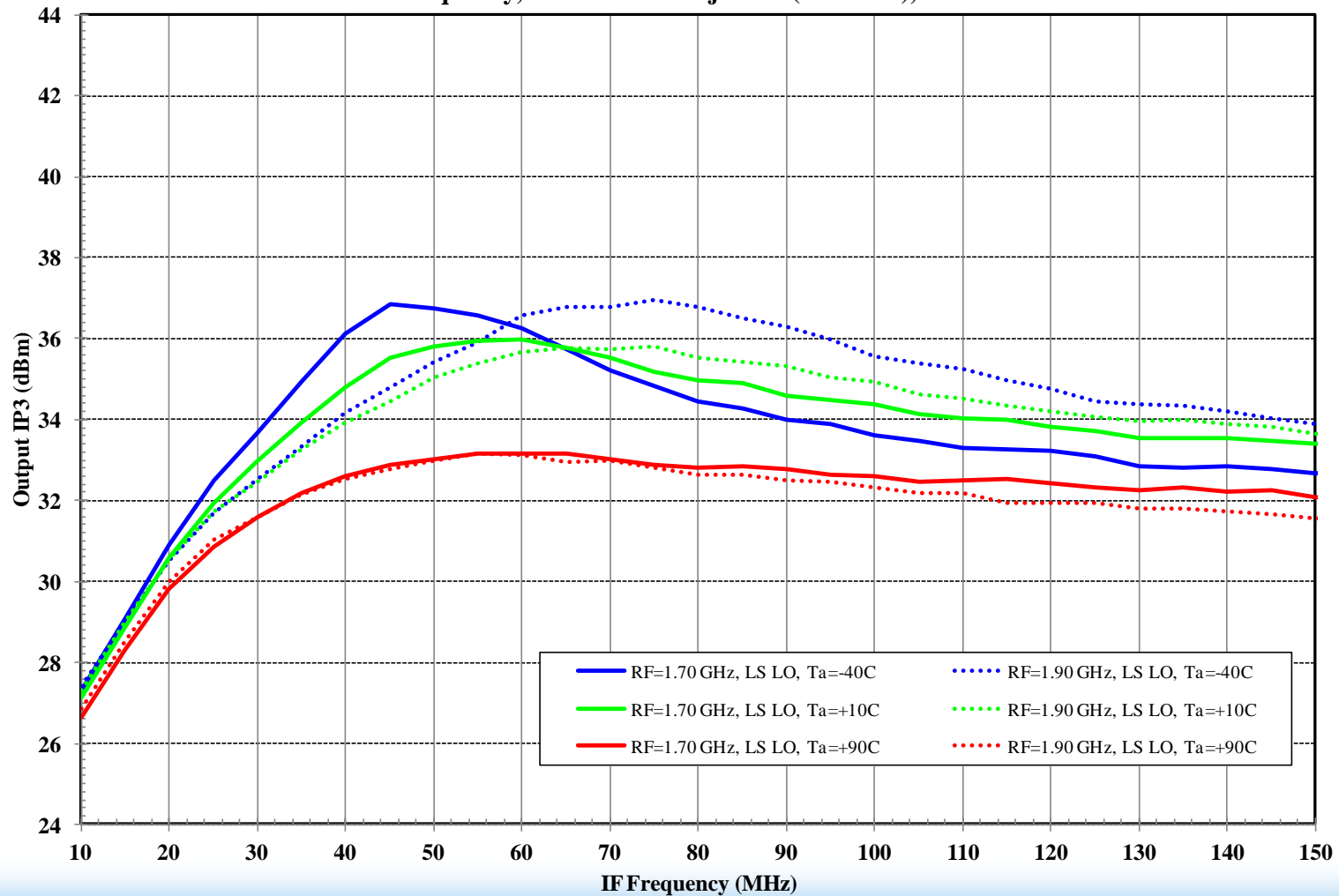

Low IF Circuit – IIP3, High Side LO

F1152 RFto IF Dual Downconverting Mixer
Vcc-IF= +3.3 V, Vcc = +5.0 V, Low Frequency IF Circuitry
RF Fixed Frequency, High Side LO Injection (RF < LO), IF = LO - RF

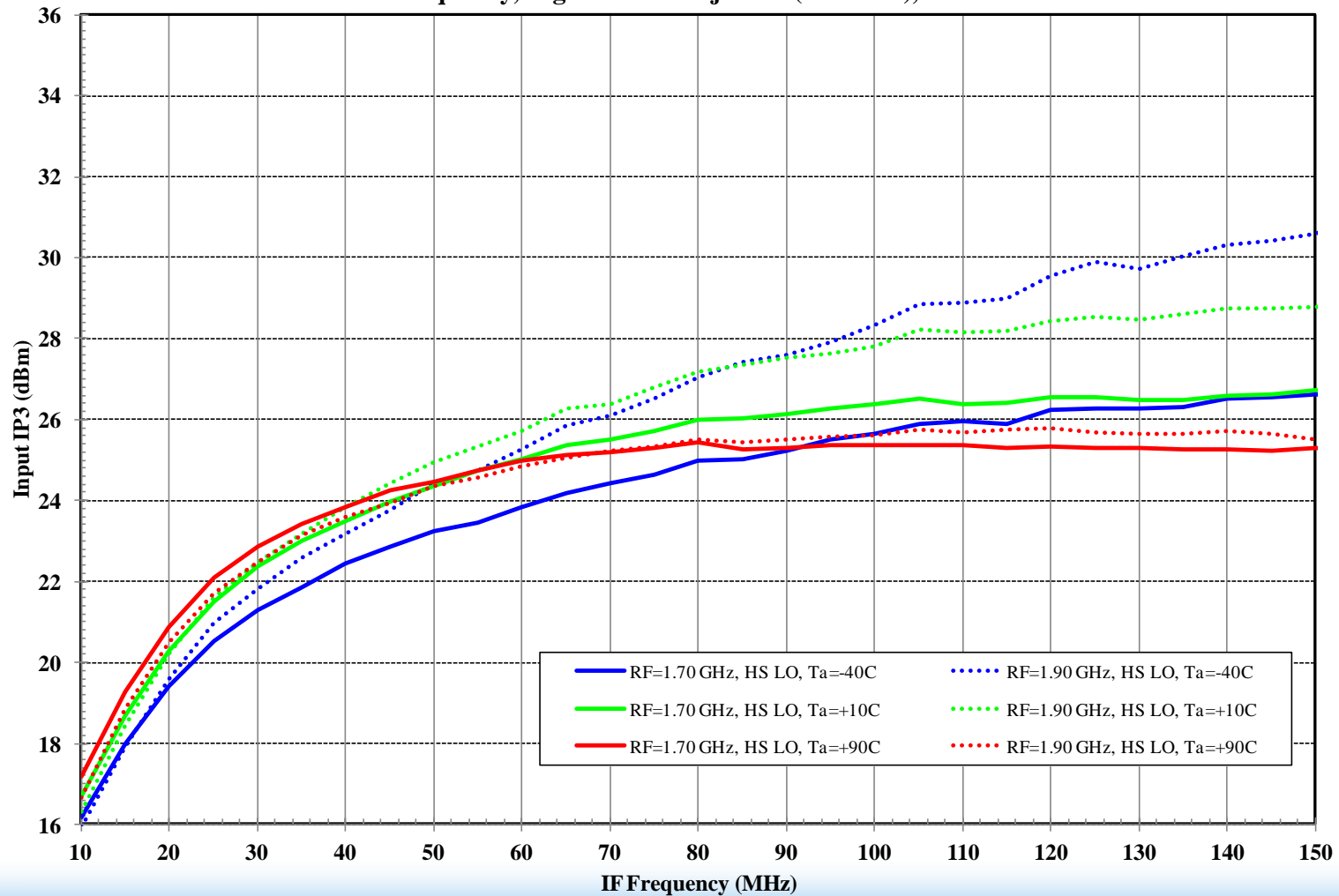

Low IF Circuit – IIP3, Low Side LO

F1152 RF to IF Dual Downconverting Mixer
Vcc-IF = +3.3 V, Vcc = +5.0 V, Low Frequency IF Circuitry
RF Fixed Frequency, Low Side LO Injection (RF > LO), IF = RF - LO

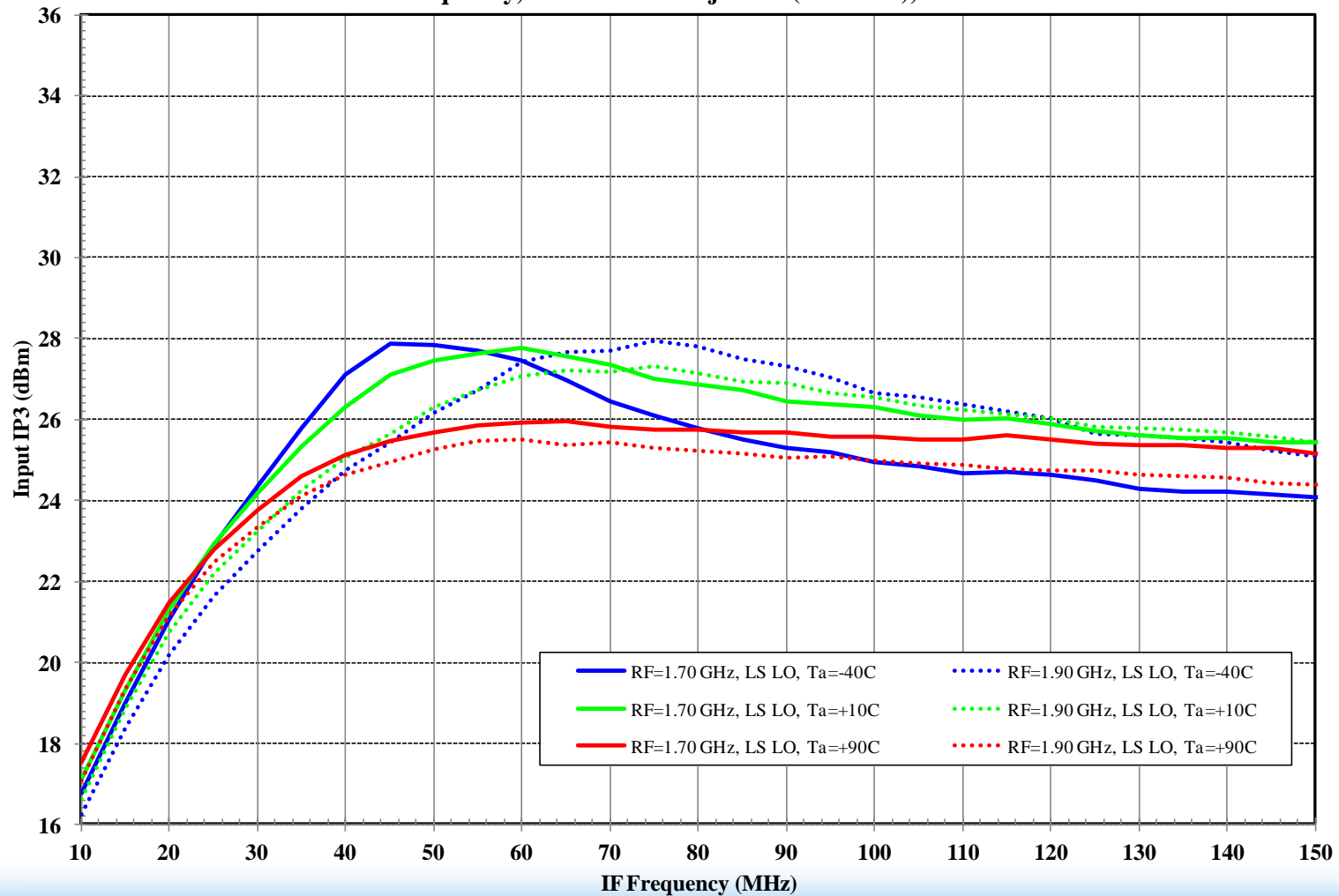

Low IF Circuit – DC Power, High Side LO

F1152 RFto IF Dual Downconverting Mixer
Vcc-IF= +3.3 V, Vcc = +5.0 V, Low Frequency IF Circuitry
RF Fixed Frequency, High Side LO Injection (RF < LO), IF = LO - RF

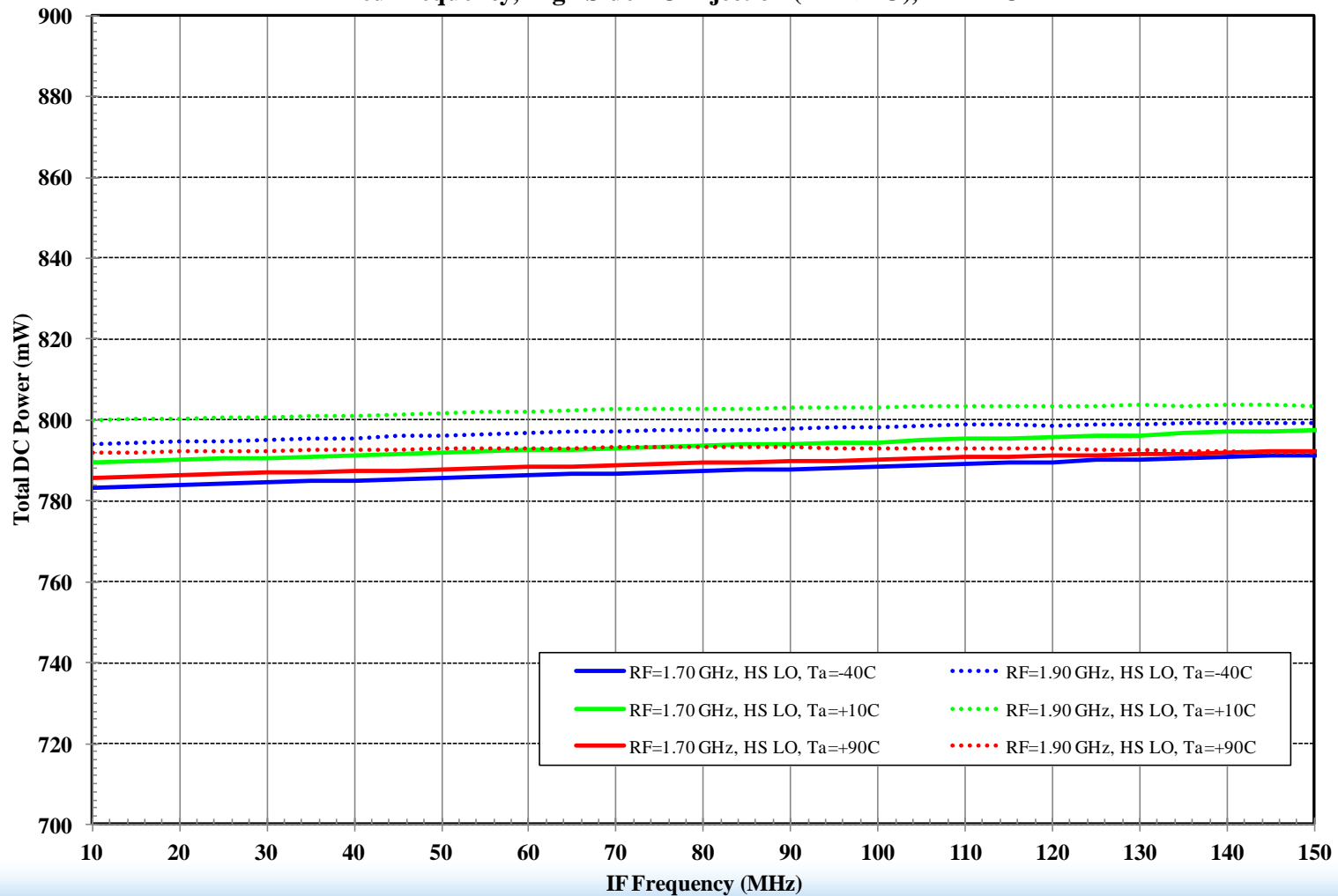

Low IF Circuit – DC Power, Low Side LO

F1152 RF to IF Dual Downconverting Mixer
Vcc-IF = +3.3 V, Vcc = +5.0 V, Low Frequency IF Circuitry
RF Fixed Frequency, Low Side LO Injection (RF > LO), IF = RF - LO

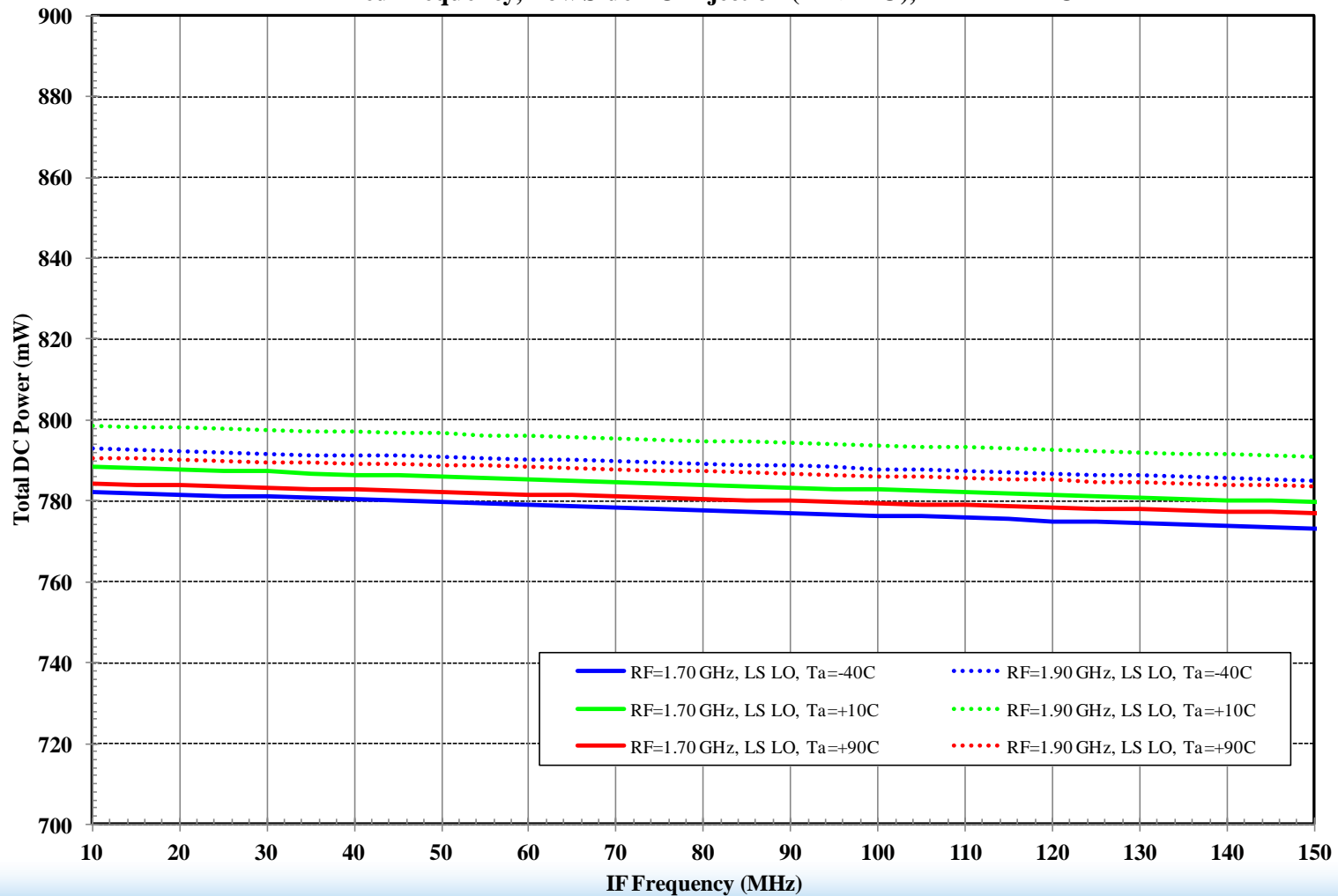

Low IF Circuit – OP1dB, High Side LO

F1152 RFto IF Dual Downconverting Mixer
Vcc-IF= +3.3 V, Vcc = +5.0 V, Low Frequency IF Circuitry
RF Fixed Frequency, High Side LO Injection (RF < LO), IF = LO - RF

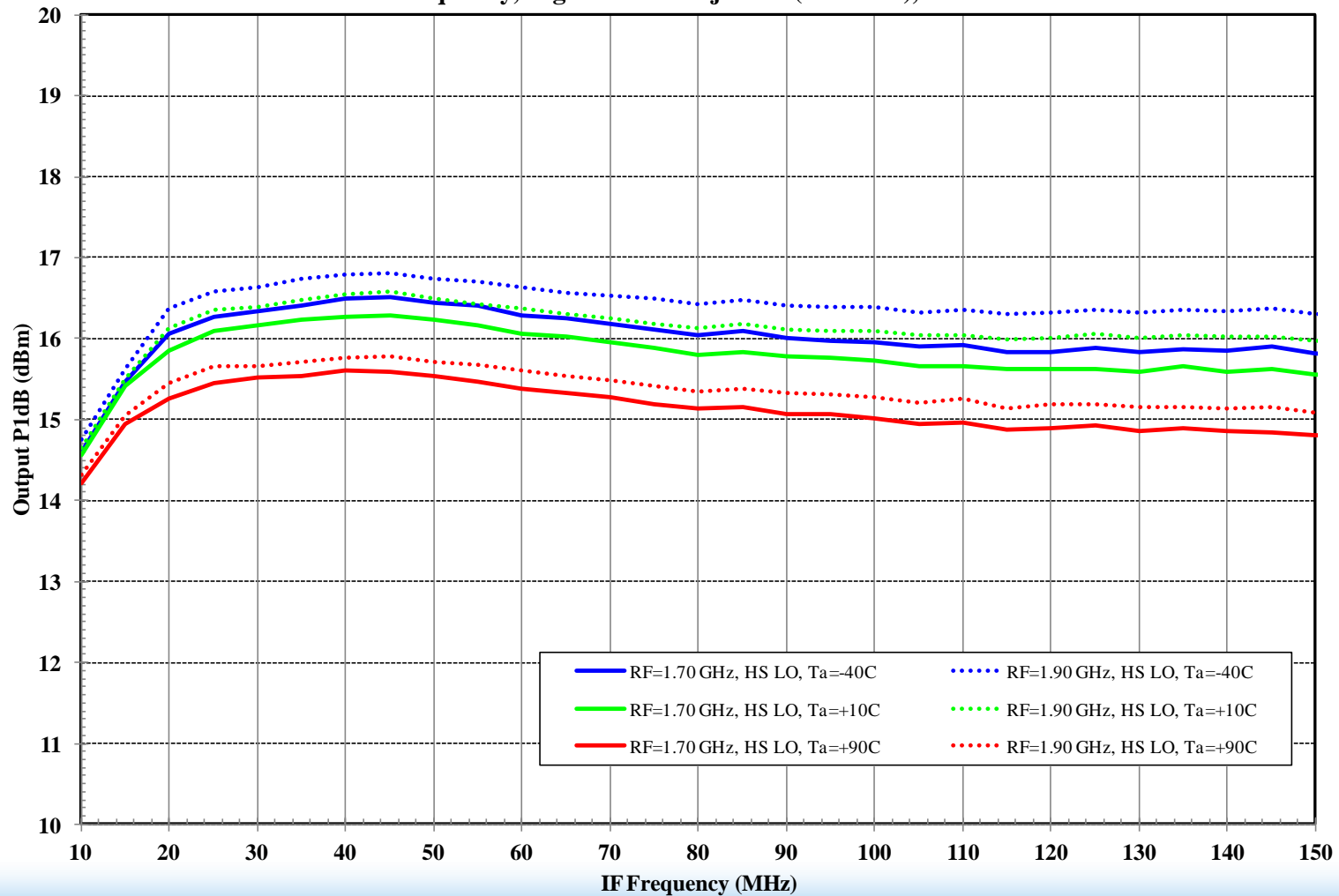

Low IF Circuit – OP1dB, Low Side LO

F1152 RF to IF Dual Downconverting Mixer
Vcc-IF = +3.3 V, Vcc = +5.0 V, Low Frequency IF Circuitry
RF Fixed Frequency, Low Side LO Injection (RF > LO), IF = RF - LO

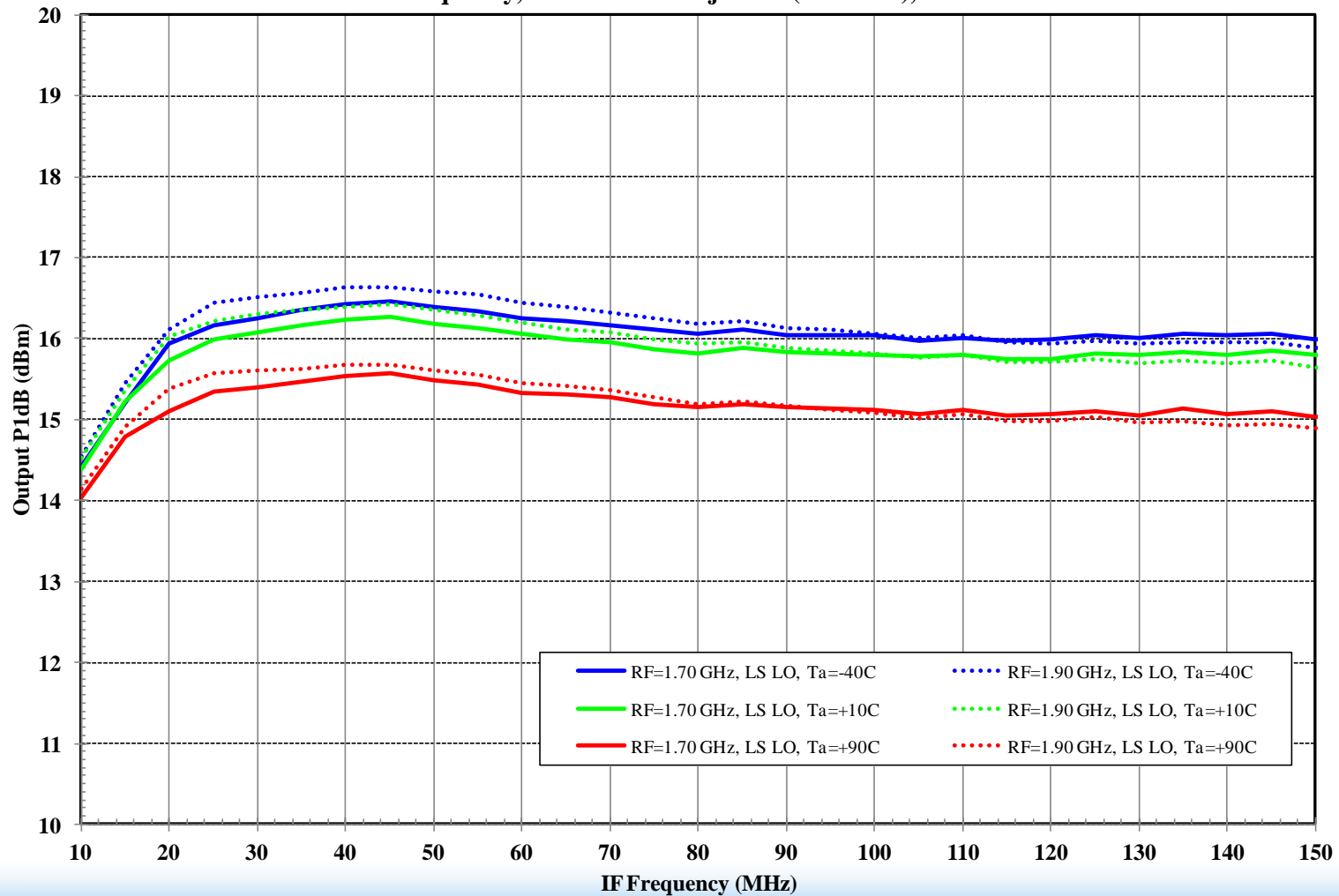

Low IF Circuit – OIP2, High Side LO

F1152 RFto IF Dual Downconverting Mixer
Vcc-IF= +3.3 V, Vcc = +5.0 V, Low Frequency IF Circuitry
RF Fixed Frequency, High Side LO Injection (RF < LO), IF = LO - RF

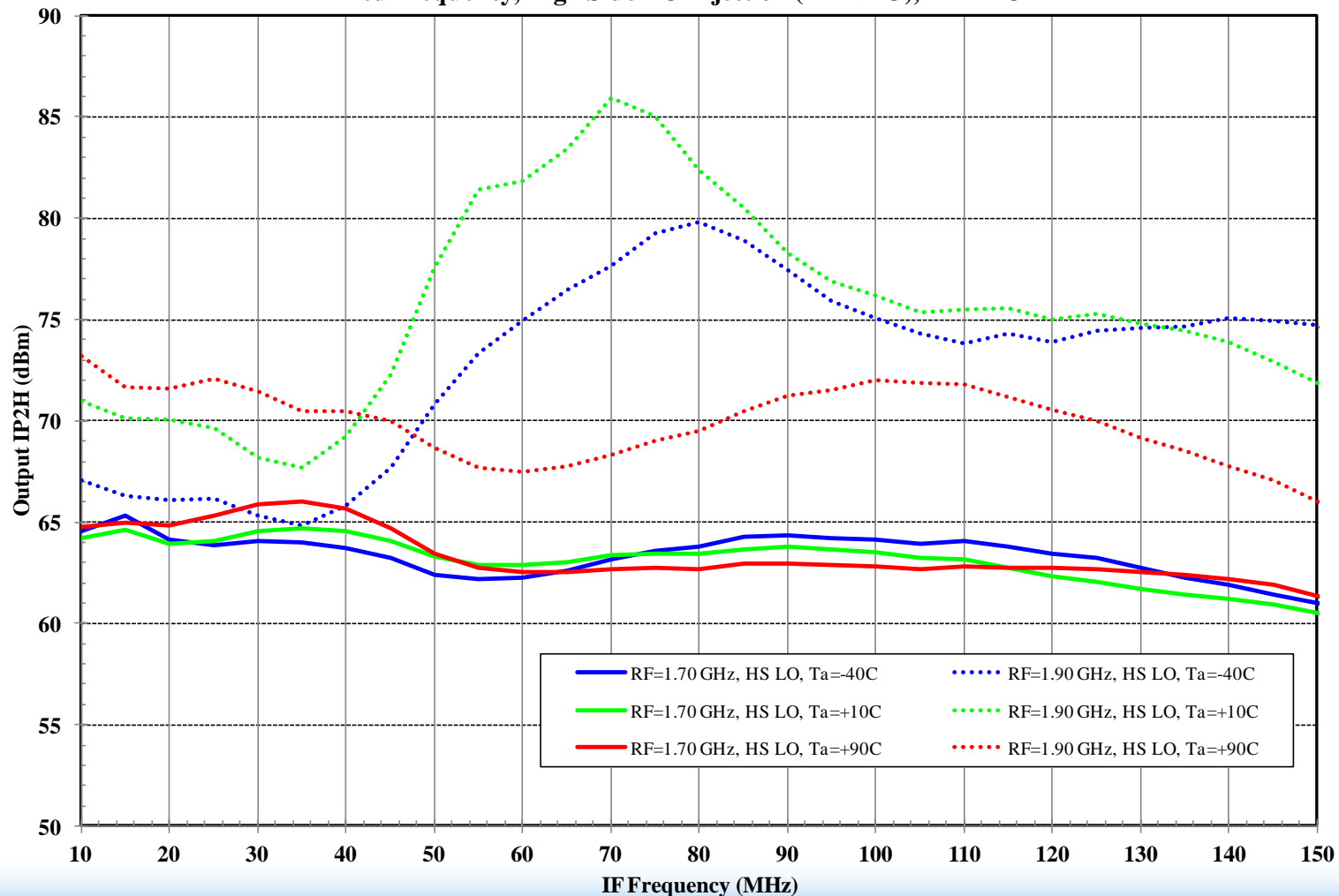

Low IF Circuit – OIP2, Low Side LO

F1152 RF to IF Dual Downconverting Mixer
Vcc-IF = +3.3 V, Vcc = +5.0 V, Low Frequency IF Circuitry
RF Fixed Frequency, Low Side LO Injection (RF > LO), IF = RF - LO

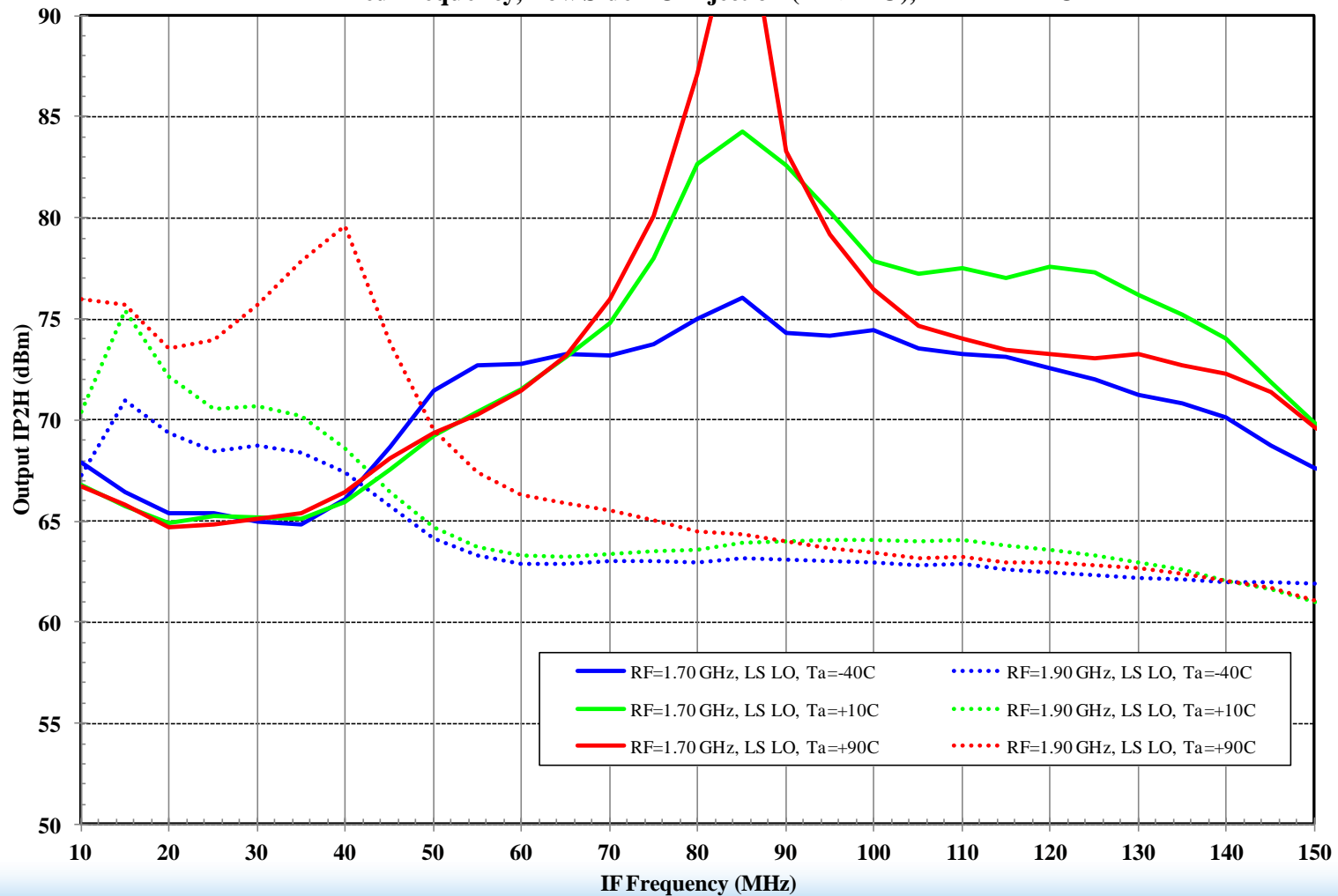

Low IF Circuit – 2x2 Rejection, High Side LO

F1152 RFto IF Dual Downconverting Mixer
Vcc-IF= +3.3 V, Vcc = +5.0 V, Low Frequency IF Circuitry
RF Fixed Frequency, High Side LO Injection (RF < LO), IF = LO - RF

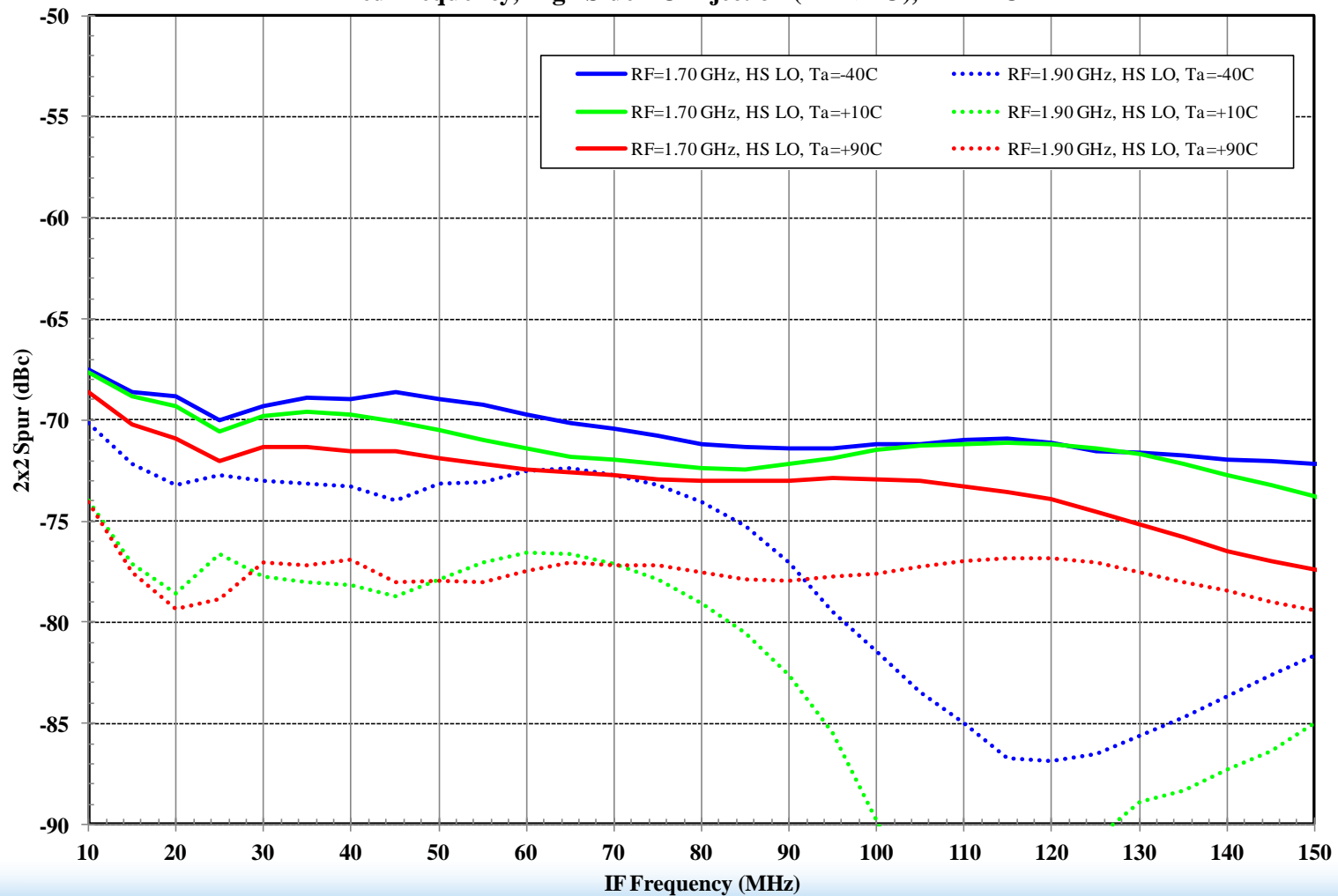

Low IF Circuit – 2x2 Rejection, Low Side LO

F1152 RF to IF Dual Downconverting Mixer
Vcc-IF = +3.3 V, Vcc = +5.0 V, Low Frequency IF Circuitry
RF Fixed Frequency, Low Side LO Injection (RF > LO), IF = RF - LO

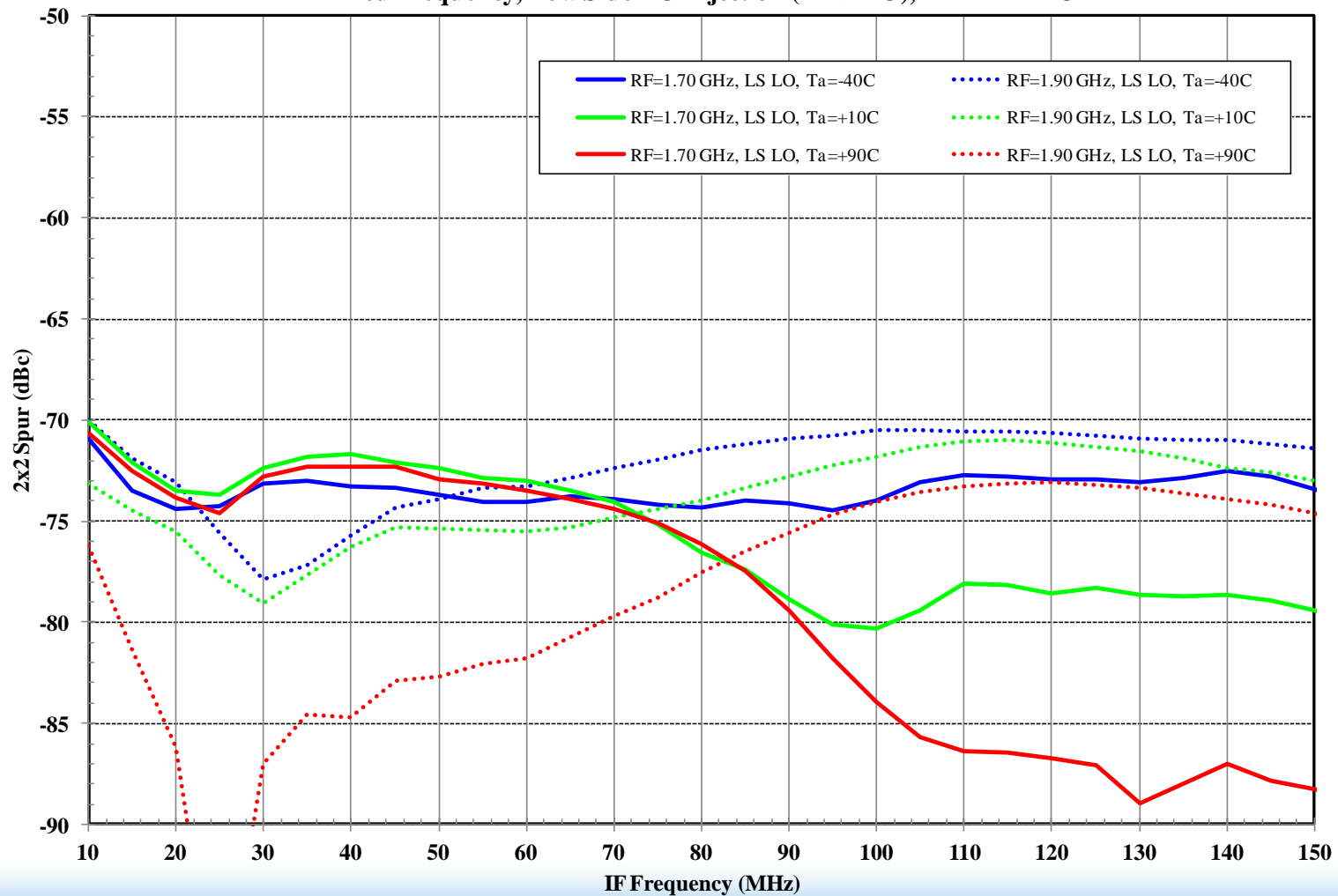

Low IF Circuit – 3x3 Rejection, High Side LO

F1152 RFto IF Dual Downconverting Mixer
Vcc-IF= +3.3 V, Vcc = +5.0 V, Low Frequency IF Circuitry
RF Fixed Frequency, High Side LO Injection (RF < LO), IF = LO - RF

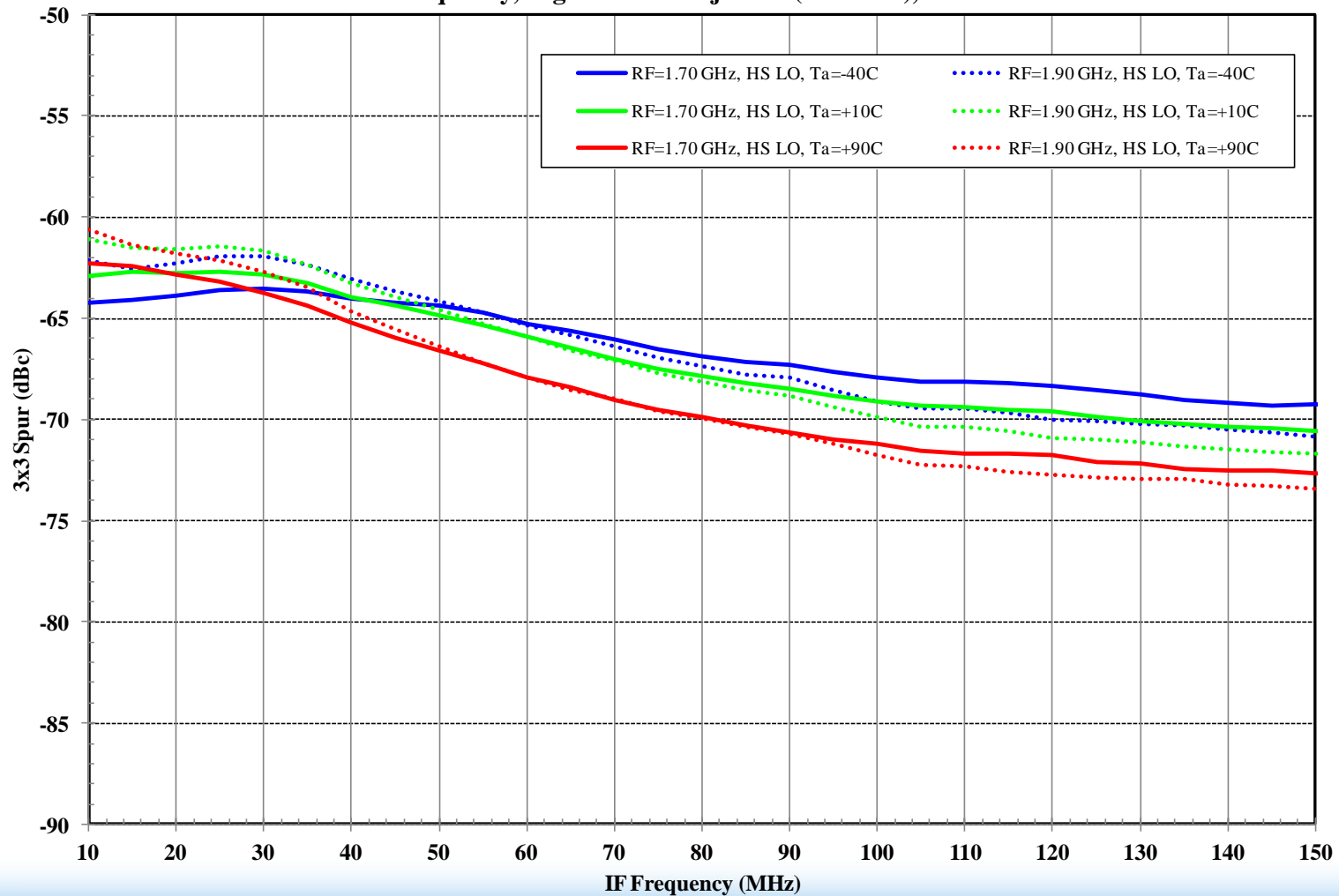

Low IF Circuit – 3x3 Rejection, Low Side LO

F1152 RF to IF Dual Downconverting Mixer
Vcc-IF = +3.3 V, Vcc = +5.0 V, Low Frequency IF Circuitry
RF Fixed Frequency, Low Side LO Injection (RF > LO), IF = RF - LO

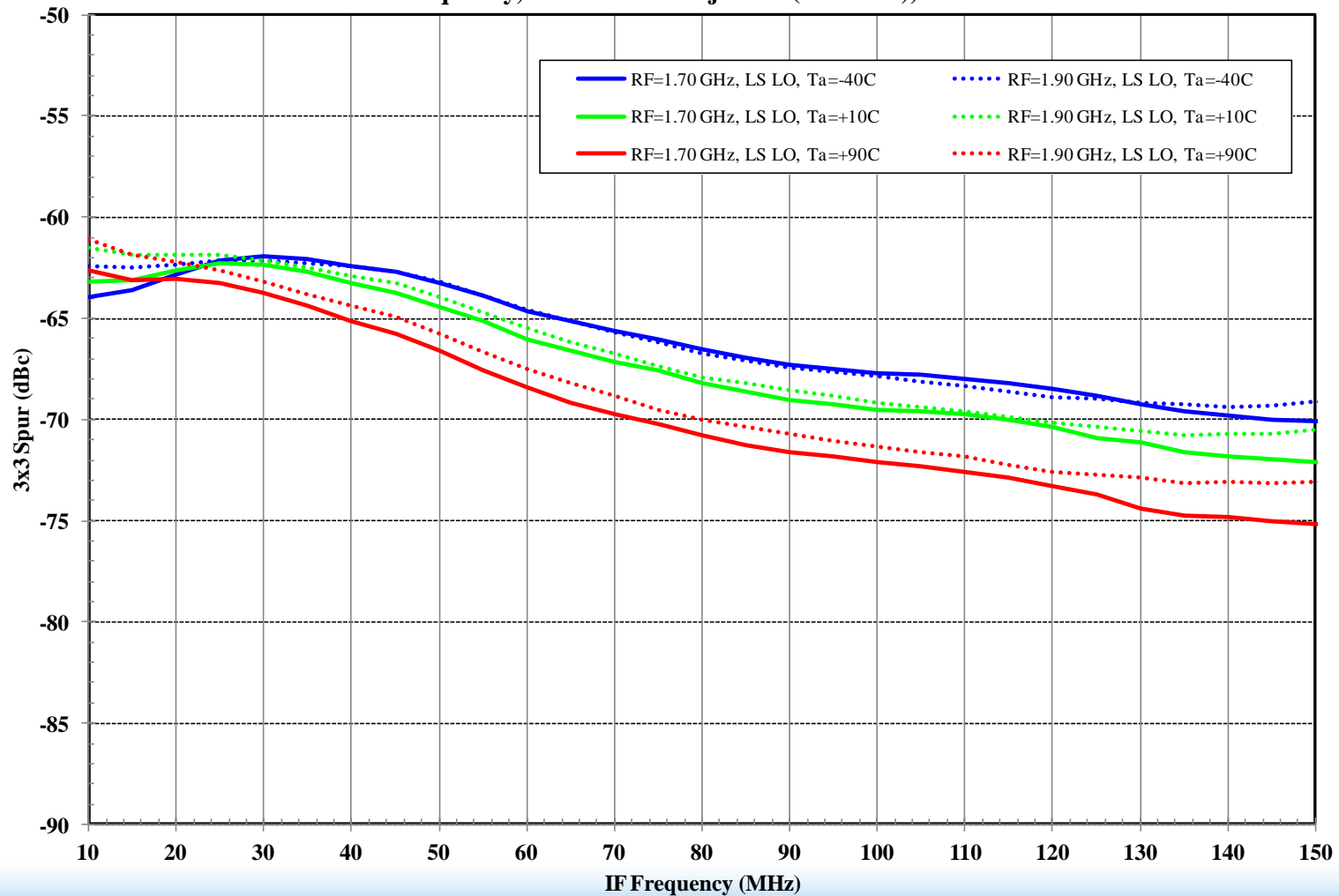

RF Circuit Modifications

- IDT's evaluation board was modified for the customer's RF circuitry.

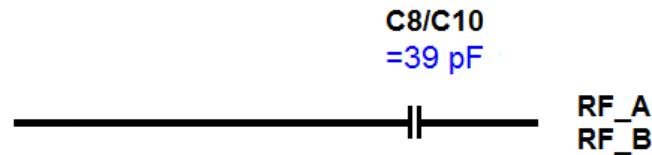

Standard Evaluation Board RF Circuitry

Modified RF Circuitry for Customer's use

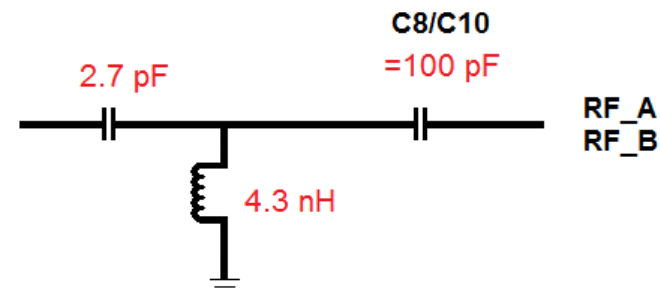

RF Match – Measurement Parameters

- The measurements were done exactly the same as the Low IF circuitry testing.



RF Match – Gain, High Side LO

F1152 RF to IF Dual Downconverting Mixer
 $V_{cc-IF} = +3.3\text{ V}$, $V_{cc} = +5.0\text{ V}$, Low Frequency IF Circuitry, **RF Port Match**
RF Fixed Frequency, High Side LO Injection ($RF < LO$), $IF = LO - RF$

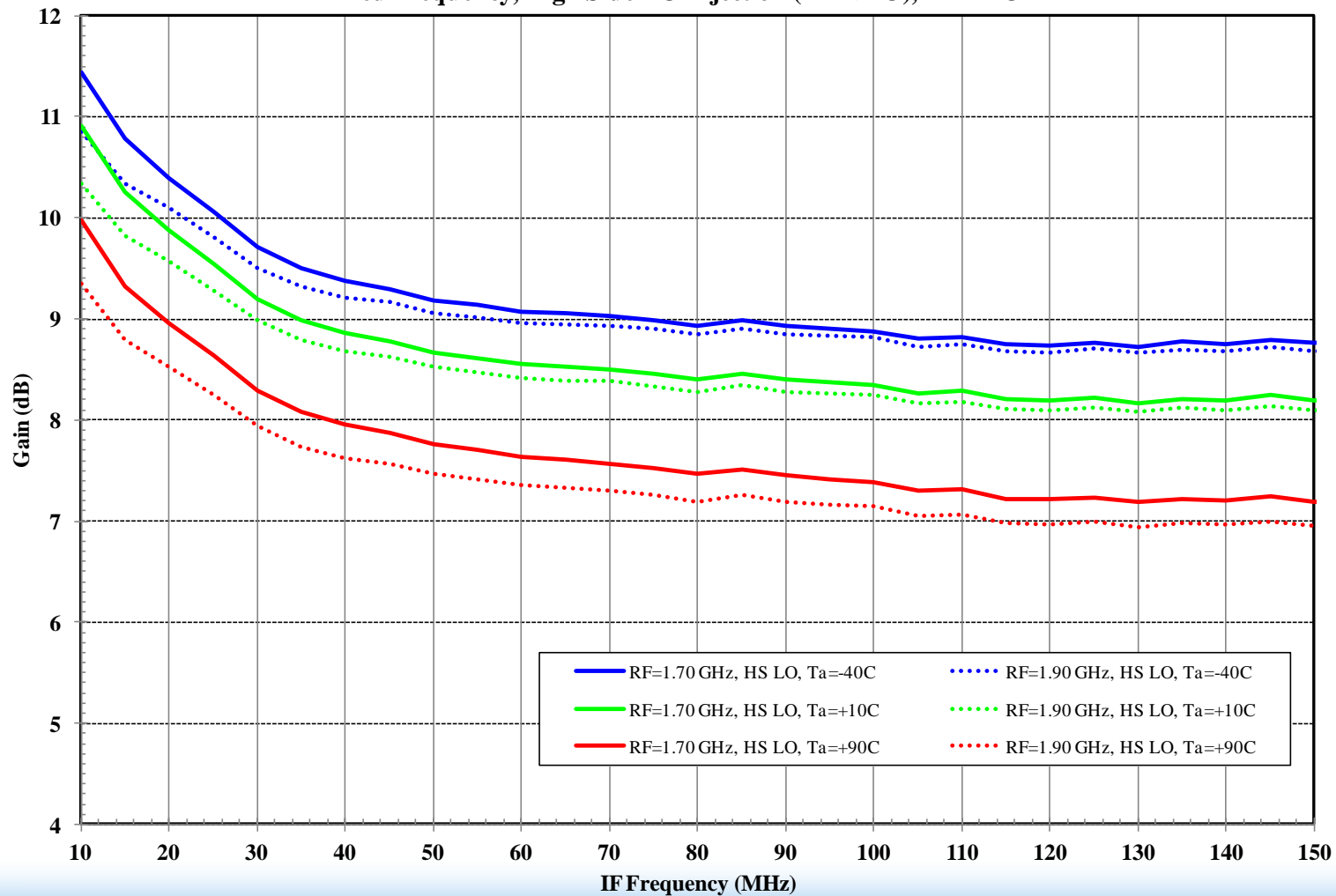

RF Match – Gain, Low Side LO

F1152 RF to IF Dual Downconverting Mixer
 $V_{cc-IF} = +3.3\text{ V}$, $V_{cc} = +5.0\text{ V}$, Low Frequency IF Circuitry, **RF Port Match**
RF Fixed Frequency, Low Side LO Injection (RF > LO), IF = RF - LO

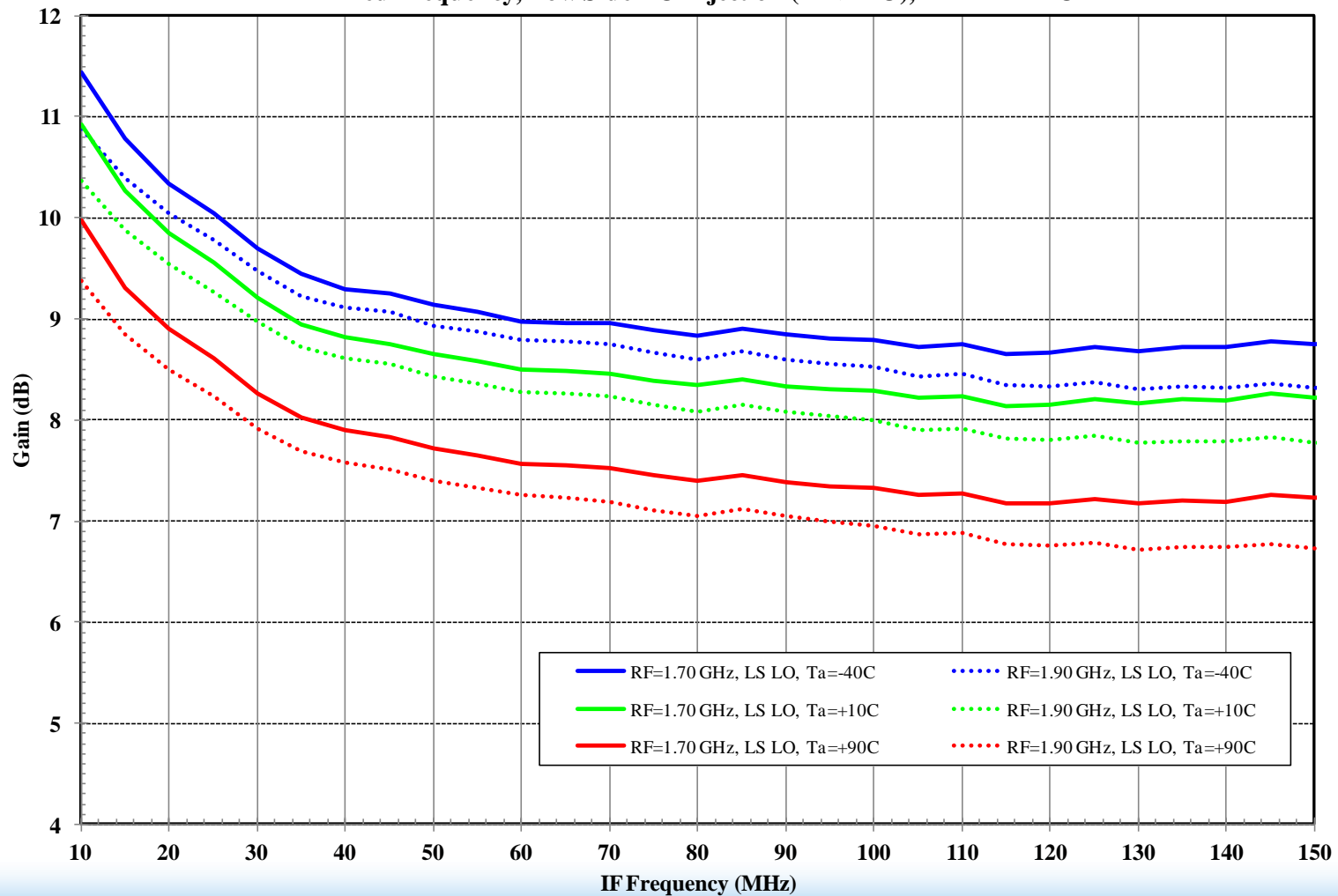

RF Match – OIP3, High Side LO

F1152 RFto IF Dual Downconverting Mixer
Vcc-IF= +3.3 V, Vcc = +5.0 V, Low Frequency IF Circuitry, **RF Port Match**
RF Fixed Frequency, High Side LO Injection (RF < LO), IF = LO - RF

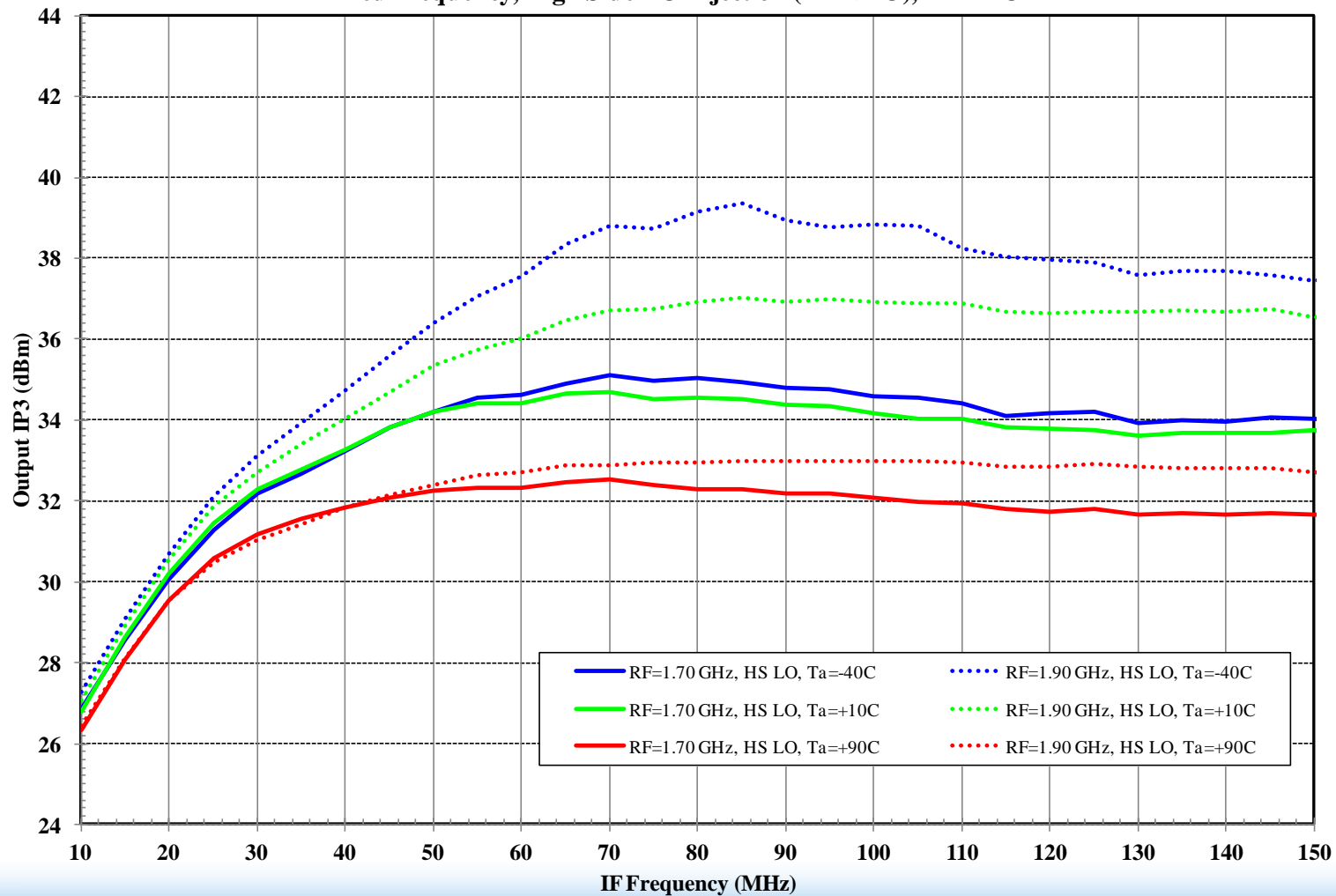

RF Match – OIP3, Low Side LO

F1152 RFto IF Dual Downconverting Mixer
 $V_{cc-IF} = +3.3\text{ V}$, $V_{cc} = +5.0\text{ V}$, Low Frequency IF Circuitry, **RF Port Match**
RF Fixed Frequency, Low Side LO Injection (RF > LO), IF = RF - LO

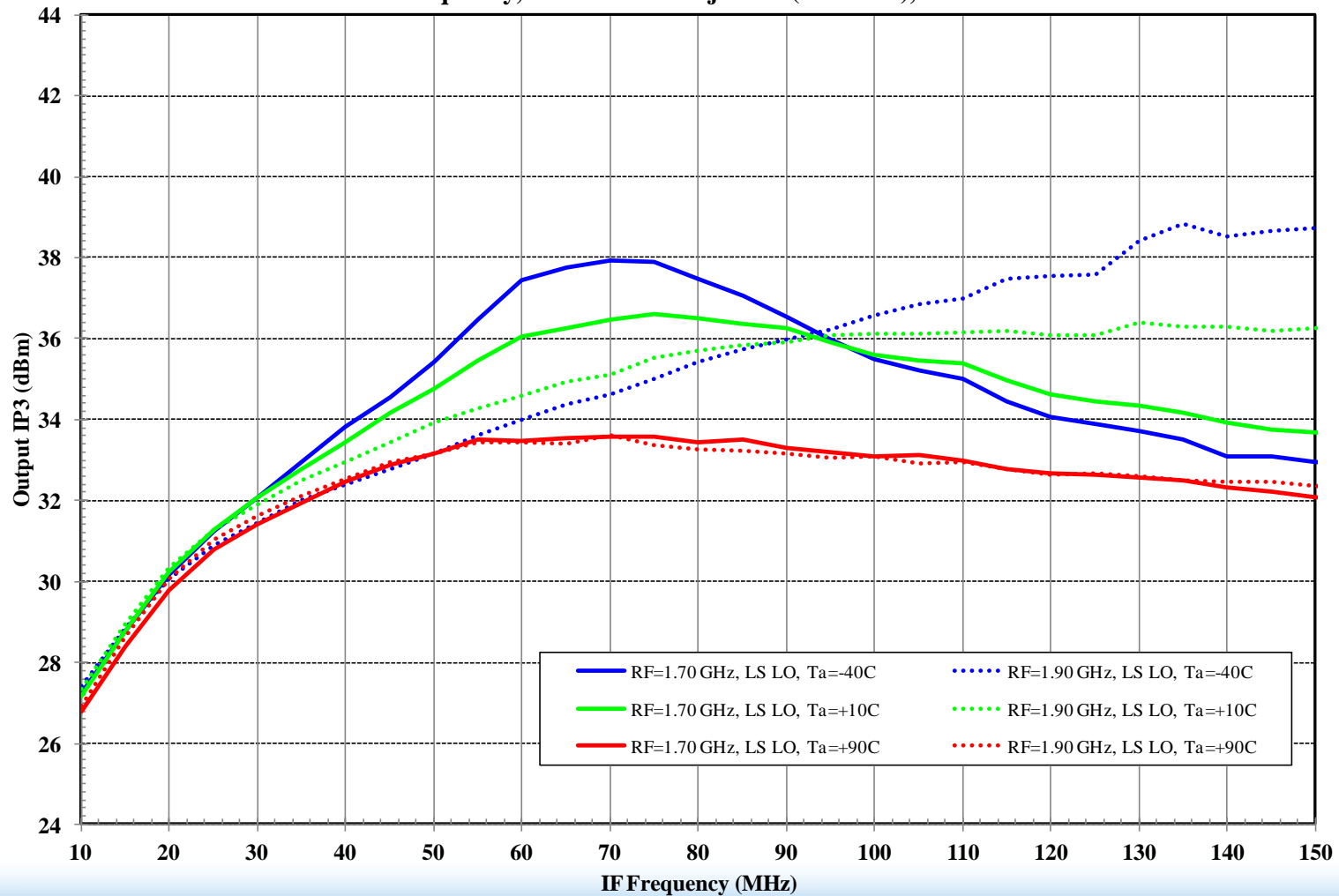

RF Match – IIP3, High Side LO

F1152 RF to IF Dual Downconverting Mixer
 $V_{cc-IF} = +3.3\text{ V}$, $V_{cc} = +5.0\text{ V}$, Low Frequency IF Circuitry, **RF Port Match**
RF Fixed Frequency, High Side LO Injection ($RF < LO$), $IF = LO - RF$

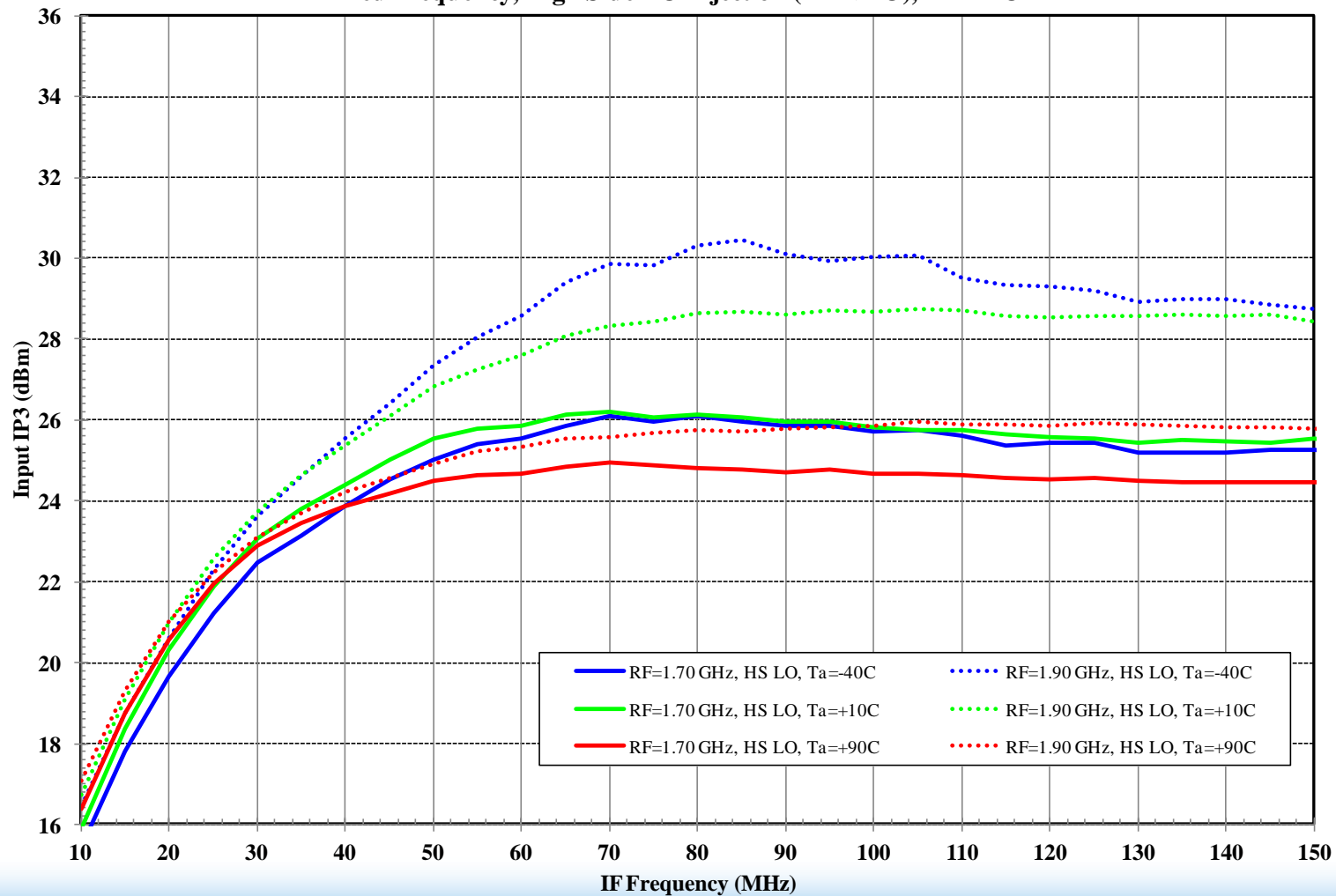

RF Match – IIP3, Low Side LO

F1152 RF to IF Dual Downconverting Mixer
 $V_{cc-IF} = +3.3\text{ V}$, $V_{cc} = +5.0\text{ V}$, Low Frequency IF Circuitry, **RF Port Match**
RF Fixed Frequency, Low Side LO Injection ($RF > LO$), $IF = RF - LO$

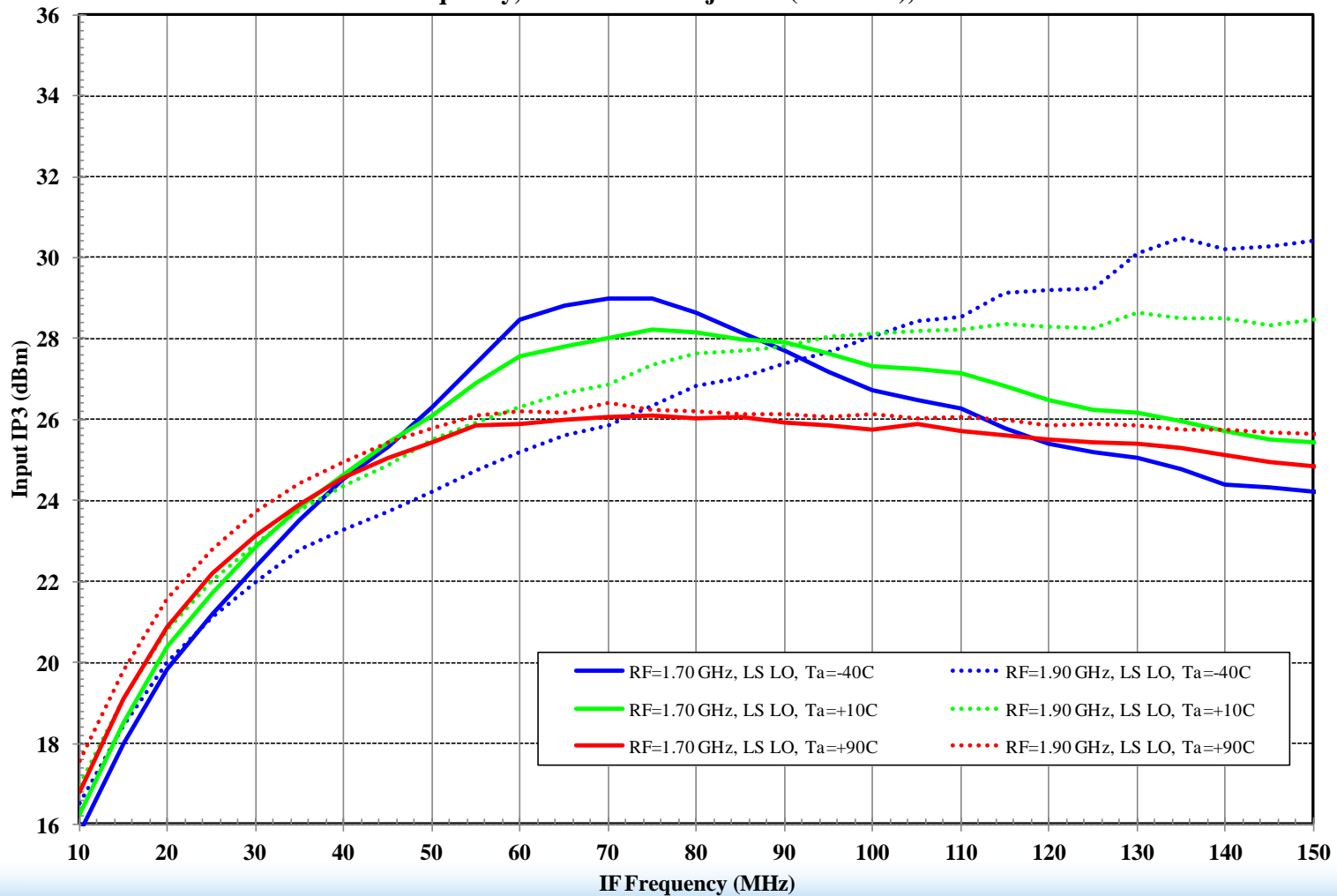

RF Match – DC Power, High Side LO

F1152 RF to IF Dual Downconverting Mixer
 $V_{cc-IF} = +3.3\text{ V}$, $V_{cc} = +5.0\text{ V}$, Low Frequency IF Circuitry, **RF Port Match**
RF Fixed Frequency, High Side LO Injection ($RF < LO$), $IF = LO - RF$

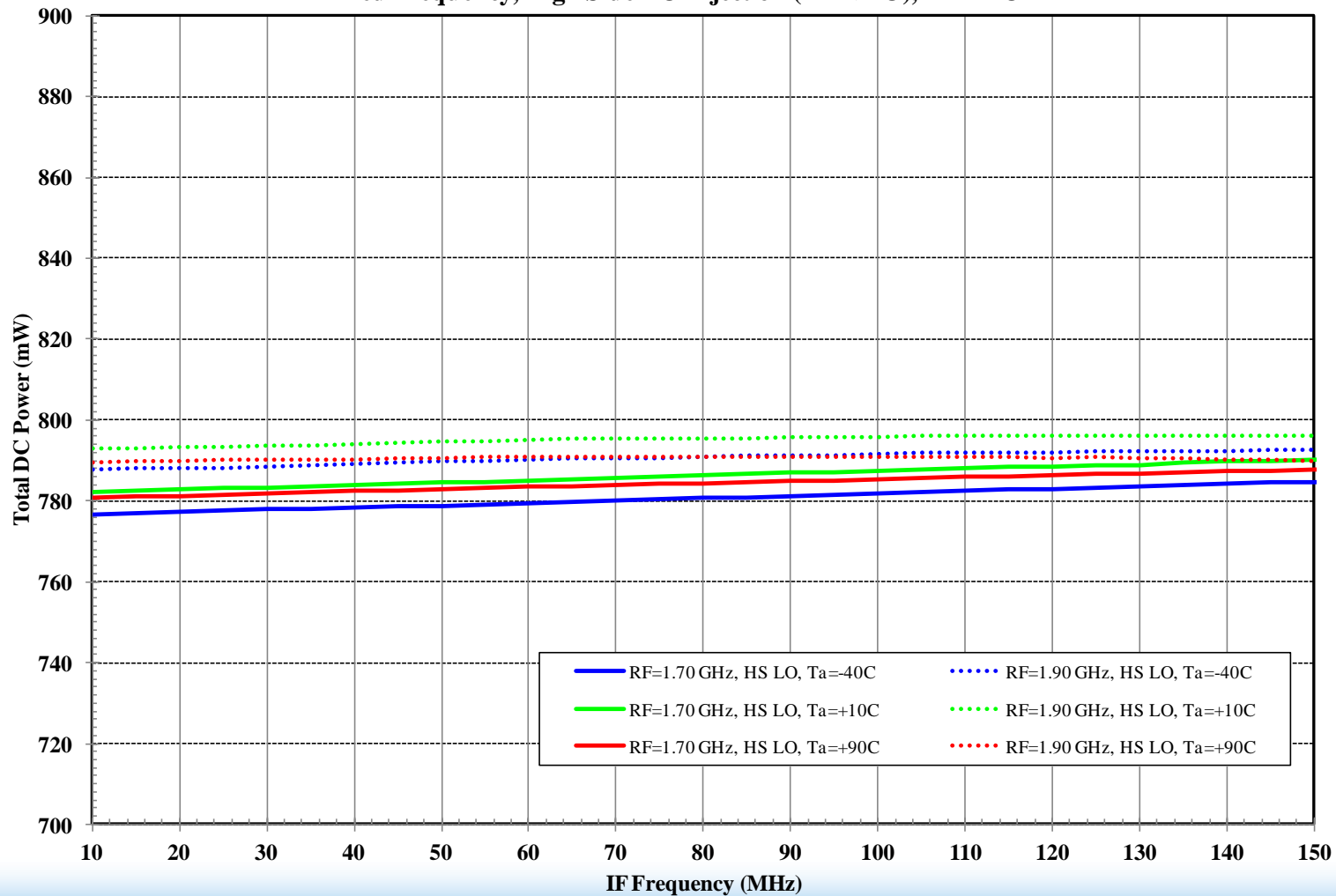

RF Match – DC Power, Low Side LO

F1152 RF to IF Dual Downconverting Mixer
 $V_{CC-IF} = +3.3\text{ V}$, $V_{CC} = +5.0\text{ V}$, Low Frequency IF Circuitry, **RF Port Match**
RF Fixed Frequency, Low Side LO Injection ($RF > LO$), $IF = RF - LO$

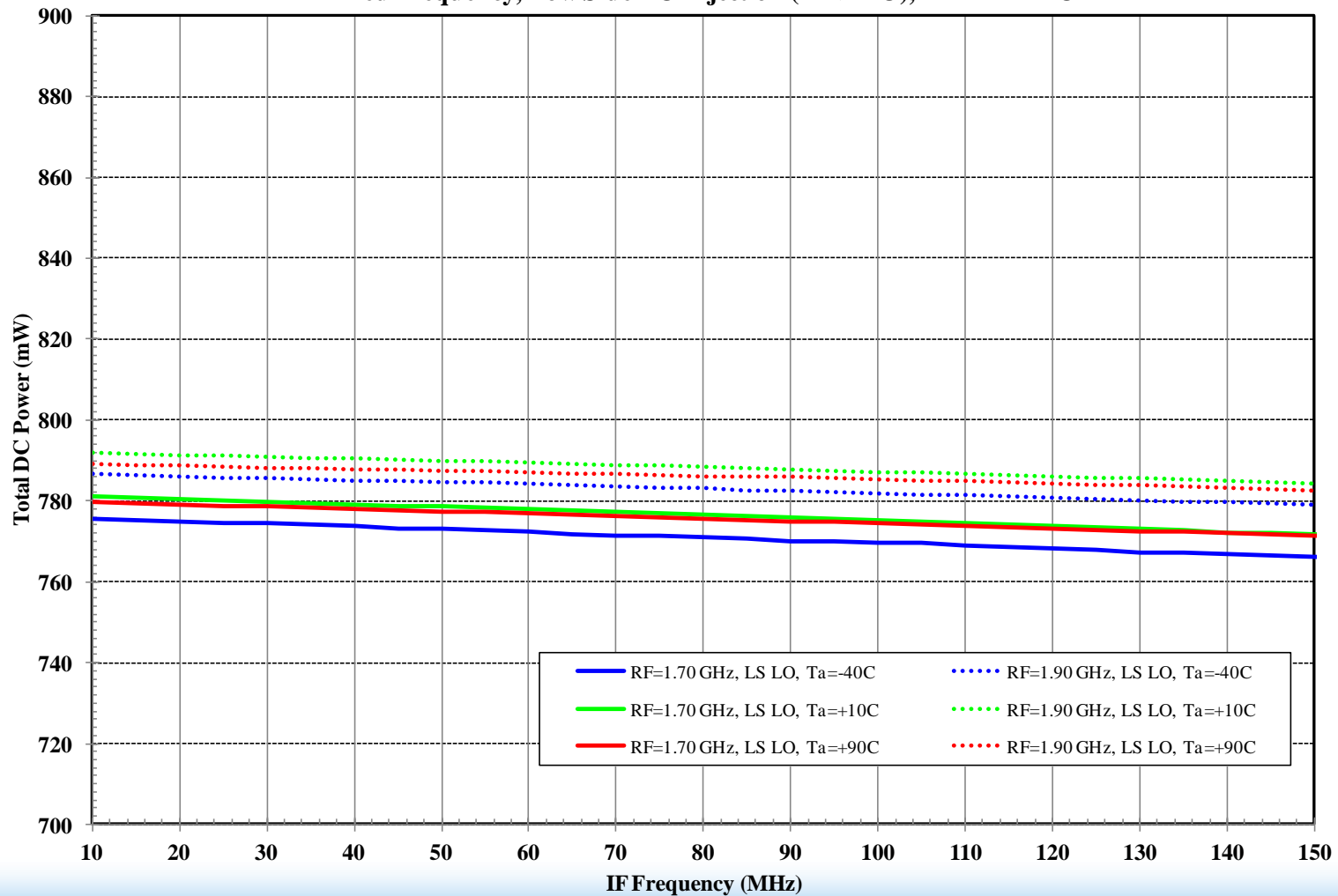

RF Match – OP1dB, High Side LO

F1152 RF to IF Dual Downconverting Mixer
V_{cc-IF} = +3.3 V, V_{cc} = +5.0 V, Low Frequency IF Circuitry, **RF Port Match**
RF Fixed Frequency, High Side LO Injection (RF < LO), IF = LO - RF

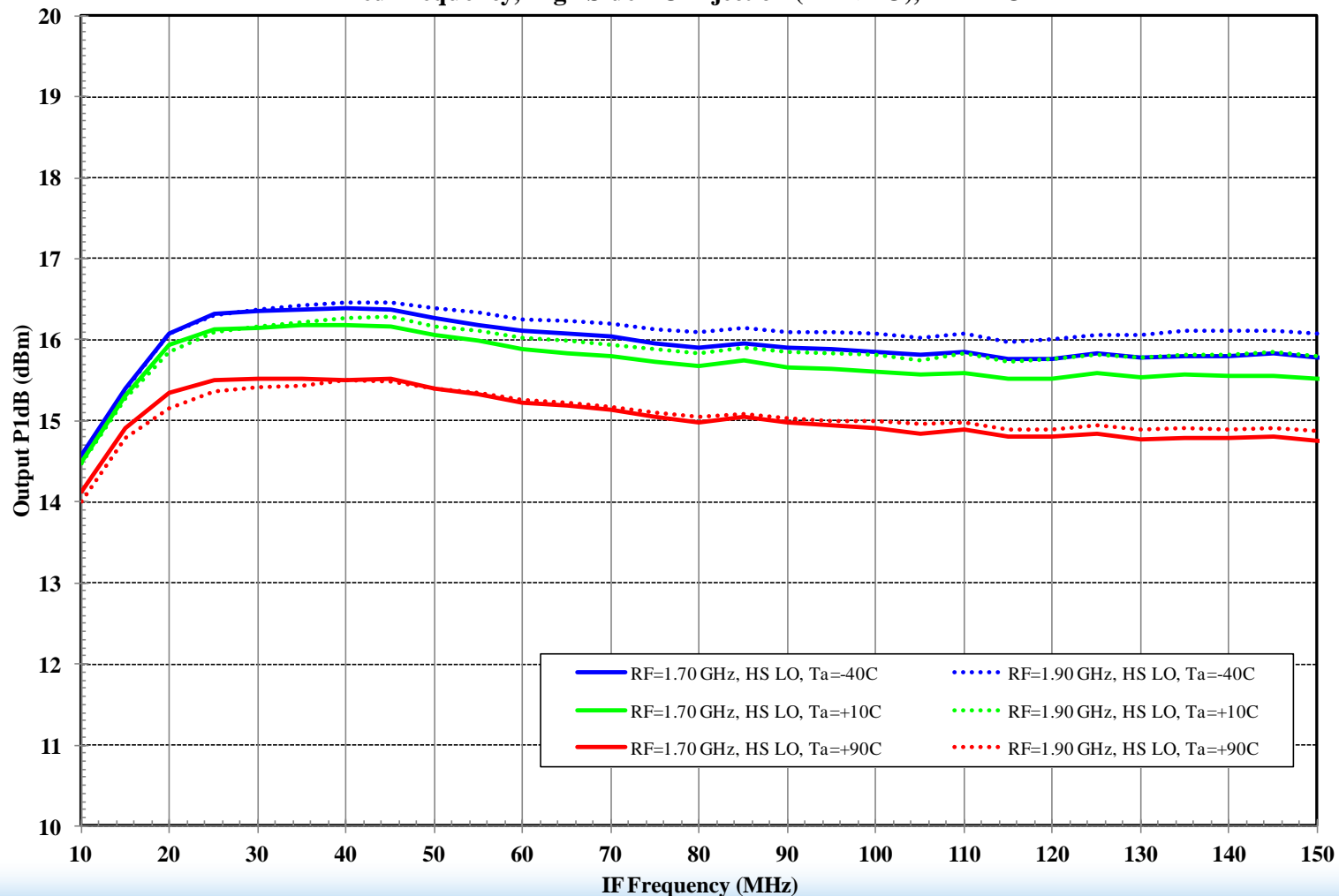

RF Match – OP1dB, Low Side LO

F1152 RF to IF Dual Downconverting Mixer
V_{cc-IF} = +3.3 V, V_{cc} = +5.0 V, Low Frequency IF Circuitry, **RF Port Match**
RF Fixed Frequency, Low Side LO Injection (RF > LO), IF = RF - LO

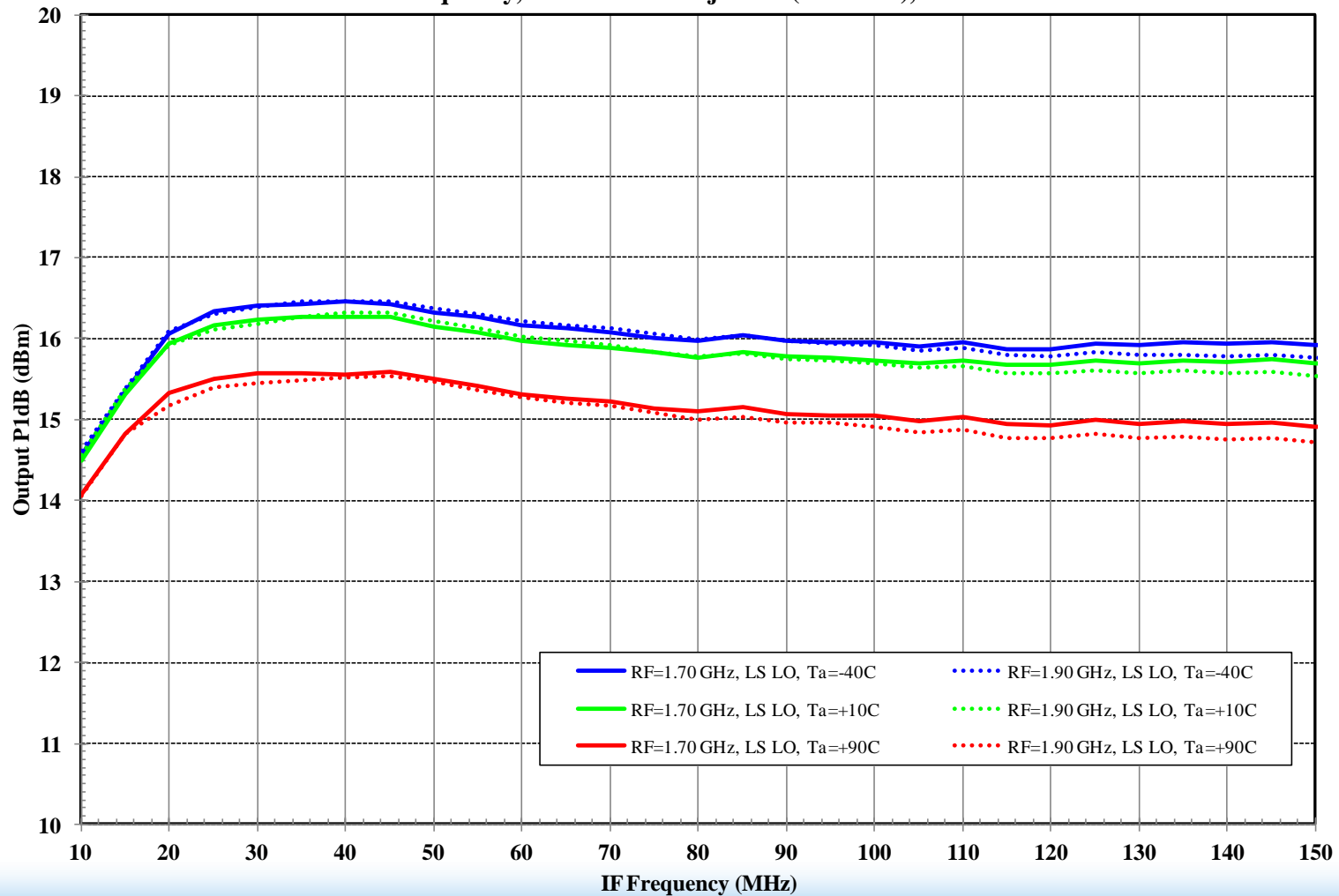

RF Match – OIP2, High Side LO

F1152 RF to IF Dual Downconverting Mixer
Vcc-IF = +3.3 V, Vcc = +5.0 V, Low Frequency IF Circuitry, **RF Port Match**
RF Fixed Frequency, High Side LO Injection (RF < LO), IF = LO - RF

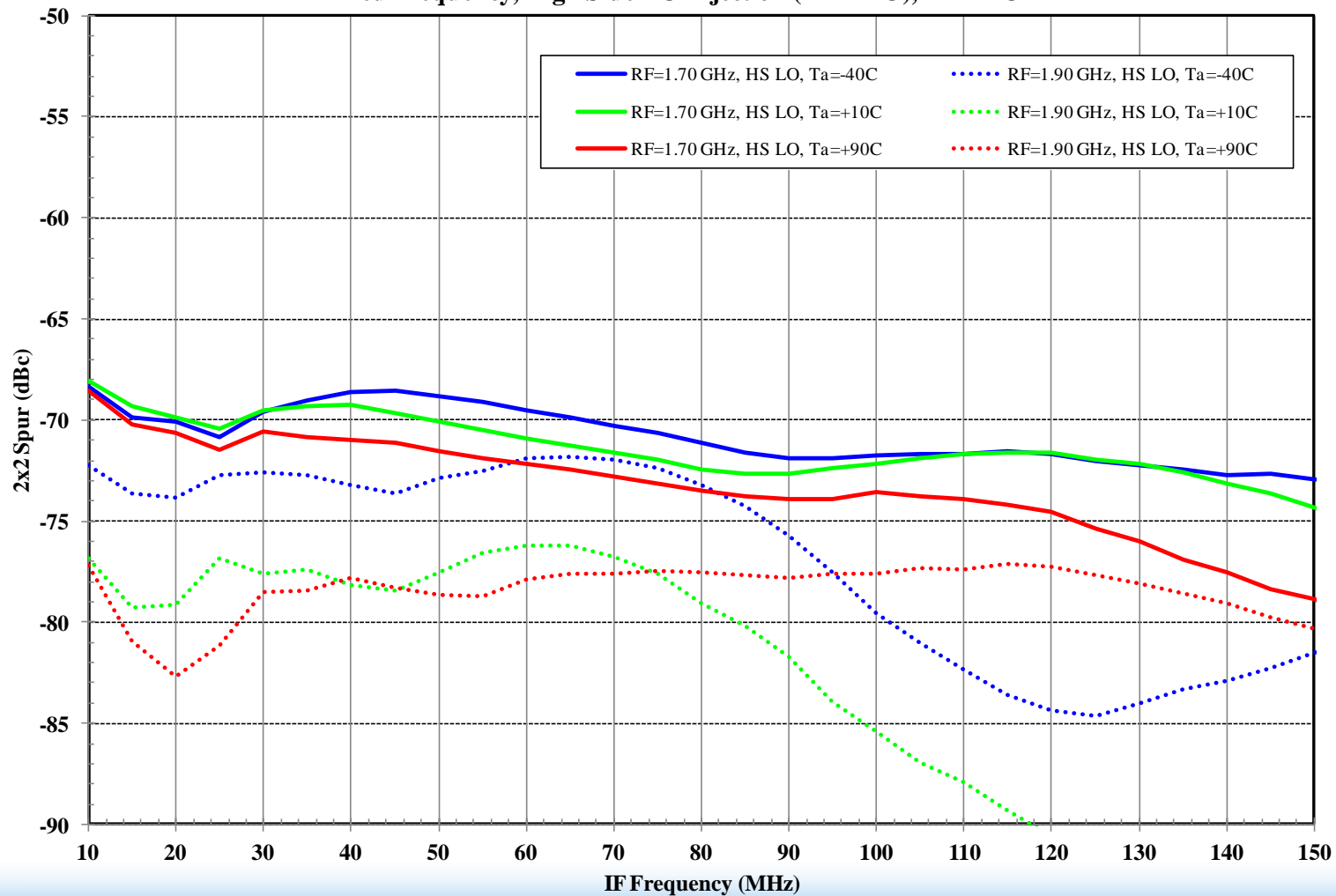

RF Match – OIP2, Low Side LO

F1152 RFto IF Dual Downconverting Mixer
Vcc-IF= +3.3 V, Vcc = +5.0 V, Low Frequency IF Circuitry, **RF Port Match**
RF Fixed Frequency, Low Side LO Injection (RF > LO), IF = RF - LO

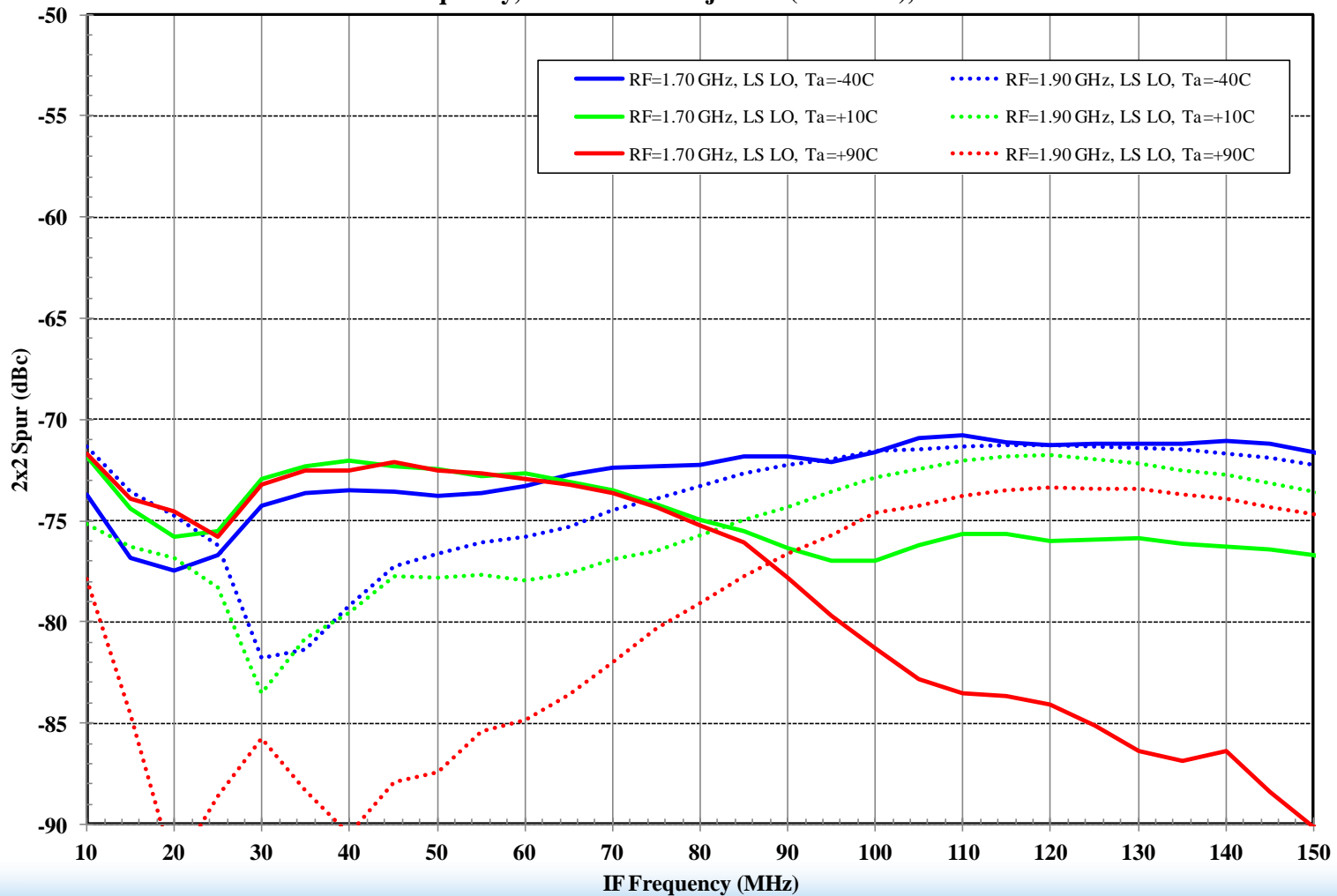

RF Match – 2x2 Rejection, High Side LO

F1152 RF to IF Dual Downconverting Mixer
Vcc-IF= +3.3 V, Vcc = +5.0 V, Low Frequency IF Circuitry, **RF Port Match**
RF Fixed Frequency, High Side LO Injection (RF < LO), IF = LO - RF

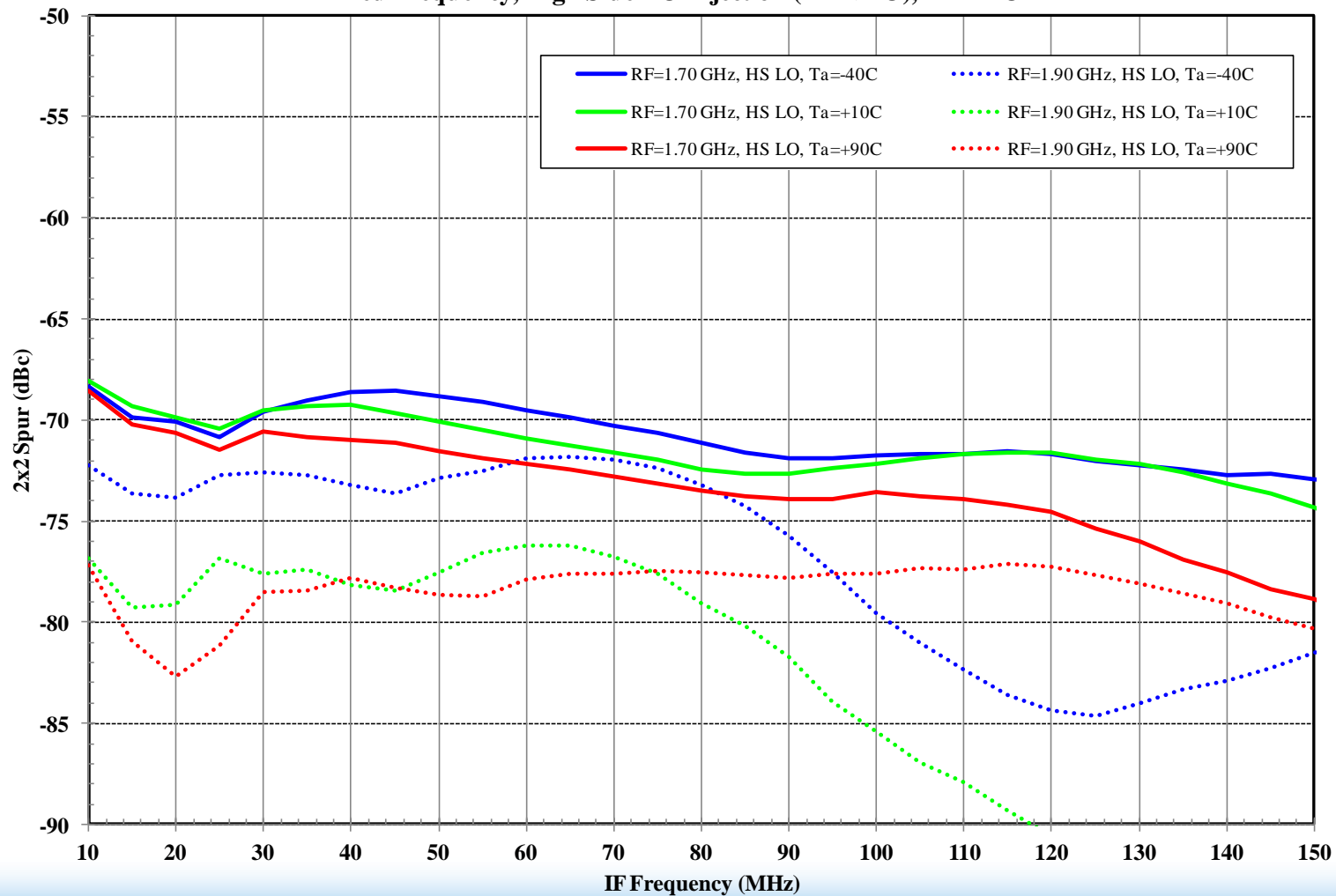

RF Match – 2x2 Rejection, Low Side LO

F1152 RF to IF Dual Downconverting Mixer
 $V_{cc-IF} = +3.3\text{ V}$, $V_{cc} = +5.0\text{ V}$, Low Frequency IF Circuitry, **RF Port Match**
RF Fixed Frequency, Low Side LO Injection ($RF > LO$), $IF = RF - LO$

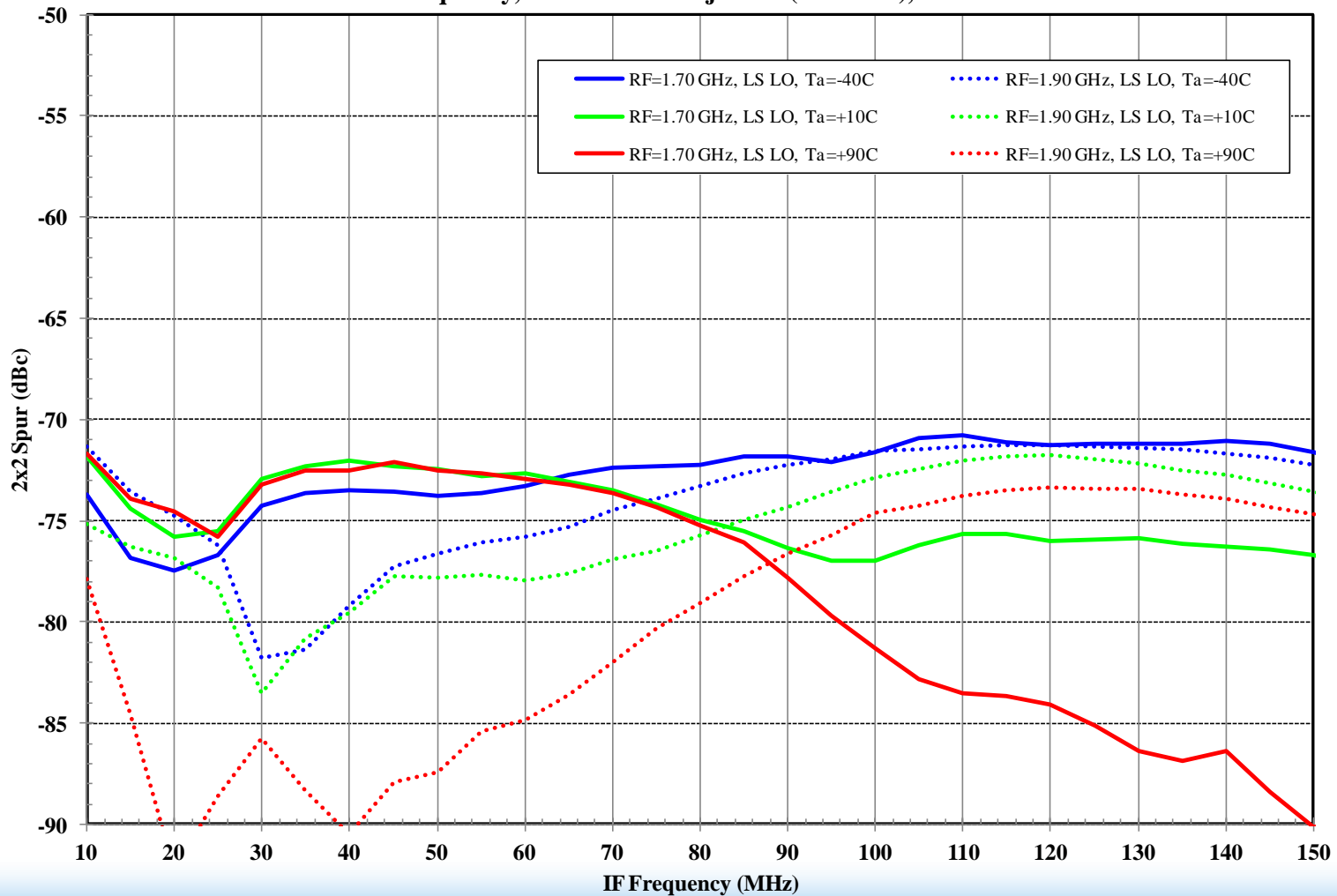

RF Match – 3x3 Rejection, High Side LO

F1152 RF to IF Dual Downconverting Mixer
Vcc-IF= +3.3 V, Vcc = +5.0 V, Low Frequency IF Circuitry, **RF Port Match**
RF Fixed Frequency, High Side LO Injection (RF < LO), IF = LO - RF

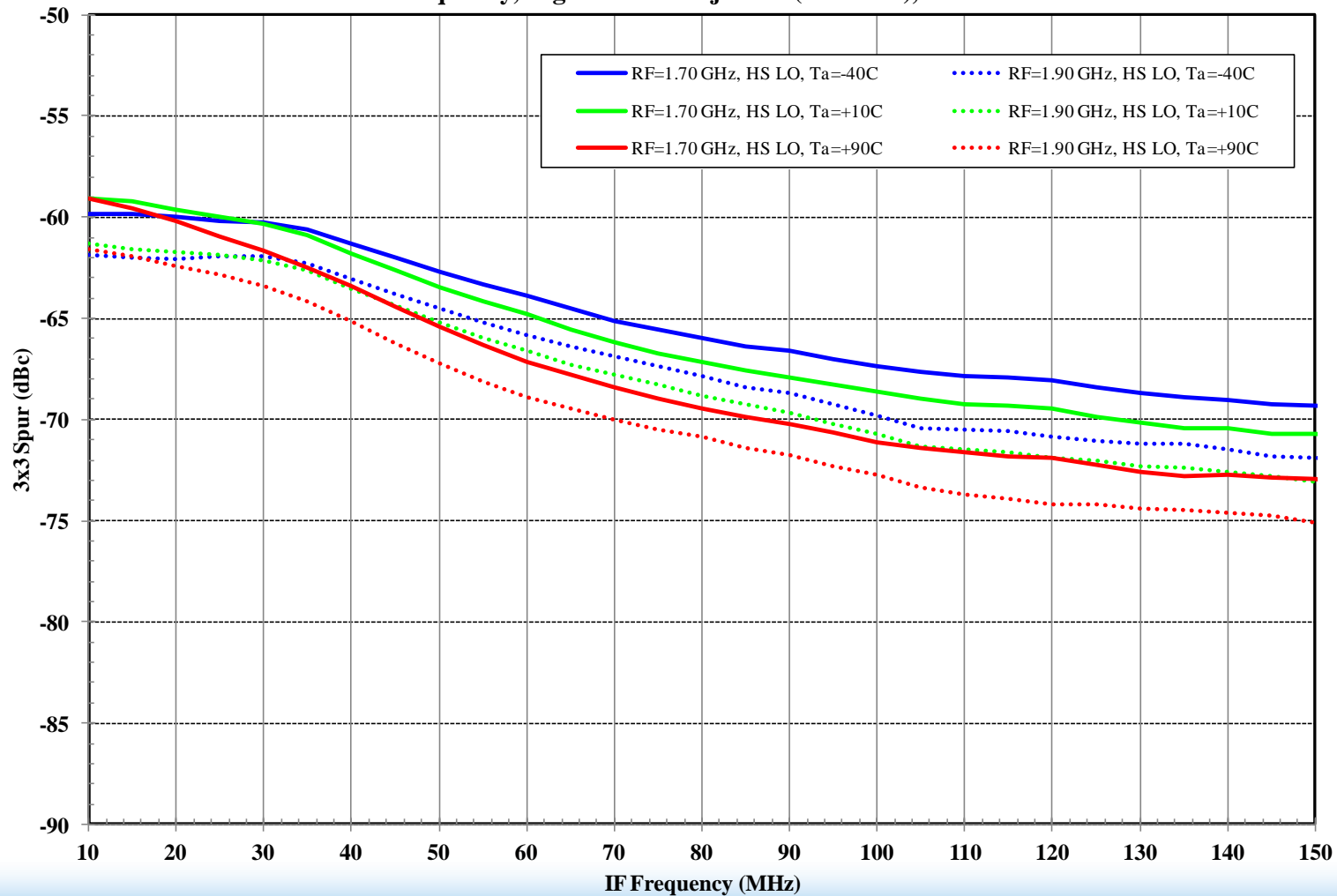

RF Match– 3x3 Rejection, Low Side LO

F1152 RF to IF Dual Downconverting Mixer
Vcc-IF= +3.3 V, Vcc = +5.0 V, Low Frequency IF Circuitry, **RF Port Match**
RF Fixed Frequency, Low Side LO Injection (RF > LO), IF = RF - LO

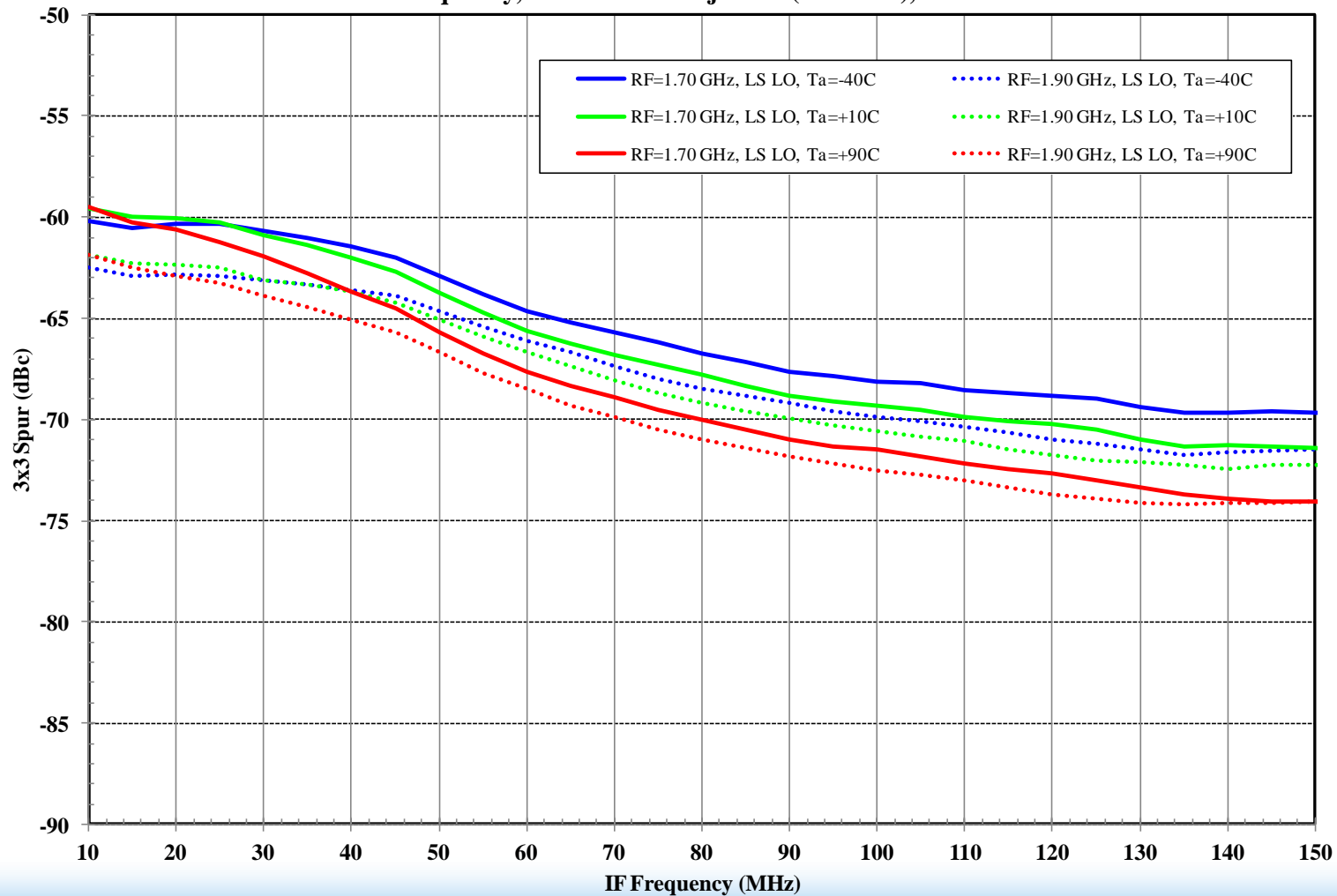

IF Circuit Modifications

- Customer modified the IF circuit to move the balanced circuitry to the other side of the balun.
- This modification could not be done because
 - It assumes a balanced configuration and IDT's evaluation board is single-ended.
 - There is not enough room between the balun and evaluation board connector to place the elements.

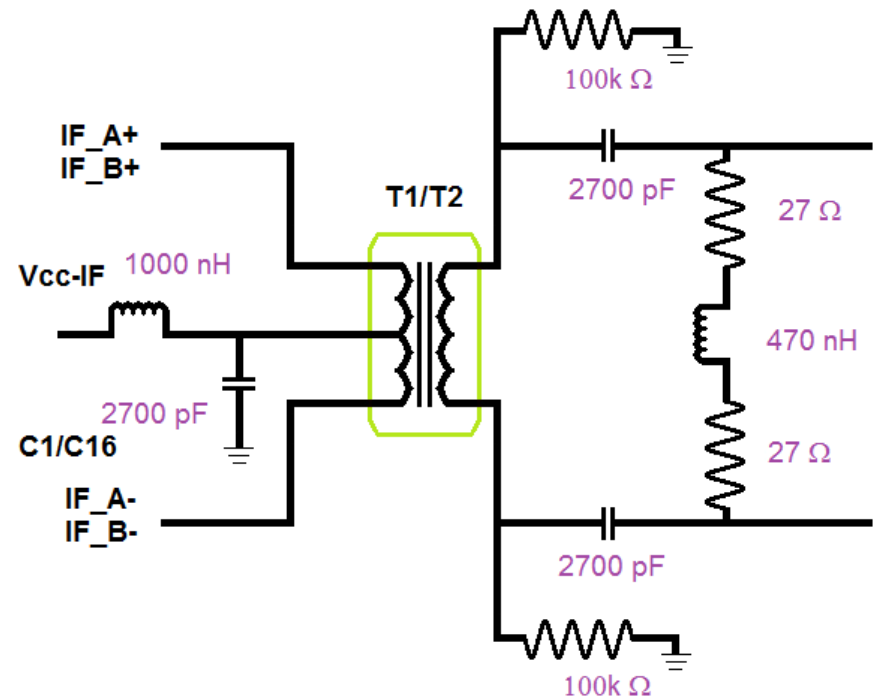

Comparison – Gain

F1152 RF to IF Dual Downconverting Mixer
V_{cc-IF} = +3.3 V, V_{cc} = +5.0 V, RF Fixed Frequency,
Comparison of the Gain at Room Temperature

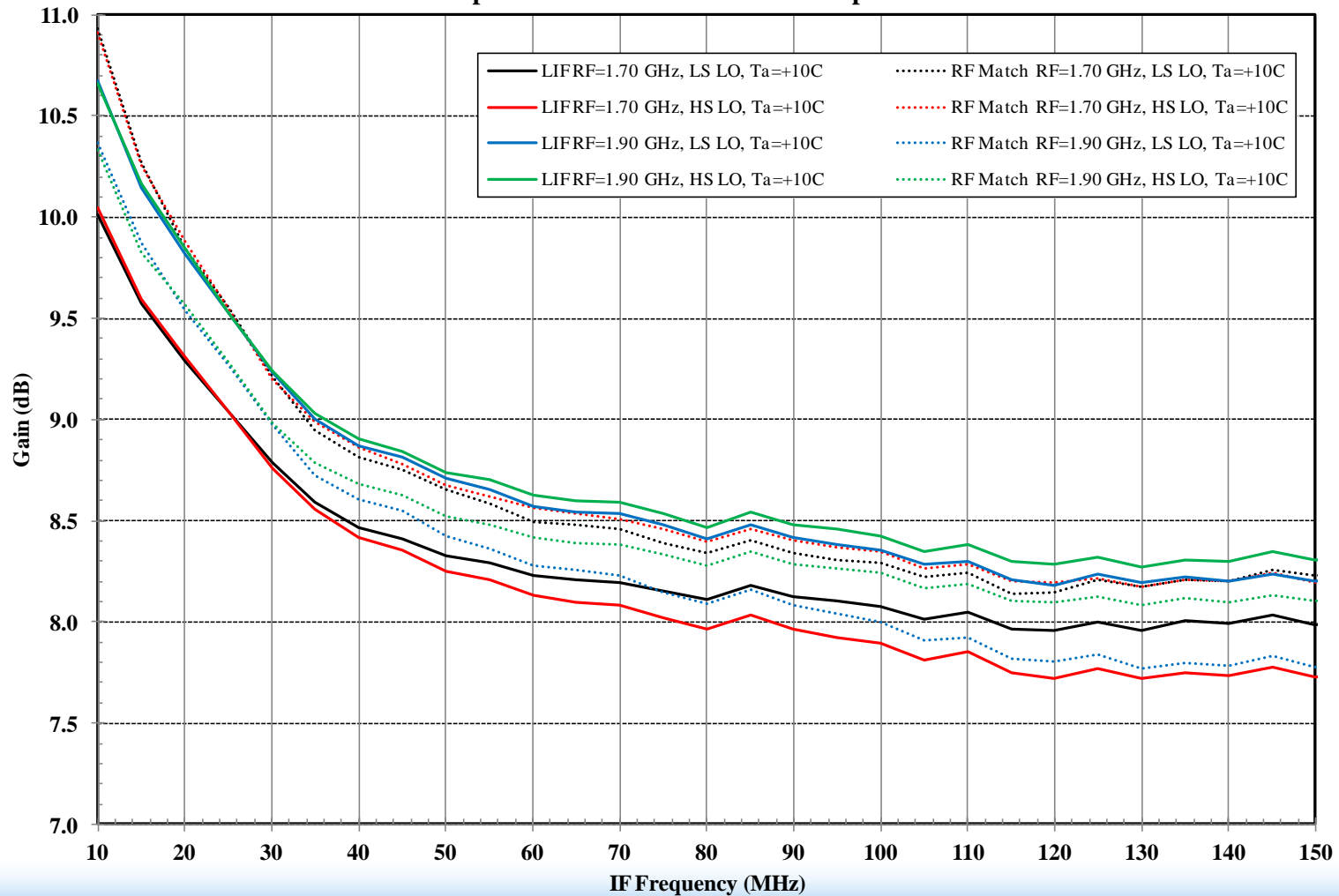

Comparison – OIP3

F1152 RF to IF Dual Downconverting Mixer
V_{cc-IF} = +3.3 V, V_{cc} = +5.0 V, RF Fixed Frequency,
Comparison of the Output IP3 at Room Temperature

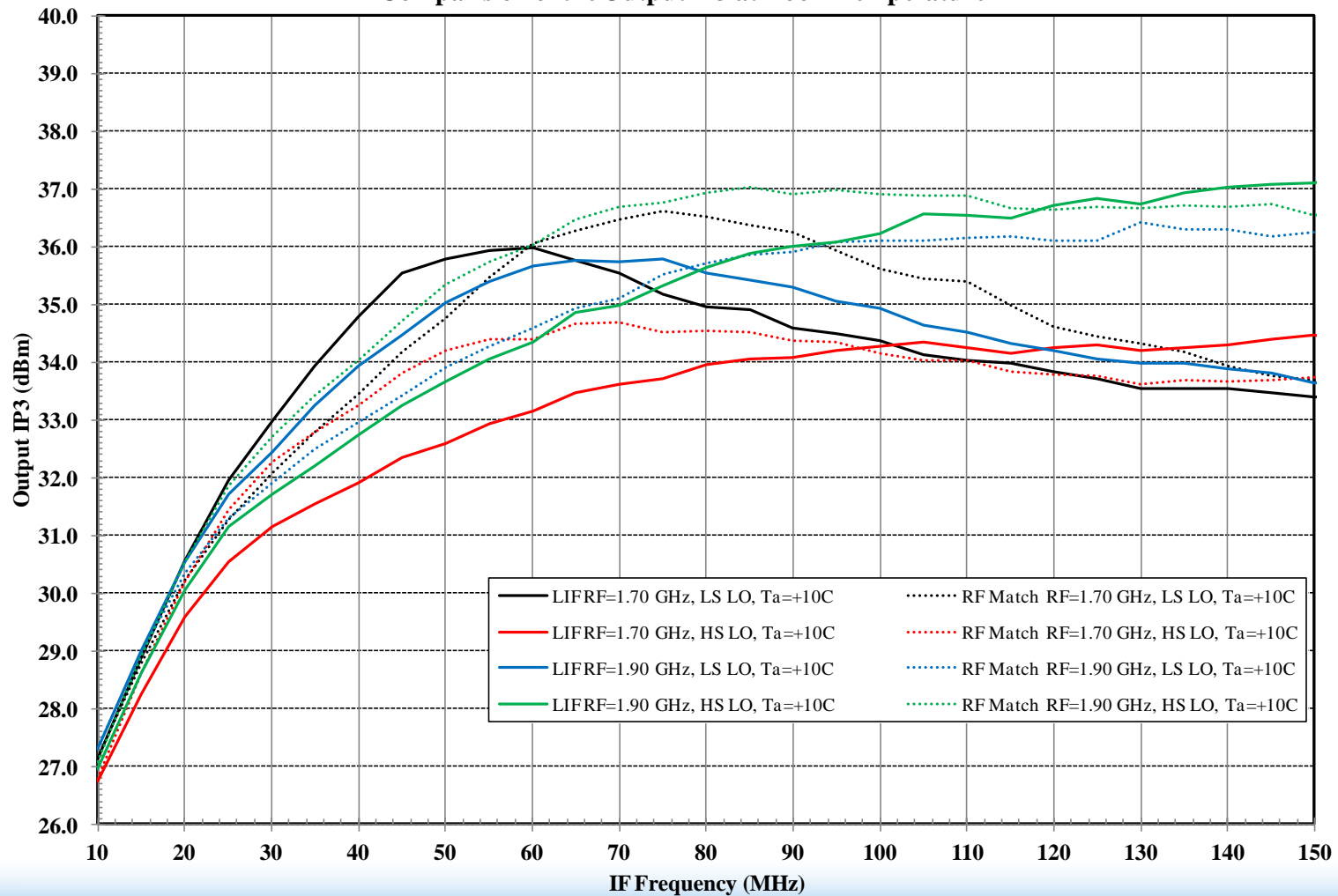

Comparison – OP1dB

F1152 RF to IF Dual Downconverting Mixer
Vcc-IF= +3.3 V, Vcc = +5.0 V, RF Fixed Frequency,
Comparison of the Output P1dB at Room Temperature

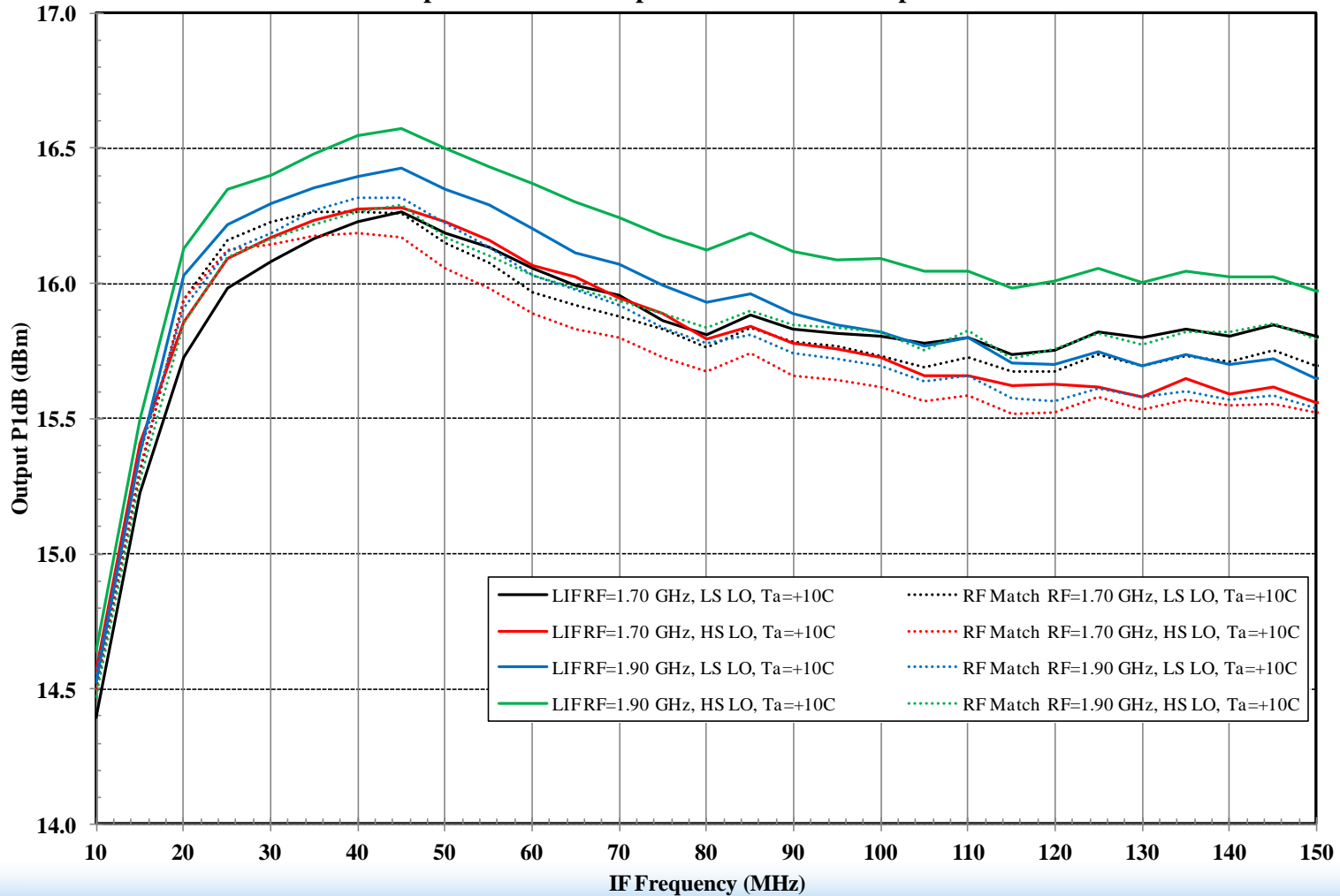

RF Match – Measurement Parameters

- The measurements were done exactly the same as the Low IF circuitry testing



Conclusion

- As compared to the 2013 report, the data is very similar and within process variation.
- The electrical performance is similar for both low and high side LO injection.
- The RF Match had the following affect:
 - Gain increase at 1.7 GHz and decrease at 1.9 GHz. It was less than 0.25 dB.
 - OIP3 was the same or increased.
 - OP1dB decreased by less than 0.25 dB.
- The RF matching circuit does not have significant effect on the downconverter electrical performance.

