

SECTION "X-X"
TRAY STACKING DETAIL
SCALE : 3/1

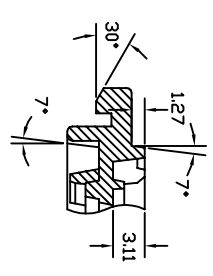

DETAIL "H"
SCALE : 4/1

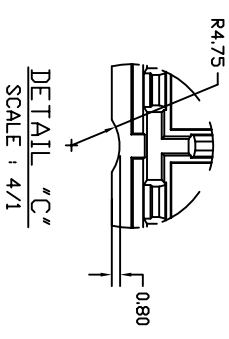

DETAIL "C"
SCALE : 4/1

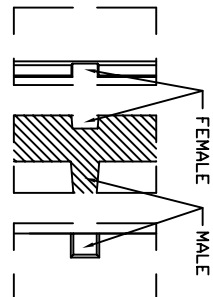

SLIP-LOCK DETAILS
DETAIL "D"
SCALE : 4/1

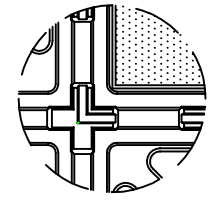

BOTTOM VIEW
DETAIL "G"
SCALE : 4/1

NOTES : (UNLESS OTHERWISE SPECIFIED)
1. NUMBER OF POCKET : 5 X 12 = 60 POCKETS

TOLERANCES UNLESS OTHERWISE SPECIFIED		WWW.IDT.COM		6024 Silver Creek Valley Road, San Jose, CA 95138 PHONE: (408) 284-8200 FAX: (408) 284-3572	
DECIMAL	ANGLE	DATE	APPROVALS	STOCK NO.	SCALE
.XX ± .10				N/A	N/A
TITLE:			DRAWING NO.		
BC/BCG/BL/BLG/BR 484, BX/BXG			MSC-5719-A		
288 & HL/HLG 484 SHIPPING TRAY			REV		
			00		
DO NOT SCALE DRAWING			SHEET 1 OF 2		

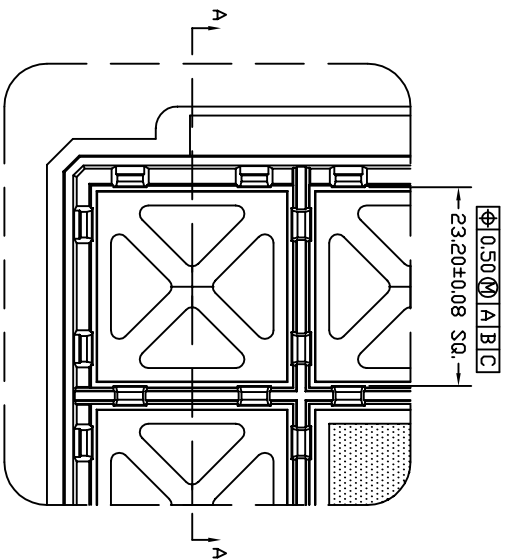

TOP VIEW
DETAIL "B"
SCALE : 3/1
(FROM SHT.#1)

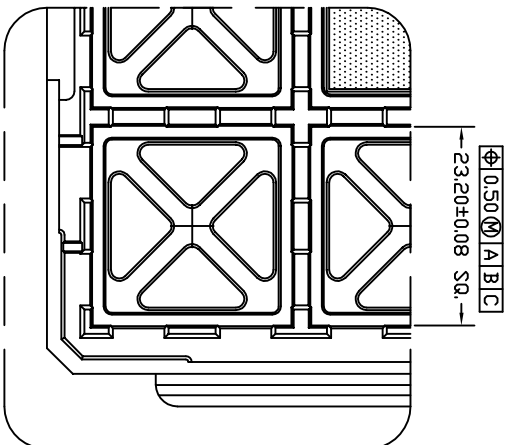

BOTTOM VIEW
DETAIL "B"
SCALE : 3/1
(FROM SHT.#1)

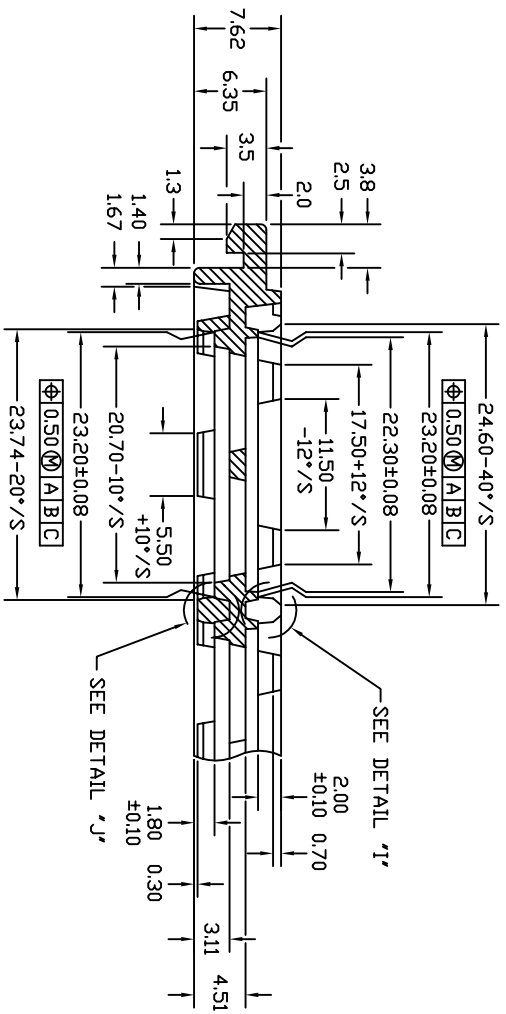

SECTION "A-A"
SCALE : 4/1

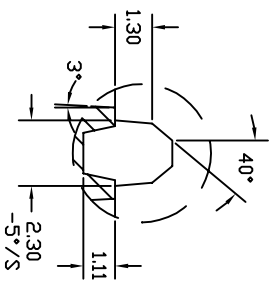

DETAIL "I"
SCALE : 10/1

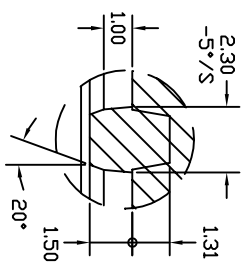

DETAIL "J"
SCALE : 10/1

TOLERANCES UNLESS OTHERWISE SPECIFIED
DECIMAL
X ± .10
XX ± .10
ANGLE



6024 Silver Creek Valley Road,
San Jose, CA 95138
PHONE: (408) 284-8200
FAX: (408) 284-3572

WWW.IDT.COM
TITLE: BC/BCG/BL/BLG/BR 484, BX/BXG
288 & HL/HLG 484 SHIPPING TRAY

APPROVALS	DATE	SCALE
DRAWN		N/A
STOCK NO.	DRAWING NO.	REV
N/A	MSC-5719-A	00
DO NOT SCALE DRAWING		SHEET 2 OF 2