

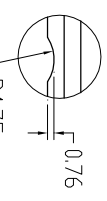

322.6(L)  
315.0(A) Δ  
6-ND HOLES  
(VACUUM PICKUP CELLS)

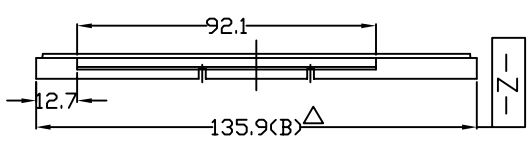

NOTE: SCALLOP IS CENTERED ON SIDE OF TRAY  
DETAIL C

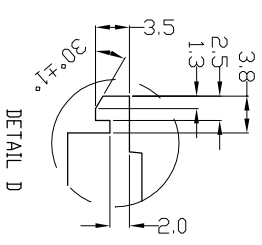
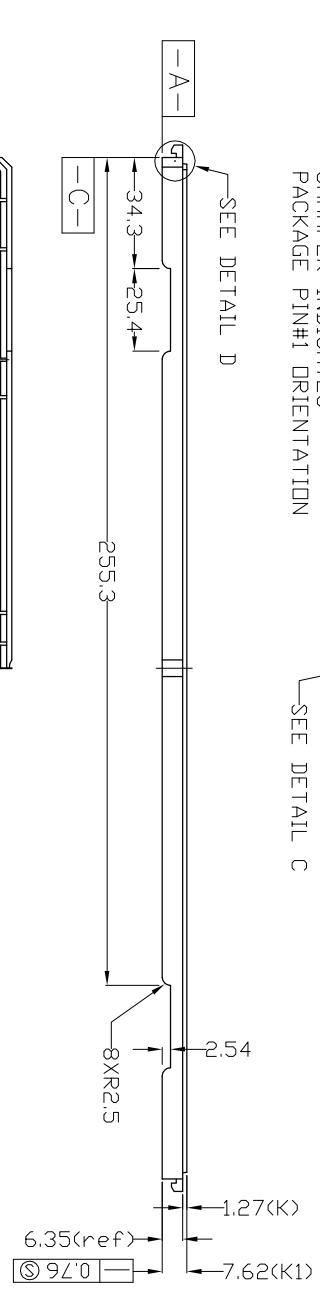
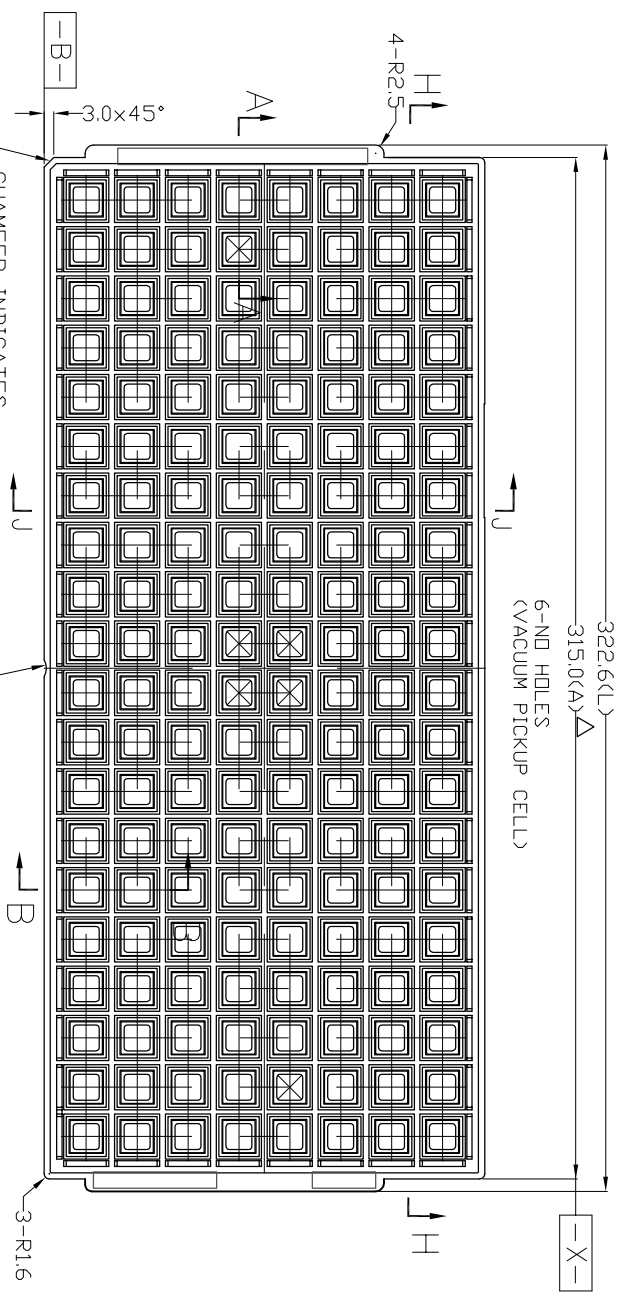
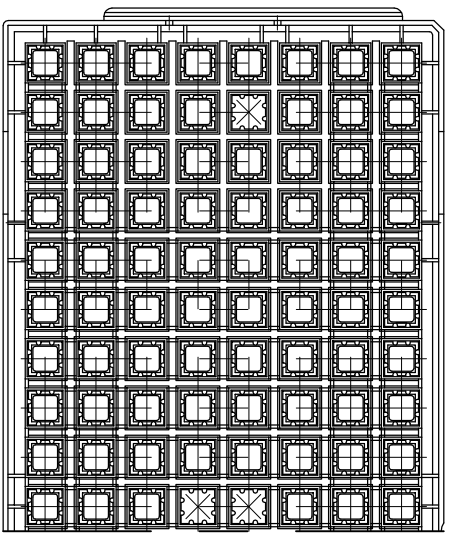

TOLERANCES UNLESS OTHERWISE SPECIFIED  
DECIMAL : X ±.25  
          XX ±.13  
          XXX ±.13  
ANGLE : ±  
ANGULAR : ±



6024 Silver Creek Valley Road,  
San Jose, CA 95138  
PHONE: (408) 284-8200  
FAX: (408) 284-3572

TITLE:  
DE/DEG 64 & ED/EDG 64  
SHIPPING TRAY

SCALE  
N/A  
SIZE  
N/A

STOCK NO. N/A  
DRAWING NO. MSC-7045-A  
REV 00

DO NOT SCALE DRAWING SHEET 1 OF 2

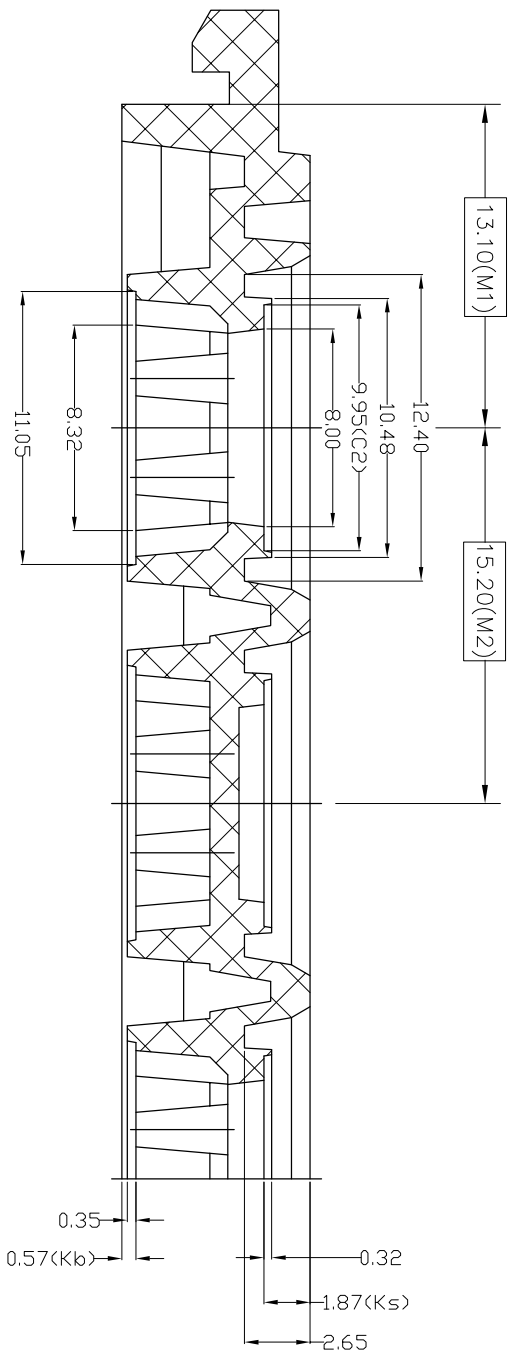

SECTION A-A

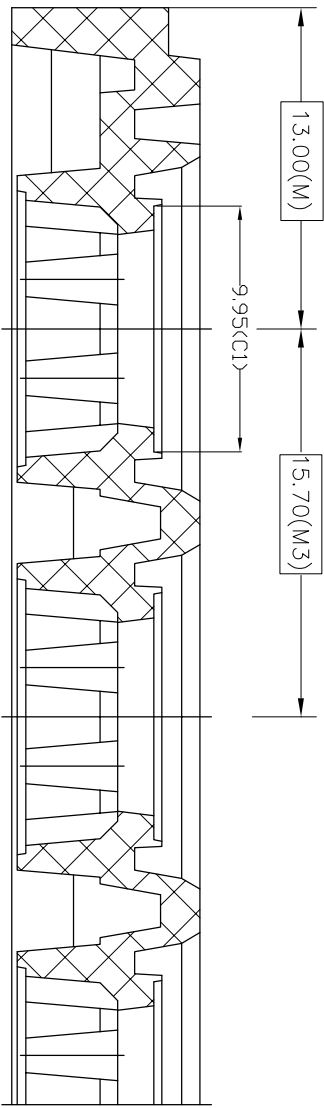

SECTION B-B

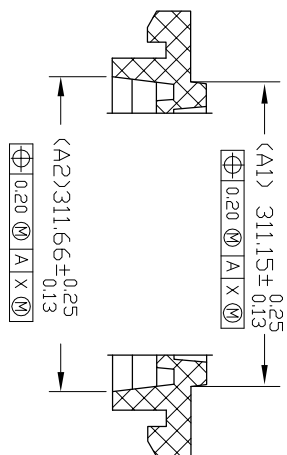

SECTION H-H

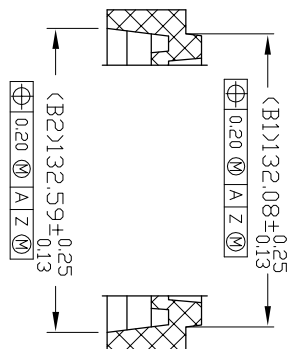

SECTION J-J

TOLERANCES UNLESS OTHERWISE SPECIFIED  
 DECIMAL : X ±.25  
 .XX ±.13  
 .XXX ±.13  
 ANGLE : ±  
 ANGULAR : ±

**IDT**  
 www.IDT.com  
 6024 Silver Creek Valley Road,  
 San Jose, CA 95138  
 PHONE: (408) 284-8200  
 FAX: (408) 284-3572

TITLE:		DE/DEG 64 & ED/EDG 64		SCALE	N/A
STOCK NO.		N/A		SIZE	N/A
DRAWING NO.		MSC-7045-A		REV	00
DO NOT SCALE DRAWING		SHEET 2 OF 2			