

REVISIONS			
REV	DESCRIPTION	DATE	APPROVED
03	REDRAW TO JEDEC FORMAT	03/15/95	
04	ADD "GREEN" PUG NOMENCLATURE	10/12/04	TU VU
05	ADD PACKAGE CODE	12/12/12	RC

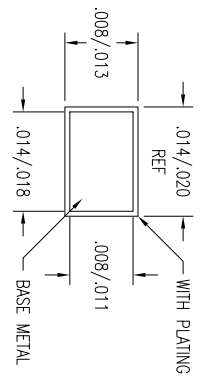
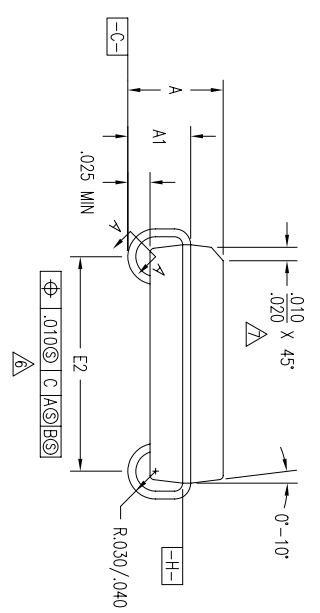
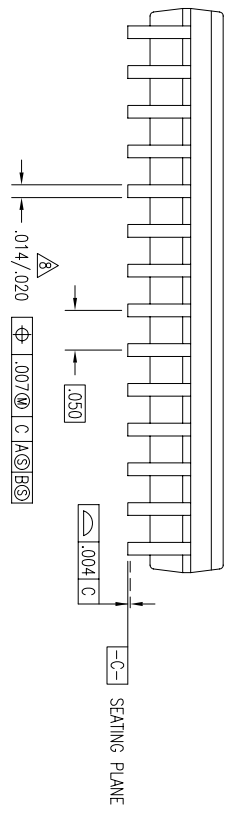
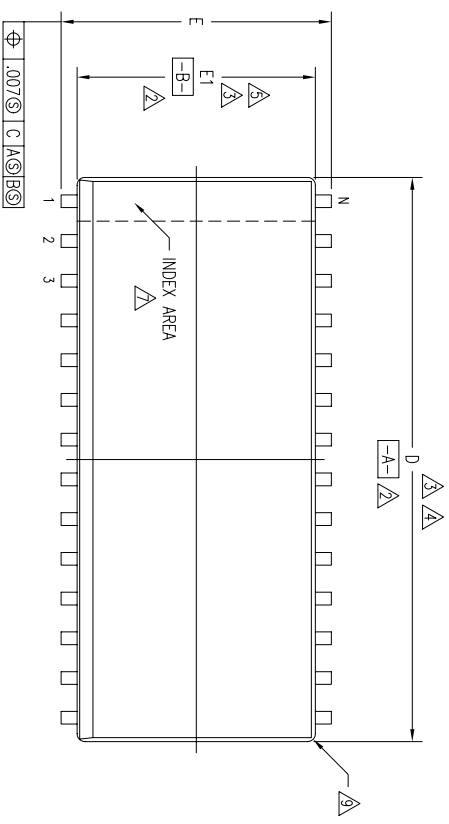
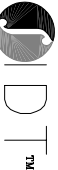

SECTION A-A

TOLERANCES UNLESS SPECIFIED			
DECIMAL	ANGULAR	6024 SILVERCREEK VALLEY RD SAN JOSE CA 95138 PHONE: (408) 284-8200 FAX: (408) 284-8591	
XXX±	±	www.IDT.com	
XXXX±		PUG/PUG 20 & 28 PACKAGE OUTLINE	
XXXX±		.300" BODY WIDTH SOJ	
XXXX±		.050" PITCH	
APPROVALS	DATE	SIZE	DRAWING No.
DRAWN		C	PSC-4024
CHECKED			
DO NOT SCALE DRAWING		SHEET	1 OF 2

REVISIONS			
REV	DESCRIPTION	DATE	APPROVED
03	REDRAW TO JEDEC FORMAT	03/15/95	TU VU
04	ADD "GREEN" PJG NOMENCLATURE	10/12/04	TU VU
05	ADD PACKAGE CODE	12/12/12	RC

LAND PATTERN DIMENSIONS

SYMBOL	PJ/PJG20			PJ/PJG28		
	JEDEC VARIATION			JEDEC VARIATION		
	AD	N P T E		AF	N P T E	
A	MIN	NOM	MAX	MIN	NOM	MAX
A	.120	.130	.140	.120	.130	.140
A1	.078	.086	.095	.078	.086	.095
D	.500	.506	.512	.700	.706	.712
E	.335	.340	.347	.335	.340	.347
E1	.292	.296	.300	.292	.296	.300
E2	.262	.267	.272	.262	.267	.272
N	20			28		

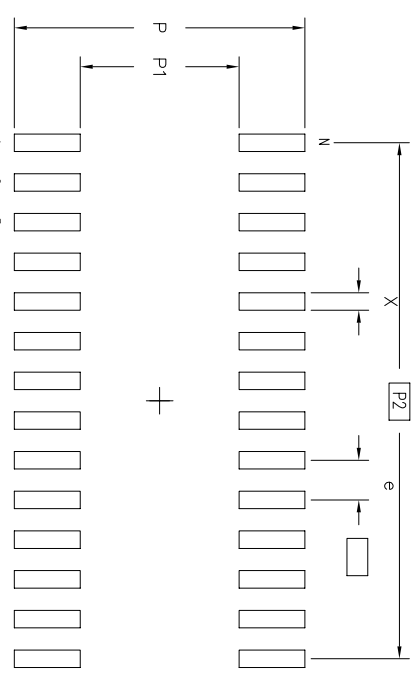

	MIN	MAX	MIN	MAX
P	.362	.370	.362	.370
P1	.196	.204	.196	.204
P2	.450 BSC	.650 BSC		
X	.018	.026	.018	.026
e	.050 BSC	.050 BSC		
N	20		28	

NOTES:

- ALL DIMENSIONING AND TOLERANCING CONFORM TO ANSI Y14.5M-1982
- DATUMS **-A-** AND **-B-** TO BE DETERMINED AT DATUM PLANE **-H-**
- DIMENSIONS D AND E1 ARE TO BE DETERMINED AT DATUM PLANE **-H-**
- DIMENSION D DOES NOT INCLUDE MOLD FLASH, PROTRUSIONS OR GATE BURRS. MOLD FLASH, PROTRUSIONS AND GATE BURRS SHALL NOT EXCEED .006 PER SIDE.
- DIMENSION E1 DO NOT INCLUDE INTERLEAD FLASH OR PROTRUSIONS. INTERLEAD FLASH OR PROTRUSIONS SHALL NOT EXCEED .006 PER SIDE
- DIMENSION E2 TO BE DETERMINED AT SEATING PLANE **-C-** CONTACT POINT
- THE CHAMFER ON THE PACKAGE BODY IS OPTIONAL. IF IT IS NOT PRESENT, A VISUAL INDEX FEATURE MUST BE LOCATED WITHIN THE ZONE INDICATED
- LEAD WIDTH DIMENSION DOES NOT INCLUDE DAMBAR PROTRUSION. ALLOWABLE DAMBAR PROTRUSION IS .004 IN EXCESS OF THE LEAD WIDTH DIMENSION AT MAXIMUM MATERIAL CONDITION
- EXACT SHAPE OF EACH CORNER IS OPTIONAL
- ALL DIMENSIONS ARE IN INCHES
- THIS OUTLINE CONFORMS TO JEDEC PUBLICATION 95 REGISTRATION MO-088, VARIATION AD & AF

TOLERANCES UNLESS SPECIFIED

DECIMAL	±	ANGULAR	±
xxx±		xxxx±	

APPROVALS: _____ DATE: _____

CHECKED: _____

SIZE: **C** DRAWING No. **PSC-4024** REV **05**

DO NOT SCALE DRAWING SHEET 2 OF 2

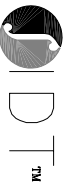

6024 SILVERCREEK VALLEY RD
SAN JOSE CA 95138
PHONE: (408) 284-8200
FAX: (408) 284-8591