

## Low-Cost 16-Pin Frequency Generator

### General Description

The **9154A** is a 0.8mm version of the industry leading 9154. Like the 9154, the **9154A** is a low-cost frequency generator designed for general purpose PC and disk drive applications. However, because the **9154A** uses 0.8mm technology and the latest phase-locked loop architecture, it offers performance advantages that enable the device to be sold into Pentium™ systems.

The 9154A guarantees a 45/55 duty cycle over all frequencies. In addition, a worst case jitter of  $\pm 250$ ps is specified at Pentium frequencies.

The CPU clock offers the unique feature of smooth, glitch-free transitions from one frequency to the next, making this the ideal device to use when slowing the CPU speed. The **9154A** makes a gradual transition between frequencies so that it obeys the Intel cycle-to-cycle timing specifications for 486 and Pentium systems.

The **9154A-42** and **9154A-43** devices offer features specifically for green PCs. The **9154A-42** and **-43** have a single pin that, when pulled low, will smoothly slow the 2XCPU clock to 8 MHz. This is ideal for dynamic DX microprocessors. The **9154A-43** not only has the slow clock feature, but also offers a glitch-free stop clock for static SX microprocessors. The STOPCLK# pin, when pulled low, enables the 2XCPU clock to go low only after completing its last full cycle. The clock continues to run internally, and will be output again on the first full cycle immediately following stop clock disable. The simultaneous 2X and 1X CPU clocks offer controlled skew to within 500ps of each other (**-42** only).

ICS has been shipping motherboard frequency generators since April 1990, and is the leader in the area of multiple output clocks on a single chip. Consult ICS for all your clock generation needs.

### Features

- Compatible with 386, 486 and Pentium CPUs
- 45/55 Duty cycle
- Runs up to 66 MHz at 3.3V
- Single pin can slow clock to 8 MHz (on **-42** and **-43**)
- Single pin can stop the CPU clock glitch-free (on **-43**)
- Very low jitter,  $\pm 250$ ps for Pentium frequencies
- 1X and 2X CPU clocks skew controlled to  $\pm 250$ ps (**-42** only)
- Smooth transitions between all CPU frequencies
- Slow frequency ramp at power-on avoids CPU lock-up
- 16-pin 150-mil skinny SOIC packages
- 0.8 $\mu$ m CMOS technology

### Applications

Computer motherboards: The **9154A** replaces crystals and oscillators, saving board space, component cost, part count and inventory costs. It produces a switchable CPU clock and up to four fixed clocks to drive floppy disk, communications, super I/O, Bus, and/or keyboard devices. The small package and 3.3V operation is perfect for handheld computers.

### Block Diagram

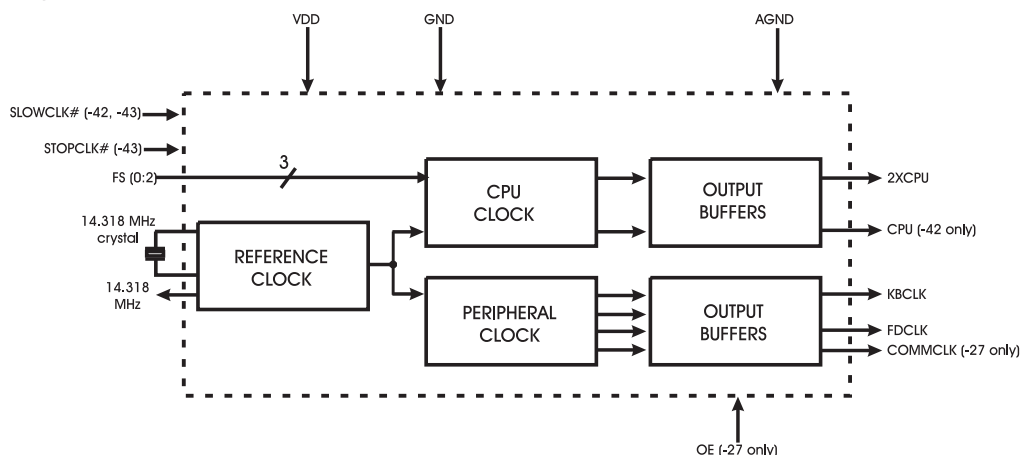

## Pin Configuration

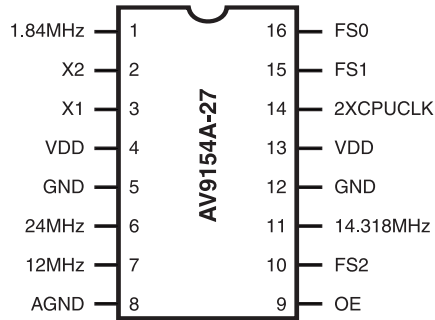

**16-SOIC  
9154A-27CS16**

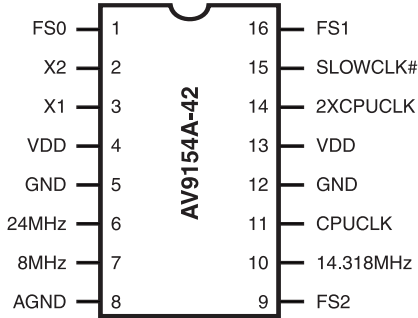

**16-SOIC  
9154A-42CS16**

Description of new pin:

SLOWCLK# forces 2XCPUCLK output to ramp smoothly to 8MHz and CPUCLK output to 4 MHz when pulled low.

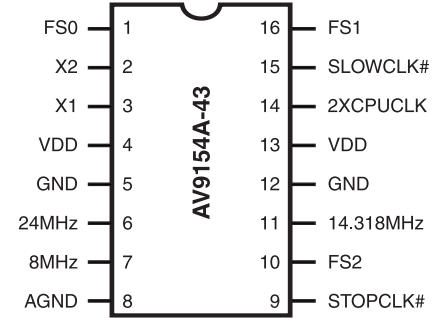

**16-SOIC  
9154A-43CS16**

Description of new pins:

SLOWCLK# forces 2XCPUCLK output to ramp smoothly to 8MHz when pulled low. STOPCLK# provides glitch-free stop of the 2XCPUCLK output when pulled low. When raised back high, the 2XCPUCLK output clock resumes full speed operation (no clock frequency ramp up since the internal VCO is not stopped).

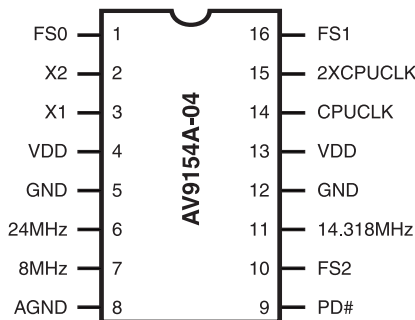

**16-SOIC  
9154A-04CS16**

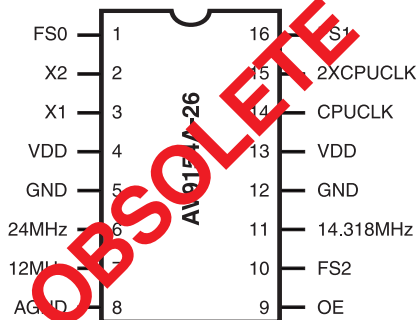

**16-SOIC  
9154A-26CS16**

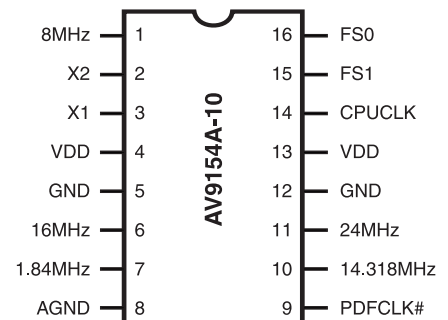

**16-SOIC  
9154A-10CS16**



## Stop Clock Feature

The 9154A-43 incorporates a unique stop clock feature compatible with static logic processors. When the stop clock pin goes low, the 2XCPUCLK will go low after the next occurring falling edge. When STOPCLK again goes high, 2XCPUCLK resumes on the next rising edge of the internal clock. This feature enables fast, glitch-free starts and stops of the 2XCPUCLK and is guaranteed that the CPU does not receive any short period clocks.

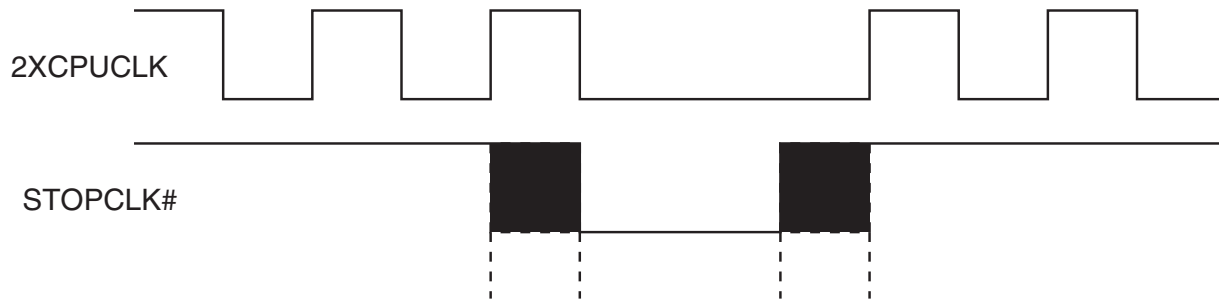



## Pin Descriptions

Frequencies based upon 14.318 MHz input)

PIN NUMBER						PIN NAME	TYPE	DESCRIPTION
-4	-10	-26	-27	-42	-43			
4	4	4	4	4	4	VDD	P	Digital power (3.3 or 5V).
13	13	13	13	13	13	VDD	P	Digital power (3.3 or 5V).
5	5	5	5	5	5	GND	P	Digital ground.
12	12	12	12	12	12	GDD	P	Digital ground.
8	8	8	8	8	8	AGND	P	Analog ground.
1	16	1	16	1	1	FS0	I	Frequency select 0 for CPU clock (has internal pull-up).*
16	15	16	15	16	16	FS1	I	Frequency select 1 for CPU clock (has internal pull-up).*
10	-	10	10	9	10	FS2	I	Frequency select 2 for CPU clock (has internal pull-up).*
-	-	9	9	-	-	OE	I	Tristates outputs when low (has internal pull-up).*
-	-	-	-	15	15	SLOWCLK#	I	Slows 2XCPU clock to 8 MHz (active low) (has internal pull-up).
-	-	-	-	-	9	STOPCLK#	I	Stops 2XCPU clock glitch-free (active low) (has internal pull-up).
3	3	3	3	3	3	X1	I	Crystal In.
2	2	2	2	2	2	X2	O	Crystal Out.
11	10	11	11	10	11	14.318 MHz	O	14.318 MHz reference clock output.
-	7	-	1	-	-	1.84 MHz	O	1.84 MHz (comm) clock output.
6	11	6	6	6	6	24 MHz	O	24 MHz (floppy disk) clock output.
-	6	-	-	-	-	16 MHz	O	16 MHz clock output.
-	-	7	7	-	-	12 MHz	O	12 MHz keyboard clock output.
7	1	-	-	7	7	8 MHz	O	8 MHz keyboard clock output.
14	14	14	-	11	-	CPUCLK	O	CPU clock output.
15	-	15	14	14	14	2XCPUCLK	O	2X CPU clock output.
9	-	-	-	-	-	PD#	I	Power-Down All (active low) (has internal pull-up).
-	9	-	-	-	-	PDFCLK#	I	Power-Down Fixed Clock (1.84, 8, 16, 24) (active low).*

Note:

Internal Pull-up Resistors.

\* -04 and -10 have no pull-ups or frequency select pins

\*\* -10 has no pull-up or Pin 9 PDFCLK



Clock Tables (using 14.318 MHz input, all frequencies in MHz)						
FS2	FS1	FS0	-27 2XCPUCLK	-42		-43 2XCPUCLK
				2XCPUCLK	CPUCLK	^
0	0	0	75*	16	8	16
0	0	1	32	40	20	40
0	1	0	60	33.33	16.67	33.33
0	1	1	40	25	12.5	25
1	0	0	50	60	30	60
1	0	1	66.66	20	10	20
1	1	0	80*	66.66	33.33	66.66
1	1	1	52	50	25	50

Actual Frequencies (using 14.318 MHz input, all frequencies in MHz)						
FS2	FS1	FS0	-27 2XCPUCLK	-42		-43
				2XCPUCLK	CPUCLK	2XCPUCLK
0	0	0	75.17*	16.00	8.00	16.00
0	0	1	31.94	40.09	20.05	40.09
0	1	0	60.14	33.41	16.71	33.41
0	1	1	40.09	25.06	12.55	25.06
1	0	0	50.11	60.14	30.07	60.14
1	0	1	66.48	20.05	10.03	20.05
1	1	0	80.18*	66.48	33.24	66.48
1	1	1	51.90	50.11	25.06	50.11

Fixed Clock Output Actual Frequencies (using 14.318 MHz input, all frequencies in MHz)
14.318
1.84
24.0
12.0
8.0

Clock Tables in MHz for -04 and -10 (using 14.318 MHz input, all frequencies in MHz)			
FS(3:0)	-04		-10
	2XCPU	CPU	CPUCLK
0	100*	50*	PDCPU
1	80*	40*	40
2	66.6	33.3	50
3	50	25	66.6
4	40	20	-
5	32	16	-
6	24	12	-
7	16	8	-
-			

Clock Table for 9154A-26 (using 14.318 MHz input, all frequencies in MHz)		
FS(2:0)	2XCPU (MHz)	CPUCLK (MHz)
0	100.23*	50.11
1	80.18*	40.09
2	66.48*	33.24
3	50.11	25.06
4	40.09	20.05
5	32.22	16.11
6	24.23	12.12
7	15.75	7.88

## Absolute Maximum Ratings

V <sub>DD</sub> referenced to GND .....	7.0 V
Voltage on I/O pins referenced to GND .....	GND - 0.5 V to VDD + 0.5 V
Operating Temperature under bias .....	0 to +70 °C
Power Dissipation .....	0.5 W
Storage Temperature .....	-40 to +150 °C

Stresses above those listed under *Absolute Maximum Ratings* may cause permanent damage to the device. These ratings are stress specifications only and functional operation of the device at these or any other conditions above those listed in the operational sections of the specifications is not implied. Exposure to absolute maximum rating conditions for extended periods may affect product reliability.

## Electrical Characteristics at 3.3 V

V<sub>DD</sub> = 3.3 V ± 10%, T<sub>A</sub> = 0 - 70 °C unless otherwise stated

DC Characteristics						
PARAMETER	SYMBOL	TEST CONDITIONS	MIN	TYP	MAX	UNITS
Input Low Voltage	V <sub>IL</sub>		-	-	0.2 V <sub>DD</sub>	V
Input High Voltage	V <sub>IH</sub>		0.7 V	-	-	V
Input Low Current	I <sub>IL</sub>	V <sub>IN</sub> = 0V (pull-up pin)	-	2.5	7	A
Input High Current	I <sub>IH</sub>	V <sub>IN</sub> = V <sub>DD</sub>	-5	-	5	A
Output Low Voltage	V <sub>OL</sub>	I <sub>OL</sub> = 6mA	-	0.05 V <sub>DD</sub>	0.1 V <sub>DD</sub>	V
Output High Voltage <sup>1</sup>	V <sub>OH</sub>	I <sub>OH</sub> = -4mA	0.85 V <sub>DD</sub>	0.94 V <sub>DD</sub>	-	V
Output Low Current <sup>1</sup>	I <sub>OL</sub>	V <sub>OL</sub> = 0.2V <sub>DD</sub>	15	24	-	mA
Output High Current <sup>1</sup>	I <sub>OH</sub>	V <sub>OH</sub> = 0.7V <sub>DD</sub>	-	-13	-8	mA
Supply Current	I <sub>DD</sub>	unloaded, 60 MHz	-	16	34	mA
Output Frequency Change over Supply and Temperature <sup>1</sup>	FD	With respect to typical frequency	-	0.002	0.01	%
Short circuit current <sup>1</sup>	I <sub>SC</sub>	each output clock	20	30	-	mA
Input Capacitance <sup>1</sup>	C <sub>I</sub>	except X1, X2	-	-	10	pF
Load Capacitance <sup>1</sup>	C <sub>L</sub>	pins X1, X2	-	20	-	pF
Pull-up Resistor <sup>1</sup>	R <sub>pu</sub>	at V <sub>DD</sub> - 0.5V	-	620	900	k ohm

### Notes:

1. Parameter is guaranteed by design and characterization.

## Electrical Characteristics at 3.3 V

$V_{DD} = 3.3 \text{ V} \pm 10\%$ ,  $T_A = 0 - 70 \text{ }^\circ\text{C}$  unless otherwise stated

AC Characteristics						
PARAMETER	SYMBOL	TEST CONDITIONS	MIN	TYP	MAX	UNITS
Input Clock Rise Time <sup>1</sup>	t <sub>icr</sub>		-	-	20	ns
Input Clock Fall Time <sup>1</sup>	t <sub>icf</sub>		-	-	20	ns
Rise time, 20% to 80% $V_{DD}$ <sup>1</sup>	t <sub>r</sub>	15pF load	-	2.2	3.5	ns
Fall time, 80% to 20% $V_{DD}$ <sup>1</sup>	t <sub>f</sub>	15pF load	-	1.2	2.5	ns
Duty cycle at 50% $V_{DD}$ <sup>1</sup>	d <sub>t</sub>	15pF load	40/60	48/52	60/40	%
Duty cycle, reference clocks <sup>1</sup>	d <sub>t</sub>	15pF load	50/65	43/57	65/50	%
Jitter, one sigma, 20-66 MHz clocks <sup>1</sup>	t <sub>j1s</sub>	10,000 cycles	-	100	200	ps
Jitter, one sigma, clocks below 20 MHz <sup>1</sup>	t <sub>j1s</sub>	10,000 cycles	-	1.0	2.0	%
Jitter, absolute, 20-66 MHz clocks <sup>1</sup>	t <sub>jab</sub>	10,000 cycles	-350	-	350	ps
Jitter, absolute, clocks below 20 MHz <sup>1</sup>	t <sub>jab</sub>	10,000 cycles	-	1.5	4.0	%
Input Frequency <sup>1</sup>	f <sub>in</sub>		2	14.318	32	MHz
Maximum Output Frequency <sup>1</sup>	f <sub>out</sub>		70	-	-	MHz
Clock skew between CPU and 2XCPU outputs <sup>1</sup>	T <sub>sk</sub>	9154A-42	-	220	500	ps
Power-up Time <sup>1</sup>	t <sub>tPO</sub>	off to 50 MHz	-	6	12	ms
Frequency Transition Time <sup>1</sup>	t <sub>ft</sub>	from 8 to 50 MHz	-	4.5	10	ms

**Notes:**

1. Parameter is guaranteed by design and characterization. Not subject to production testing.

## Electrical Characteristics at 5.0 V

$V_{DD} = +5 \pm 10\% V$ ,  $T_A = 0 - 70^\circ C$  unless otherwise stated

DC Characteristics						
PARAMETER	SYMBOL	TEST CONDITIONS	MIN	TYP	MAX	UNITS
Input Low Voltage	$V_{IL}$	$V_{DD}=5 V$	-	-	0.8	V
Input High Voltage	$V_{IH}$	$V_{DD}=5 V$	2.0	-	-	V
Input Low Current	$I_{IL}$	$V_{IN}=0 V$ (pull-up pin)	-	6	15	A
Input High Current	$I_{IH}$	$V_{IN} = V_{DD}$	-5	-	5	A
Output Low Voltage	$V_{OL}$	$I_{OL} = 10 mA$	-	0.15	0.4	V
Output High Voltage <sup>1</sup>	$V_{OH}$	$I_{OH} = -30 mA$	2.4	3.7	-	V
Output Low Current <sup>1</sup>	$I_{OL}$	$V_{OL} = 0.8 V$	25	45	-	mA
Output High Current <sup>1</sup>	$I_{OH}$	$V_{OH} = 2.4 V$	-	-53	-35	mA
Supply Current	$I_{DD}$	unloaded, 66 MHz	-	25	50	mA
Output Frequency Change over Supply and Temperature <sup>1</sup>	$F_D$	with respect to typical frequency	-	0.002	0.01	%
Short circuit current <sup>1</sup>	$I_{SC}$	each output clock	25	40	-	mA
Input Capacitance <sup>1</sup>	$C_I$	except X1, X2	-	-	10	pF
Load Capacitance <sup>1</sup>	$C_L$	pins X1, X2	-	20	-	pF
Pull-up Resistor <sup>1</sup>	$R_{pu}$	A + $V_{DD} - 1 V$	-	400	700	k ohm

**Notes:**

1. Parameter is guaranteed by design and characterization. Not subject to production testing.



## Electrical Characteristics at 5.0 V

$V_{DD} = +5 \pm 10\% V$ ,  $T_A = 0 - 70^\circ C$  unless otherwise stated

AC Characteristics						
PARAMETER	SYMBOL	TEST CONDITIONS	MIN	TYP	MAX	UNITS
Input Clock Rise Time <sup>1</sup>	t <sub>Cr</sub>		-	-	20	ns
Input Clock Fall Time <sup>1</sup>	t <sub>Cf</sub>		-	-	20	ns
Output Rise time, 0.8 to 2.0V <sup>1</sup>	t <sub>r</sub>	15pF load	-	1.5	2	ns
Rise time, 20% to 80% V <sup>1</sup>	t <sub>r</sub>	15pF load	-	2.0	3	ns
Output Fall time, 2.0 to 0.8V <sup>1</sup>	t <sub>f</sub>	15pF load	-	0.5	1.5	ns
Fall time, 80% to 20% V <sup>1</sup>	t <sub>f</sub>	15pF load	-	2.0	3.0	ns
Duty cycle at 1.4V <sup>1</sup>	dt	15pF load, V <sub>DD</sub> = 5V±5%	45/55	48/52	55/45	%
Duty cycle, reference clocks <sup>1</sup>	dt	15 pF load	40/65	43/57	65/40	%
Jitter, one sigma, 20 MHz- 80 MHz clocks <sup>1</sup>	t <sub>j1s</sub>	10,000 cycles	-	70	140	ps
Jitter, one sigma, clocks below 20 MHz <sup>1</sup>	t <sub>jls</sub>	10,000 cycles	-	0.8	2.0	%
Jitter, absolute, 20 MHz- 80 MHz clocks <sup>1</sup>	t <sub>jab</sub>	10,000 cycles	-250	-	250	ps
Jitter, absolute, clocks below 20 MHz <sup>1</sup>	t <sub>jab</sub>	10,000 cycles	-	1.0	3.0	%
Input Frequency	f <sub>in</sub>		2	14.318	32	MHz
Maximum Output Frequency <sup>1</sup>	f <sub>out</sub>		140	-	-	MHz
Clock skew between CPU and 2XCPU outputs <sup>1</sup>	T <sub>sk</sub>	9154A-42	-	140	400	ps
Power-up Time <sup>1</sup>	t <sub>iPO</sub>	to 80 MHz	-	8	15	ms
Frequency Transition Time <sup>1</sup>	t <sub>ft</sub>	from 8 to 66.66 MHz	-	6.5	12	ms

### Notes:

1. Parameter is guaranteed by design and characterization. Not subject to production testing.

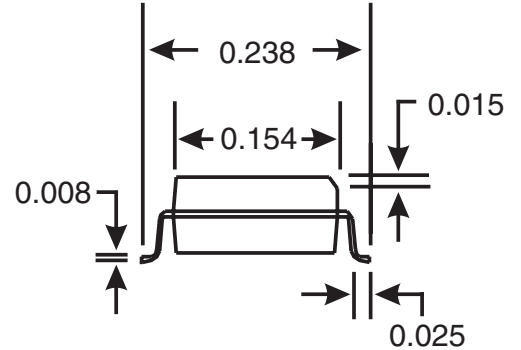
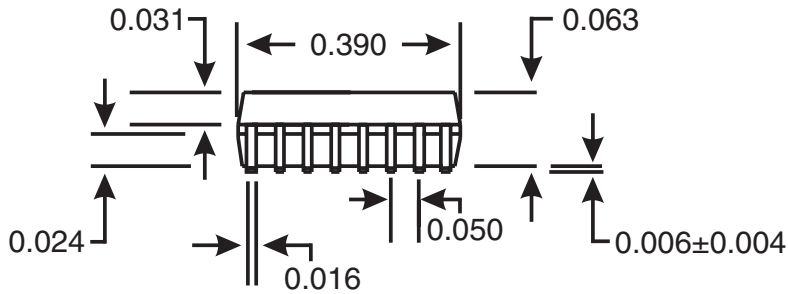

### 16-Pin SOIC Package

## Ordering Information

9154A-04CS16	9154A-27CS16	9154A-43CS16
9154A-10CS16	9154A-42CS16	

Example:

**9154A - PPC S 16 LF**

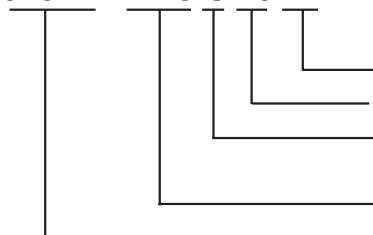

Lead Free, RoHS Compliant (Optional)

Lead Count

Package Type

S = SOIC

Pattern Number (2 digit number for parts with ROM-code patterns)

Device Type



---

---

### Revision History

Rev.	Issue Date	Description	Page #
C	4/6/2006	Added LF Ordering Information	10
D	1/24/2008	Removed DIP Ordering Information.	-
E	3/18/2008	Removed reference to "AV".	-