

Description

The IDT XA devices are ultra-precision crystal oscillators with 750 to 890fs typical phase jitter over 12kHz to 20MHz bandwidth. Available in a wide frequency range from 0.750MHz to 1350MHz, the XA series crystal oscillators utilize a family of proprietary ASICs, with a key focus on noise reduction technologies.

The 3rd order Delta Sigma Modulator reduces noise to the levels that are comparable to traditional Bulk Quartz and SAW oscillators. With short lead-time, low cost, low noise, wide frequency range, excellent ambient performance, the XA devices are an excellent choice over the conventional technologies. The XA devices have stabilities as tight as ± 25 ppm with extremely quick delivery for both standard and custom frequencies.

Pin Assignments

NOTE: To minimize power supply line noise, a 0.01 μ F bypass capacitor should be placed between V_{DD} (Pin 6) and GND (Pin 3) on 6-pin devices, or V_{DD} (Pin 4) and GND (Pin 2) on 4-pin devices.

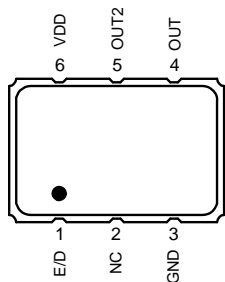

Table 1. 6-pin Package

Pin #	Pin Name	Description
1	E/D	Enable/Disable [a,b]
2	NC	No connect
3	GND	Connect to ground
4	OUT	Output
5	OUT2	Complementary output
6	V_{DD}	Supply voltage

Features

- Conforms to AEC-Q200
- Frequency range: 0.750MHz to 1350MHz
- Output types: LVDS, LVPECL, LVCMOS
- Frequency stability: ± 25 , ± 50 , or ± 100 ppm
- Supply voltage: 2.5V or 3.3V
- Phase jitter (12kHz to 20MHz): 750fs to 890fs typical
- Package options:
 - 3.2 × 2.5 × 1.0 mm
 - 5.0 × 3.2 × 1.2 mm
- Operating temperature: -40°C to +85°C (Grade 3)
 - Frequency stability options: ± 25 , ± 50 , or ± 100 ppm
- Operating temperature: -40°C to +105°C (Grade 2)
 - Frequency stability options: ± 50 or ± 100 ppm

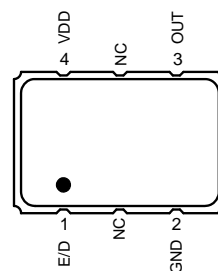

Table 2. 4-pin Package

Pin #	Pin Name	Description
1	E/D	Enable/Disable [a,b]
2	GND	Connect to ground
3	OUT	Output
4	V_{DD}	Supply voltage

[a] Pulled high internally.
[b] Low = output disabled.

See [Ordering Information](#) for more details.

Contents

Description	1
Features	1
Pin Assignments	1
Absolute Maximum Ratings	3
ESD Compliance	3
Mechanical Testing	3
Solder Reflow Profile	3
DC Electrical Characteristics	4
AC Electrical Characteristics	6
Output Waveforms – LVDS	9
Output Waveforms – LVPECL	9
Output Waveforms – LVCMOS	10
Package Outline Drawings	10
Ordering Information	11
Revision History	12

Absolute Maximum Ratings

Stresses above the ratings listed below can cause permanent damage to the device. These ratings, which are standard values for IDT commercially rated parts, are stress ratings only. Functional operation of the device at these or any other conditions above those indicated in the operational sections of the specifications is not implied. Exposure to absolute maximum rating conditions for extended periods can affect product reliability. Electrical parameters are guaranteed only over the recommended operating temperature range.

Table 3. Absolute Maximum Ratings

Item	Rating			
V_{DD}	-0.5 to +5.0V			
E/D	-0.5V to $V_{DD} + 0.5V$			
OUT	-0.5V to $V_{DD} + 0.5V$			
Storage Temperature	-55°C to 125°C			
Maximum Junction Temperature	125°C			
Core Current	65mA maximum			
Theta J_A	JS6	89.6 °C/W	JX6	94.7 °C/W
Theta J_B	5.0 × 3.2 × 1.2 mm	54.3 °C/W	3.2 × 2.5 × 1.0 mm	66.8 °C/W

ESD Compliance

Human Body Model (HBM)	1000V
Machine Model (MM)	150V

Mechanical Testing

Parameter	Test Method
Mechanical Shock	Drop from 75cm to hardwood surface—3 times.
Mechanical Vibration	10–55Hz, 1.5mm amplitude, 1 minute sweep; 2 hours each in 3 directions (X, Y, Z).
High Temperature Burn-in	Under power at 125°C for 2000 hours.
Hermetic Seal	He pressure: 4 ±1kgf/cm ² 2 hour soak.

Solder Reflow Profile

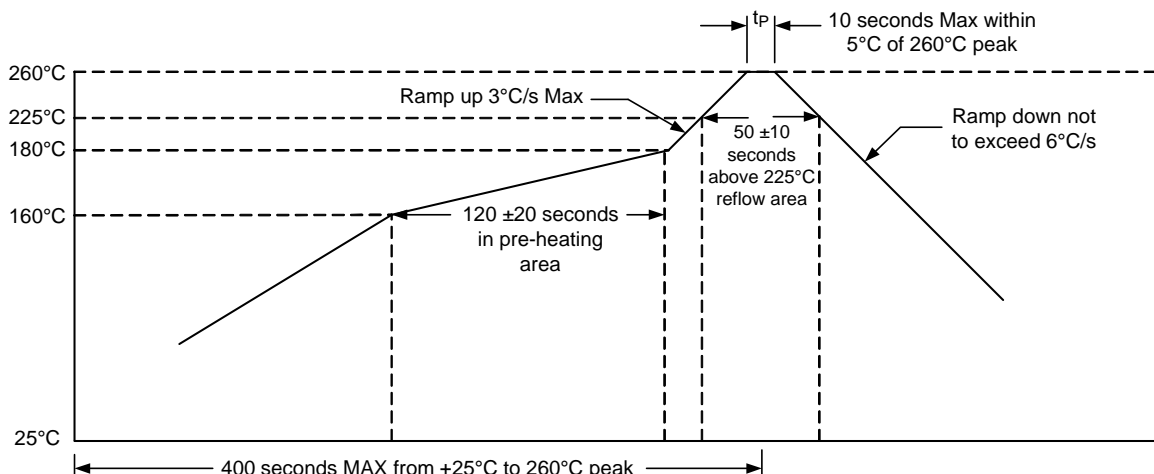

DC Electrical Characteristics

Table 4. 3.3V IDD DC Electrical Characteristics

 $V_{DD} = 3.3V \pm 5\%$, $T_A = -40^\circ C$ to $+85^\circ C$, $-40^\circ C$ to $+105^\circ C$.

Symbol	Parameter	Output Type	Conditions	Minimum	Typical	Maximum	Units
I_{DD}	Power Supply Current	LVDS	—	—	—	100	mA
		LVPECL	—	—	—	120	
		LVCMOS	0.75MHz to 20MHz.	—	—	32	
			20+MHz to 50MHz.	—	—	35	
			50+MHz to 130MHz.	—	—	47	
			130+MHz to 200MHz.	—	—	55	
200+MHz to 250MHz.	—	—	60				

Table 5. 2.5V IDD DC Electrical Characteristics

 $V_{DD} = 2.5V \pm 5\%$, $T_A = -40^\circ C$ to $+85^\circ C$, $-40^\circ C$ to $+105^\circ C$.

Symbol	Parameter	Output Type	Conditions	Minimum	Typical	Maximum	Units
I_{DD}	Power Supply Current	LVDS	0.75MHz to 20MHz.	—	—	26	mA
			20+MHz to 220MHz.	—	—	34	
			220+MHz to 630MHz.	—	—	44	
			630+MHz to 1000MHz.	—	—	65	
		LVPECL	0.75MHz to 20MHz.	—	—	33	
			20+MHz to 220MHz.	—	—	41	
			220+MHz to 630MHz.	—	—	63	
			630+MHz to 1000MHz.	—	—	72	
		LVCMOS	0.75MHz to 20MHz.	—	—	22	
			20+MHz to 50MHz.	—	—	25	
			50+MHz to 100MHz.	—	—	29	
			100+MHz to 130MHz.	—	—	32	
			130+MHz to 160MHz.	—	—	35	
			160+MHz to 180MHz.	—	—	37	

Table 6. LVDS DC Electrical Characteristics

 $V_{DD} = 3.3V, 2.5V \pm 5\%$, $T_A = -40^\circ C$ to $+85^\circ C, -40^\circ C$ to $+105^\circ C$. Below are guaranteed for listed standard frequencies.

Symbol	Parameter	Conditions	Minimum	Typical	Maximum	Units
V_{OD}	Differential Output Voltage	$V_{DD} = 3.3V \pm 5\%$.	—	—	0.6	V
		$V_{DD} = 2.5V \pm 5\%$.	—	—	0.4	
V_{OS}	Output Offset Voltage	$V_{DD} = 3.3V \pm 5\%$.	—	—	1.3	
		$V_{DD} = 2.5V \pm 5\%$.	—	—	1.25	
V_{IH}	Enable/Disable Input High Voltage (Output enabled)	—	$70\% V_{DD}$	—	—	
V_{IL}	Enable/Disable Input Low Voltage (Output disabled)	—	—	—	$30\% V_{DD}$	

Table 7. LVPECL DC Electrical Characteristics

 $V_{DD} = 3.3V, 2.5V \pm 5\%$, $T_A = -40^\circ C$ to $+85^\circ C, -40^\circ C$ to $+105^\circ C$. Below are guaranteed for listed standard frequencies.

Symbol	Parameter	Conditions	Minimum	Typical	Maximum	Units
V_{OD}	Differential Output Voltage	$V_{DD} = 3.3V \pm 5\%$.	2.055	—	2.405	V
		$V_{DD} = 2.5V \pm 5\%$.	—	1.4	—	
V_{OS}	Output Offset Voltage	$V_{DD} = 3.3V \pm 5\%$.	1.305	—	1.65	
		$V_{DD} = 2.5V \pm 5\%$.	—	0.68	—	
V_{IH}	Enable/Disable Input High Voltage (Output enabled)	—	$70\% V_{DD}$	—	—	
V_{IL}	Enable/Disable Input Low Voltage (Output disabled)	—	—	—	$30\% V_{DD}$	

Table 8. LVCMOS DC Electrical Characteristics

 $V_{DD} = 3.3V, 2.5V \pm 5\%$, $T_A = -40^\circ C$ to $+85^\circ C, -40^\circ C$ to $+105^\circ C$. Below are guaranteed for listed standard frequencies.

Symbol	Parameter	Conditions		Minimum	Typical	Maximum	Units
V_{OH}	Output High Voltage	$V_{DD} = 3.3V \pm 5\%$.	0.75MHz to 150MHz.	$90\% V_{DD}$	—	—	V
			150+MHz to 250MHz.	$80\% V_{DD}$	—	—	
		$V_{DD} = 2.5V \pm 5\%$.	0.75MHz to 160MHz.	$90\% V_{DD}$	—	—	
			160+MHz to 180MHz.	$80\% V_{DD}$	—	—	
V_{OL}	Output Low Voltage	$V_{DD} = 3.3V \pm 5\%$.	0.75MHz to 150MHz.	—	—	$10\% V_{DD}$	
			150+MHz to 250MHz.	—	—	$20\% V_{DD}$	
		$V_{DD} = 2.5V \pm 5\%$.	0.75MHz to 160MHz.	—	—	$10\% V_{DD}$	
			160+MHz to 180MHz.	—	—	$20\% V_{DD}$	
V_{IH}	Enable/Disable Input High Voltage (Output enabled)	—	—	$70\% V_{DD}$	—	—	
V_{IL}	Enable/Disable Input Low Voltage (Output disabled)	—	—	—	—	$30\% V_{DD}$	

AC Electrical Characteristics

Table 9. 3.3V AC Electrical Characteristics

 $V_{DD} = 3.3V \pm 5\%$, $T_A = -40^\circ C$ to $+85^\circ C$, $-40^\circ C$ to $+105^\circ C$.

Symbol	Parameter	Test Condition		Minimum	Typical	Maximum	Units
F	Output Frequency Range	LVDS.		0.75	—	1350	MHz
		LVPECL.		0.75	—	1350	
		LVCMOS.		0.75	—	250	
	Frequency Stability	Temperature = $-40^\circ C$ to $+85^\circ C$.		± 25	—	± 100	ppm
		Temperature = $-40^\circ C$ to $+105^\circ C$.		± 50	—	± 100	ppm
	Aging (1st year)	$T_A = 25^\circ C$.		—	—	± 3	ppm
	Aging (10 years)	$T_A = 25^\circ C$.		—	—	± 10	ppm
	Output Load	LVDS.	Differential.	—	100	—	Ω
		LVPECL.	$V_{DD} - 2.0V$.	—	50	—	
		LVCMOS.	To GND.	—	15	—	pF
T_{ST}	Start-up Time	Output valid time after V_{DD} meets minimum specified level.		—	—	10	ms
t_R	Output Rise Time	LVDS.	20% to 80% V_{pp} .	—	—	400	ps
		LVPECL.		—	—	400	
		LVCMOS.	10% to 90% V_{DD} .	—	—	3	ns
t_F	Output Fall Time	LVDS.	80% to 20% V_{pp} .	—	—	400	ps
		LVPECL.		—	—	400	
		LVCMOS.	90% to 10% V_{DD} .	—	—	3	ns
O_{DC}	Output Clock Duty Cycle	LVDS.		45	—	55	%
		LVPECL.		45	—	55	
		LVCMOS.	$F_{OUT} \leq 62.5MHz$.	45	—	55	
			$F_{OUT} \geq 62.5MHz$.	40	—	60	
T_{OE}	Output Enable/ Disable Time	—		—	—	100	ns
J_{PER}	Period Jitter, RMS	LVDS.		—	3	—	ps
		LVPECL.		—	5.8	—	
		LVCMOS.	$F_{OUT} = 125MHz$.	—	5	—	
R_J	Random Jitter	LVDS.		—	1.3	—	ps
		LVPECL.		—	1.29	—	
		LVCMOS.	$F_{OUT} = 125MHz$.	—	0.6	—	
D_J	Deterministic Jitter	LVDS.		—	5.8	—	ps
		LVPECL.		—	9.3	—	
		LVCMOS.	$F_{OUT} = 125MHz$.	—	10	—	

Table 9. 3.3V AC Electrical Characteristics (Cont.)

 $V_{DD} = 3.3V \pm 5\%$, $T_A = -40^\circ C$ to $+85^\circ C$, $-40^\circ C$ to $+105^\circ C$.

Symbol	Parameter	Test Condition	Minimum	Typical	Maximum	Units
T_J	Total Jitter	LVDS.	—	23.6	—	ps
		LVPECL.	—	27.7	—	
		LVC MOS.	$F_{OUT} = 125MHz.$	—	19	
f_{JITTER}	Phase Jitter (12kHz–20MHz)	LVDS.	—	890	—	fs
		LVPECL.	—	860	—	
		LVC MOS.	$F_{OUT} = 125MHz.$	—	750	

Table 10. 2.5V AC Electrical Characteristics

 $V_{DD} = 2.5V \pm 5\%$, $T_A = -40^\circ C$ to $+85^\circ C$, $-40^\circ C$ to $+105^\circ C$.

Symbol	Parameter	Test Condition	Minimum	Typical	Maximum	Units	
F	Output Frequency Range	LVDS.	0.75	—	1000	MHz	
		LVPECL.	0.75	—	1000		
		LVC MOS.	0.75	—	180		
	Frequency Stability	Temperature = $-40^\circ C$ to $+85^\circ C$.	± 25	—	± 100	ppm	
		Temperature = $-40^\circ C$ to $+105^\circ C$.	± 50	—	± 100	ppm	
	Aging (1st year)	$T_A = 25^\circ C$.	—	—	± 3	ppm	
	Aging (10 years)	$T_A = 25^\circ C$.	—	—	± 10	ppm	
	Output Load	LVDS.	Differential.	—	100	Ω	
		LVPECL.	$V_{DD} - 2.0V$.	—	50		
		LVC MOS.	To GND.	—	15	μF	
T_{ST}	Start-up Time	Output valid time after V_{DD} meets minimum specified level.	—	—	10	ms	
t_R	Output Rise Time	LVDS.	20% to 80% V_{pp} .	—	—	400	ps
		LVPECL.		—	—	400	
		LVC MOS.	10% to 90% V_{DD} .	—	—	3.5	ns
t_F	Output Fall Time	LVDS.	80% to 20% V_{pp} .	—	—	400	ps
		LVPECL.		—	—	400	
		LVC MOS.	90% to 10% V_{DD} .	—	—	3	ns
O_{DC}	Output Clock Duty Cycle	LVDS.	45	—	55	%	
		LVPECL.	45	—	55		
		LVC MOS.	45	—	55		
T_{OE}	Output Enable/ Disable Time	—	—	—	100	ns	

Table 10. 2.5V AC Electrical Characteristics (Cont.)

 $V_{DD} = 2.5V \pm 5\%$, $T_A = -40^\circ C$ to $+85^\circ C$, $-40^\circ C$ to $+105^\circ C$.

Symbol	Parameter	Test Condition	Minimum	Typical	Maximum	Units
J_{PER}	Period Jitter, RMS	LVDS.	—	4	—	ps
		LVPECL.	—	5.12	—	
		LVC MOS.	$F_{OUT} = 125MHz.$	—	3.3	
R_J	Random Jitter	LVDS.	—	1.4	—	ps
		LVPECL.	—	1.36	—	
		LVC MOS.	$F_{OUT} = 125MHz.$	—	1.3	
D_J	Deterministic Jitter	LVDS.	—	9.2	—	ps
		LVPECL.	—	10	—	
		LVC MOS.	$F_{OUT} = 125MHz.$	—	6.7	
T_J	Total Jitter	LVDS.	—	29.2	—	ps
		LVPECL.	—	29.3	—	
		LVC MOS.	$F_{OUT} = 125MHz.$	—	25.6	
f_{JITTER}	Phase Jitter (12kHz–20MHz)	LVDS.	—	1040	—	fs
		LVPECL.	—	1200	—	
		LVC MOS.	$F_{OUT} = 125MHz.$	—	850	

Notes for all AC Electrical Characteristics tables:

¹ All jitter values provided at 156.25MHz, unless noted otherwise.

Output Waveforms – LVDS

Output Levels/Rise Time/Fall Time Measurements

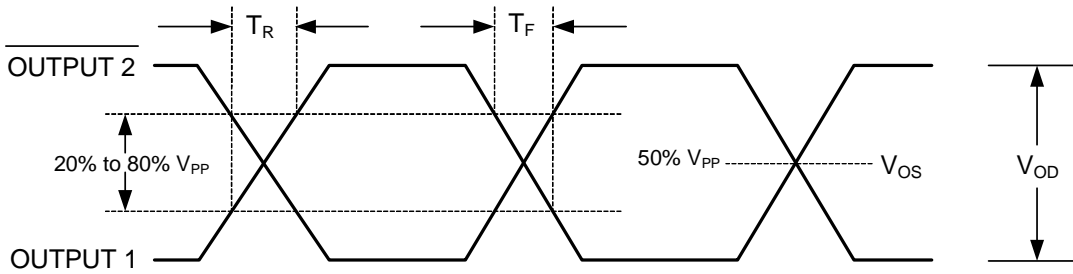

Oscillator Symmetry

Ideally, Symmetry should be 50/50 for $\frac{1}{2}$ period – Other expressions are 45/55 or 55/45

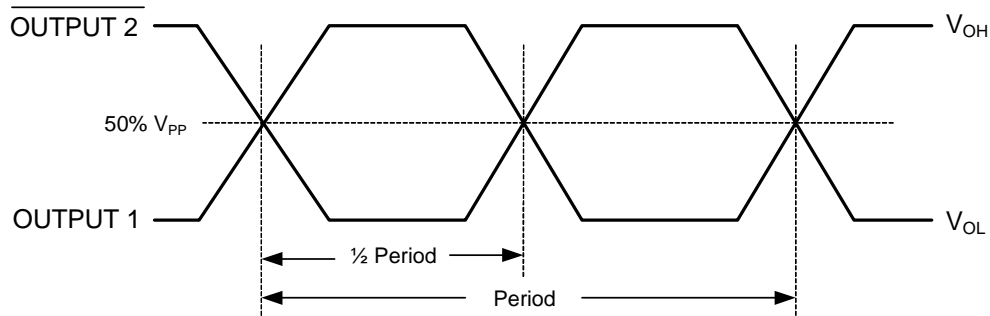

Output Waveforms – LVPECL

Rise Time/Fall Time Measurements

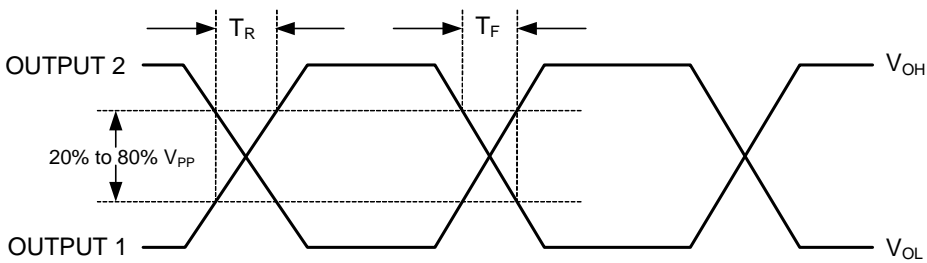

Oscillator Symmetry

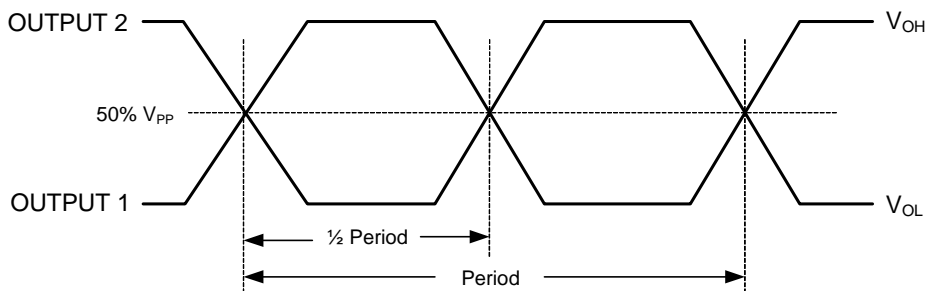

Output Waveforms – LVCMOS

Rise Time / Fall Time Measurements

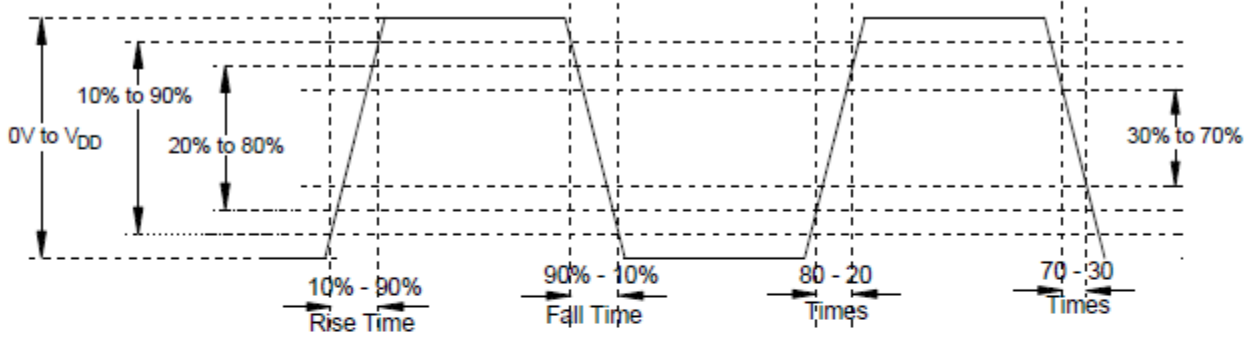

Oscillator Symmetry

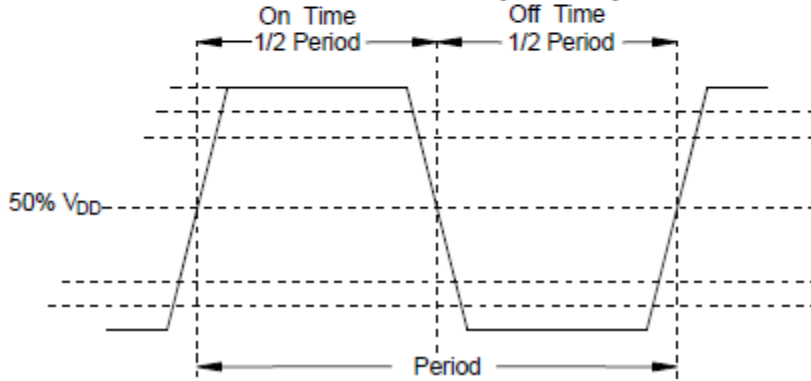

Package Outline Drawings

The package outline drawings are located at the end of this document. The package information is the most current data available.

Ordering Information

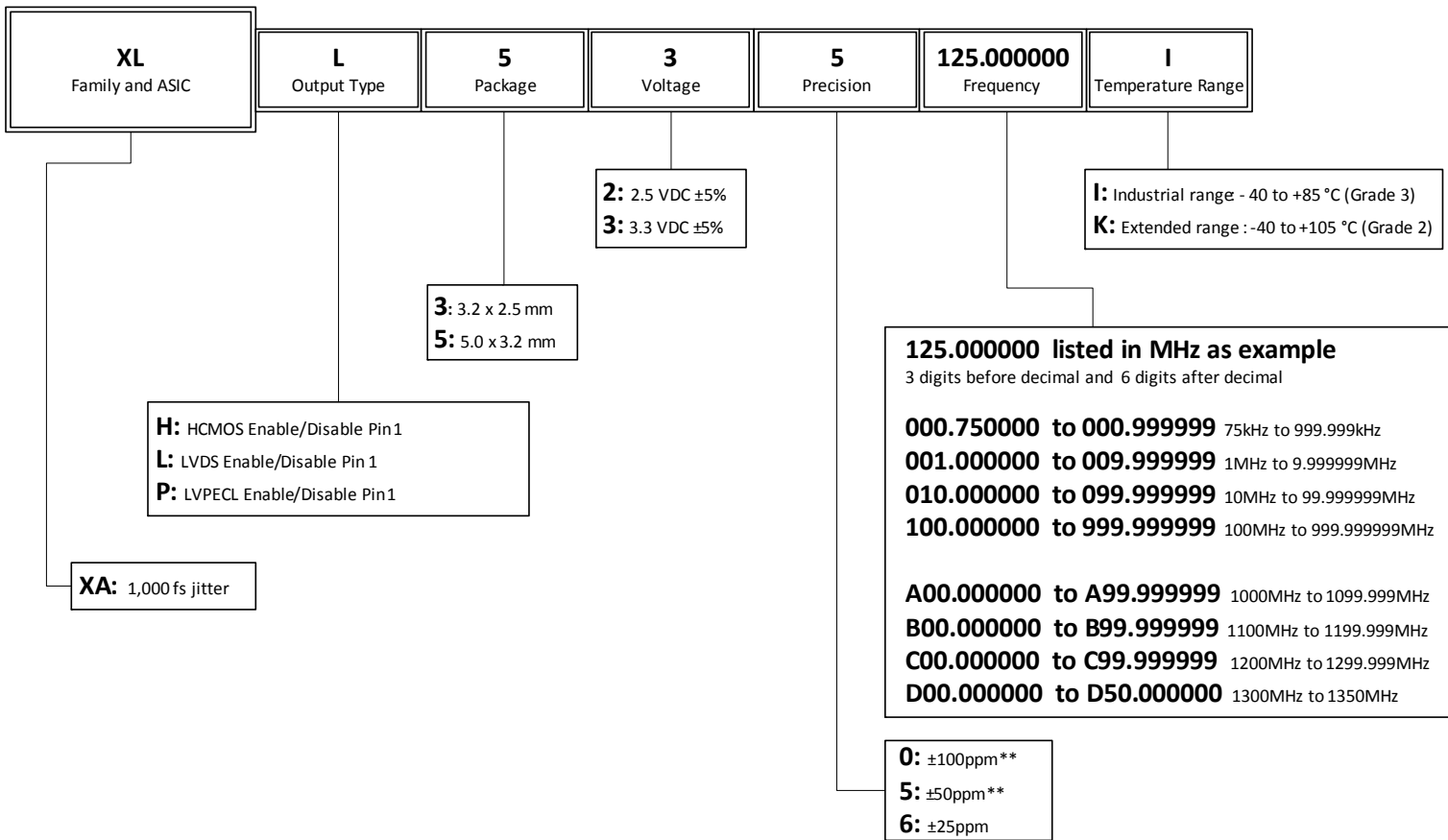

** ±100ppm and ±50ppm for K (-40°C to +105°C) only.

Revision History

Revision Date	Description of Change
May 24, 2018	Updated LVCMOS Output Clock Duty Cycle, FOOUT test condition.
April 27, 2018	Initial release.



Corporate Headquarters
 6024 Silver Creek Valley Road
 San Jose, CA 95138 USA
www.IDT.com

Sales
 1-800-345-7015 or 408-284-8200
 Fax: 408-284-2775
www.IDT.com/go/sales

Tech Support
www.IDT.com/go/support

DISCLAIMER Integrated Device Technology, Inc. (IDT) and its affiliated companies (herein referred to as "IDT") reserve the right to modify the products and/or specifications described herein at any time, without notice, at IDT's sole discretion. Performance specifications and operating parameters of the described products are determined in an independent state and are not guaranteed to perform the same way when installed in customer products. The information contained herein is provided without representation or warranty of any kind, whether express or implied, including, but not limited to, the suitability of IDT's products for any particular purpose, an implied warranty of merchantability, or non-infringement of the intellectual property rights of others. This document is presented only as a guide and does not convey any license under intellectual property rights of IDT or any third parties.

IDT's products are not intended for use in applications involving extreme environmental conditions or in life support systems or similar devices where the failure or malfunction of an IDT product can be reasonably expected to significantly affect the health or safety of users. Anyone using an IDT product in such a manner does so at their own risk, absent an express, written agreement by IDT.

Integrated Device Technology, IDT and the IDT logo are trademarks or registered trademarks of IDT and its subsidiaries in the United States and other countries. Other trademarks used herein are the property of IDT or their respective third party owners. For datasheet type definitions and a glossary of common terms, visit www.idt.com/go/glossary. Integrated Device Technology, Inc. All rights reserved.

REVISIONS			
REV	DESCRIPTION	DATE	APPROVED
00	INITIAL RELEASE	04/2/12	DP
01	ADDED LID IN TOP VIEW	07/12/12	KS
02	UPDATED LID TOLERANCES	12/03/12	KS
03	UPDATE PACKAGE DRAWING	8/8/14	J.HUA

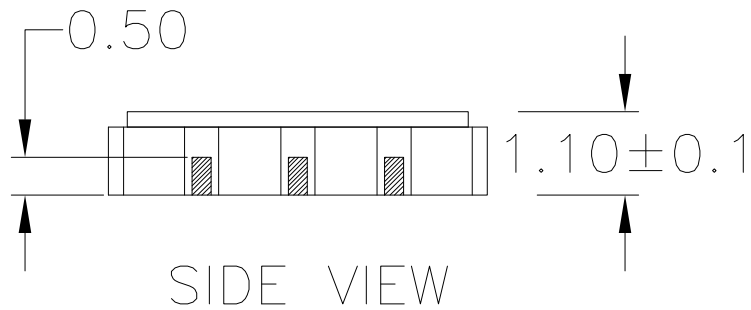
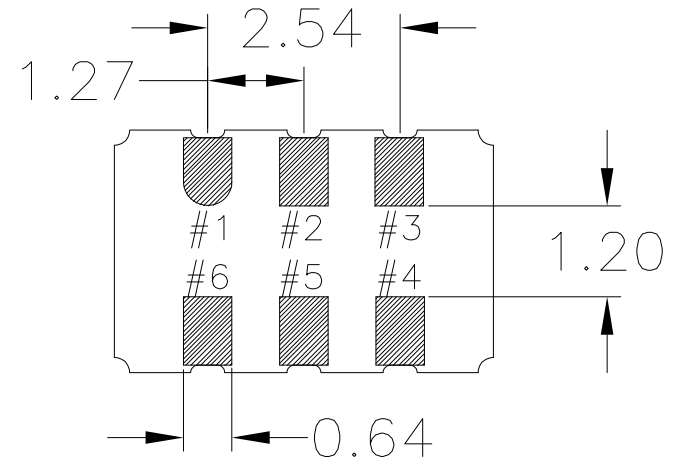
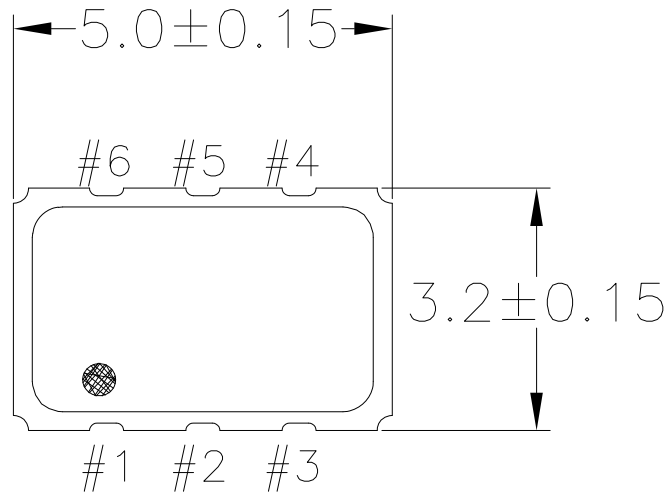

NOTES:

1. ALL DIMENSIONS IN MM.

TOLERANCES UNLESS SPECIFIED		 IDT™ www.IDT.com	6024 Silver Creek Valley Rd San Jose, CA 95138 PHONE: (408) 727-6116 FAX: (408) 492-8674	
DECIMAL	ANGULAR		TITLE JS6 PACKAGE OUTLINE 5.0 x 3.2 mm BODY 1.1 mm Thick	
XX±	±			
XXX±		APPROVALS	DATE	SIZE DRAWING No. C PSC-4411
XXXX±		DRAWN <i>rac</i>	04/2/12	
		CHECKED		DO NOT SCALE DRAWING
				SHEET 1 OF 2

REVISIONS			
REV	DESCRIPTION	DATE	APPROVED
00	INITIAL RELEASE	04/2/12	DP
01	ADDED LID IN TOP VIEW	07/12/12	KS
02	UPDATED LID TOLERANCES	12/03/12	KS
03	UPDATE PACKAGE DRAWING	8/8/14	J.HUA

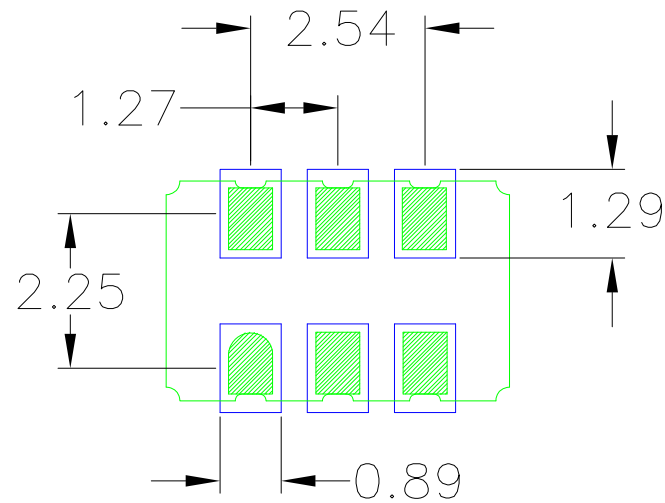

RECOMMENDED LAND PATTERN

NOTES:

1. ALL DIMENSION ARE IN mm. ANGLES IN DEGREES.
2. TOP DOWN VIEW. AS VIEWED ON PCB.
3. COMPONENT OUTLINE SHOW FOR REFERENCE IN GREEN.
4. LAND PATTERN IN BLUE. NSMD PATTERN ASSUMED.
5. LAND PATTERN RECOMMENDATION PER IPC-7351B GENERIC REQUIREMENT FOR SURFACE MOUNT DESIGN AND LAND PATTERN.

TOLERANCES UNLESS SPECIFIED		 www.IDT.com 6024 Silver Creek Valley Rd San Jose, CA 95138 PHONE: (408) 727-6116 FAX: (408) 492-8674
DECIMAL	ANGULAR	
XXX±	±	
XXXX±		
APPROVALS	DATE	TITLE
DRAWN <i>RAE</i>	04/2/12	JS6 PACKAGE OUTLINE 5.0 x 3.2 mm BODY 1.1 mm Thick
CHECKED		
	SIZE	DRAWING No.
	C	PSC-4411
		REV
		03
DO NOT SCALE DRAWING		SHEET 2 OF 2

REVISIONS			
REV	DESCRIPTION	DATE CREATED	AUTHOR
00	INITIAL RELEASE	8/11/14	J.HUA
01	ADD PITCH	11/17/16	J.HUA
REFER TO DCP FOR OFFICIAL RELEASE DATE			

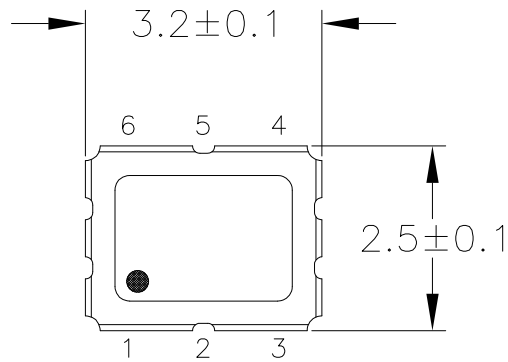

TOP VIEW

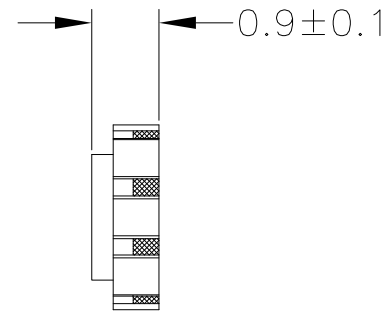

END VIEW

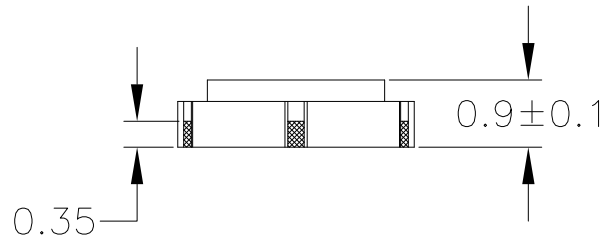

SIDE VIEW

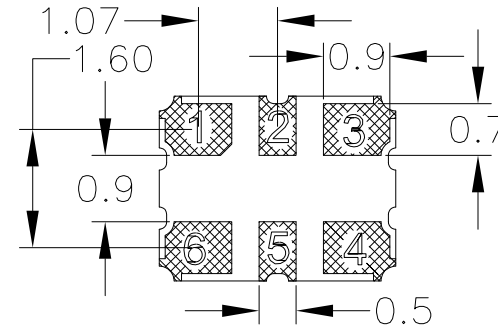

BOTTOM VIEW

NOTES:

1. ALL DIMENSIONS IN MM.

TOLERANCES UNLESS SPECIFIED		 6024 Silver Creek Valley Rd San Jose, CA 95138 PHONE: (408) 727-6116 FAX: (408) 492-8674 www.IDT.com
DECIMAL	ANGULAR	
XX±	±	
XXX±		
XXXX±		
TITLE		JX6 PACKAGE OUTLINE
		3.2 x 2.5 mm BODY
		0.9 mm Thick
SIZE	DRAWING No.	REV
C	PSC-4412	01
DO NOT SCALE DRAWING		SHEET 1 OF 2

REVISIONS			
REV	DESCRIPTION	DATE CREATED	AUTHOR
00	INITIAL RELEASE	8/11/14	J.HUA
01	ADD PITCH	11/17/16	J.HUA
REFER TO DCP FOR OFFICIAL RELEASE DATE			

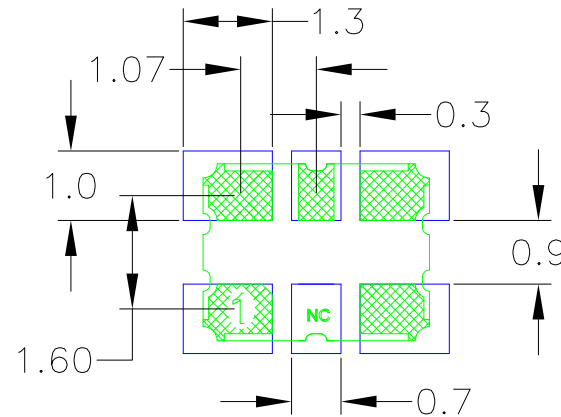

RECOMMENDED LAND PATTERN DIMENSION

NOTES:

1. ALL DIMENSIONS ARE IN MM. ANGLES IN DEGREES.
2. TOP DOWN VIEW. AS VIEWED ON PCB.
3. COMPONENT OUTLINE SHOWS FOR REFERENCE IN GREEN.
4. LAND PATTERN IN BLUE. NSMD PATTERN ASSUMED.
5. LAND PATTERN RECOMMENDATION PER IPC-7351B GENERIC REQUIREMENT FOR SURFACE MOUNT DESIGN AND LAND PATTERN.

TOLERANCES UNLESS SPECIFIED		 IDT 6024 Silver Creek Valley Rd San Jose, CA 95138 PHONE: (408) 727-6116 FAX: (408) 492-8674 www.IDT.com
DECIMAL	ANGULAR	
XX±	±	
XXX±		
XXXX±		
TITLE		JX6 PACKAGE OUTLINE 3.2 x 2.5 mm BODY 0.9 mm Thick
SIZE	DRAWING No.	REV
C	PSC-4412	01
DO NOT SCALE DRAWING		SHEET 2 OF 2

REVISIONS			
REV	DESCRIPTION	DATE	APPROVED
00	INITIAL RELEASE	08/21/12	K. Stahn
01	UPDATED LID TOLERANCES	12/03/12	K. Stahn
02	UPDATE PACKAGE DRAWING	8/8/14	J.HUA

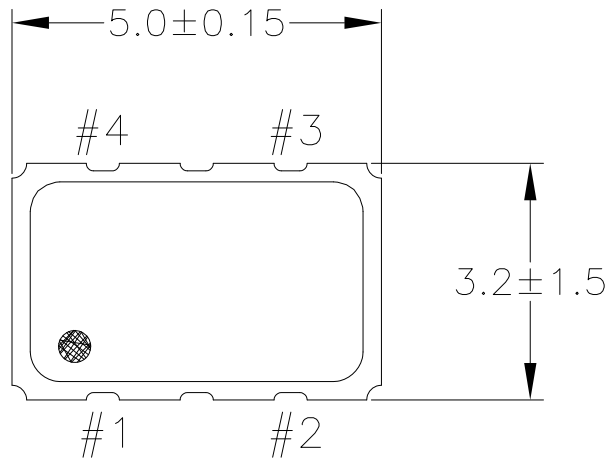

TOP VIEW

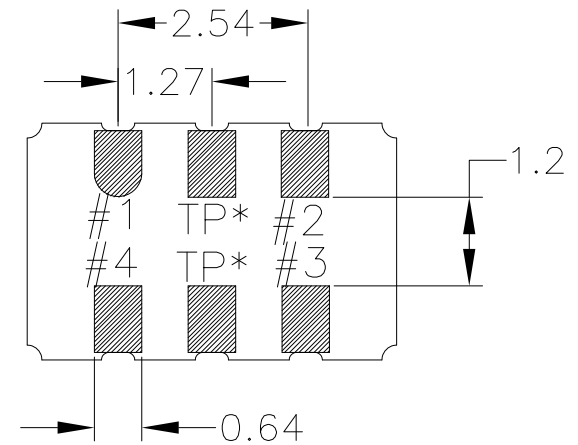

BOTTOM VIEW

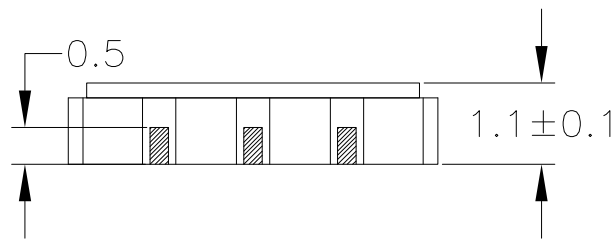

SIDE VIEW

NOTES:
1. ALL DIMENSIONS IN MM.

TOLERANCES UNLESS SPECIFIED		 6024 Silver Creek Valley Rd San Jose, CA 95138 PHONE: (408) 727-6116 FAX: (408) 492-8674 www.IDT.com	
DECIMAL	ANGULAR		
XX±	±		
XXX±			
XXXX±			
APPROVALS	DATE	TITLE	
DRAWN <i>[Signature]</i>	07/16/12	JS4 PACKAGE OUTLINE	
CHECKED		5.0 x 3.2 mm BODY	
		1.1 mm Thick	
	SIZE	DRAWING No.	REV
	C	PSC-4429	02
DO NOT SCALE DRAWING		SHEET 1 OF 2	

REVISIONS			
REV	DESCRIPTION	DATE	APPROVED
00	INITIAL RELEASE	08/21/12	K. Stahn
01	UPDATED LID TOLERANCES	12/03/12	K. Stahn
02	UPDATE PACKAGE DRAWING	8/8/14	J.HUA

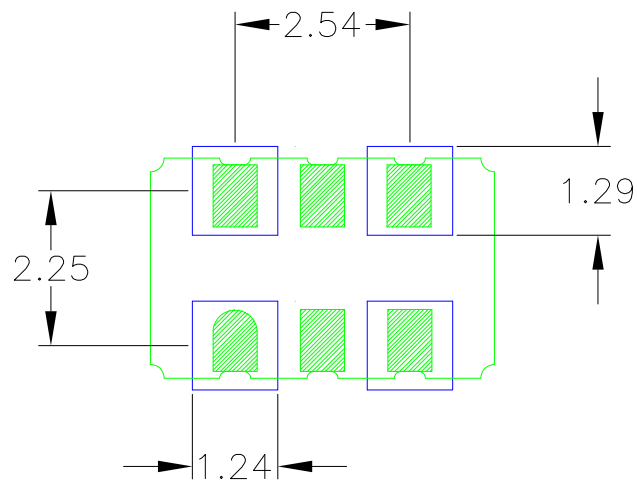

RECOMMENDED LAND PATTERN

NOTES:

1. ALL DIMENSION ARE IN mm. ANGLES IN DEGREES.
2. TOP DOWN VIEW. AS VIEWED ON PCB.
3. COMPONENT OUTLINE SHOW FOR REFERENCE IN GREEN.
4. LAND PATTERN IN BLUE. NSMD PATTERN ASSUMED.
5. LAND PATTERN RECOMMENDATION PER IPC-7351B GENERIC REQUIREMENT FOR SURFACE MOUNT DESIGN AND LAND PATTERN.

TOLERANCES UNLESS SPECIFIED		 IDT™ www.IDT.com 6024 Silver Creek Valley Rd San Jose, CA 95138 PHONE: (408) 727-6116 FAX: (408) 492-8674	
DECIMAL	ANGULAR		
XX±	±		
XXX±			
APPROVALS	DATE	TITLE	
DRAWN <i>gls</i>	07/16/12	JS4 PACKAGE OUTLINE	
CHECKED		5.0 x 3.2 mm BODY	
		1.1 mm Thick	
	SIZE	DRAWING No.	REV
	C	PSC-4429	02
DO NOT SCALE DRAWING		SHEET 2 OF 2	

REVISIONS			
REV	DESCRIPTION	DATE	APPROVED
00	INITIAL RELEASE	8/8/14	J.HUA
01	ADD OPTION 1 & 2	4/2/15	J.HUA

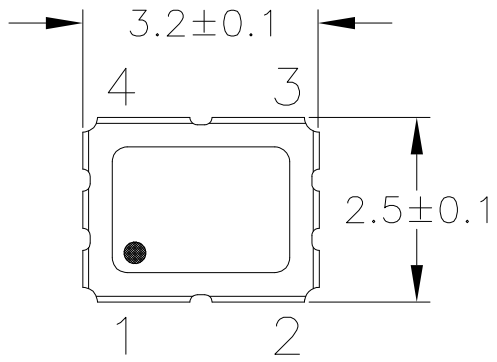

TOP VIEW

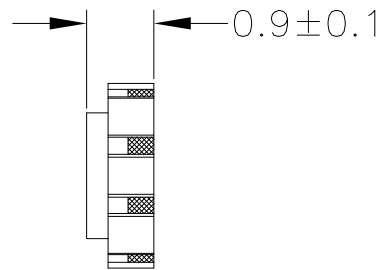

END VIEW

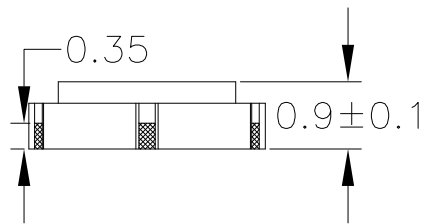

SIDE VIEW

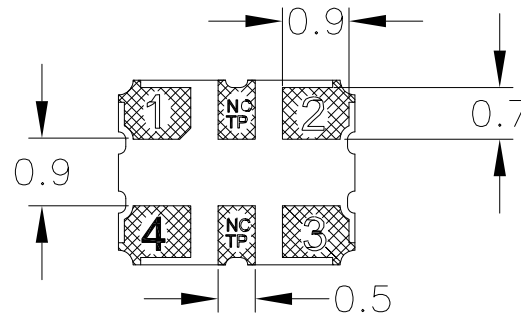

OPTION 1
BOTTOM VIEW

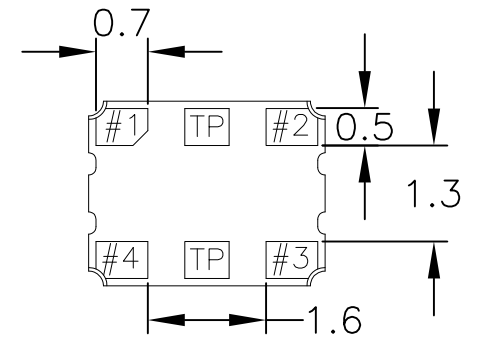

OPTION 2
BOTTOM VIEW

NOTES:
1. ALL DIMENSIONS IN MM.

TOLERANCES UNLESS SPECIFIED		 www.IDT.com	6024 Silver Creek Valley Rd San Jose, CA 95138 PHONE: (408) 727-6116 FAX: (408) 492-8674	
DECIMAL	ANGULAR			
XX±	±			
XXX±				
XXXX±				
APPROVALS	DATE	TITLE JX4 PACKAGE OUTLINE		
DRAWN <i>RAC</i>	8/8/14	3.2 x 2.5 mm BODY		
CHECKED		0.9 mm Thick		
		SIZE	DRAWING No.	REV
		C	PSC-4489	01
DO NOT SCALE DRAWING			SHEET 1 OF 2	

REVISIONS			
REV	DESCRIPTION	DATE	APPROVED
00	INITIAL RELEASE	8/8/14	J.HUA
01	ADD OPTION 1 & 2	4/2/15	J.HUA

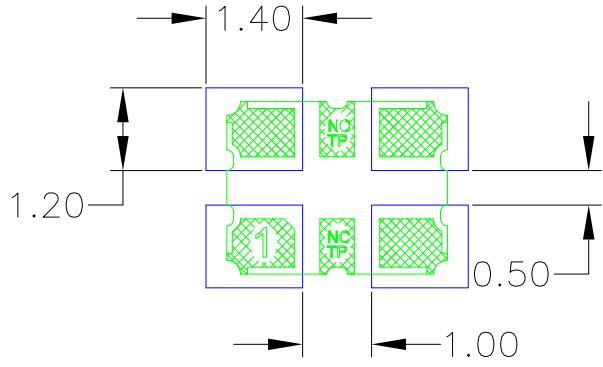

OPTION 1

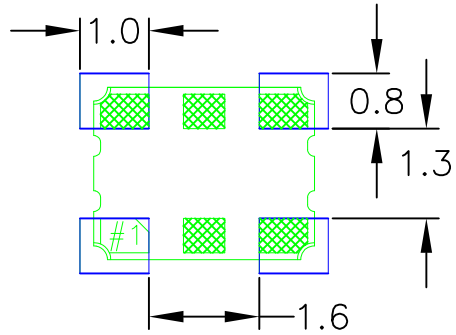

OPTION 2

RECOMMENDED LAND PATTERN

NOTES:

1. ALL DIMENSION ARE IN mm. ANGLES IN DEGREES.
2. TOP DOWN VIEW AS VIEWED ON PCB.
3. COMPONENT OUTLINE SHOWN FOR REFERENCE IN GREEN.
4. LAND PATTERN IN BLUE. NSMD PATTERN ASSUMED.
5. LAND PATTERN RECOMMENDATION PER IPC-7351B GENERIC REQUIREMENT FOR SURFACE MOUNT DESIGN AND LAND PATTERN.

TOLERANCES UNLESS SPECIFIED		 IDT™ 6024 Silver Creek Valley Rd San Jose, CA 95138 PHONE: (408) 727-6116 FAX: (408) 492-8674 www.IDT.com	
DECIMAL	ANGULAR		
XX±	±		
XXX±			
XXXX±			
APPROVALS	DATE	TITLE	
DRAWN <i>ELC</i>	8/8/14	JX4 PACKAGE OUTLINE	
CHECKED		3.2 x 2.5 mm BODY	
		0.9 mm Thick	
	SIZE	DRAWING No.	REV
	C	PSC-4489	01
DO NOT SCALE DRAWING		SHEET 2 OF 2	