

- NOTES:
1. ALL DIMENSIONING AND TOLERANCING CONFORM TO ANSI Y14.5M-1982
  2. ALL DIMENSION ARE IN MM.

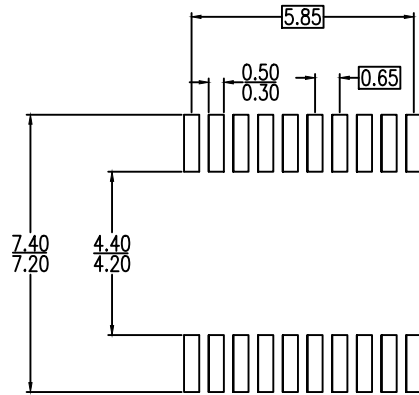

RECOMMENDED LAND PATTERN DIMENSIONS

NOTES:

1. ALL DIMENSIONS ARE IN MILLIMETERS

Package Revision History		
Date Created	Rev No.	Description
July 24, 2018	Rev 00	Initial Release