

# F1152 Low IF Frequency and Lower DC Power Consumption

- May 15, 2014
- Task AT0083

Michael J. Virostko  
Principal Product Application Engineer



---

The Analog and Digital Company™



# Agenda

- Purpose
- Circuit Modifications
- Characterization
- Conclusion



# Purpose

- Customer's application requires a lower DC power consumption of the F1152 Dual Downconverting Mixer.
- Customer also requires that the output IF response work from 25 – 100 MHz.
- Testing was performed in 2013 and a evaluation board was given to the customer.
- After investigation, the IF circuitry on that particular evaluation board was show to be manufactured wrong.
- This testing is being down to confirm the original measurements.
- Along with this the customer added an RF port matching circuit and a modification to the IF output circuit which will be tested.



# Low Frequency IF Circuit Modifications

- IDT's evaluation board (F1150 EV Kit Rev 5) has IF Circuitry for a frequency range of 50 to 300 MHz.

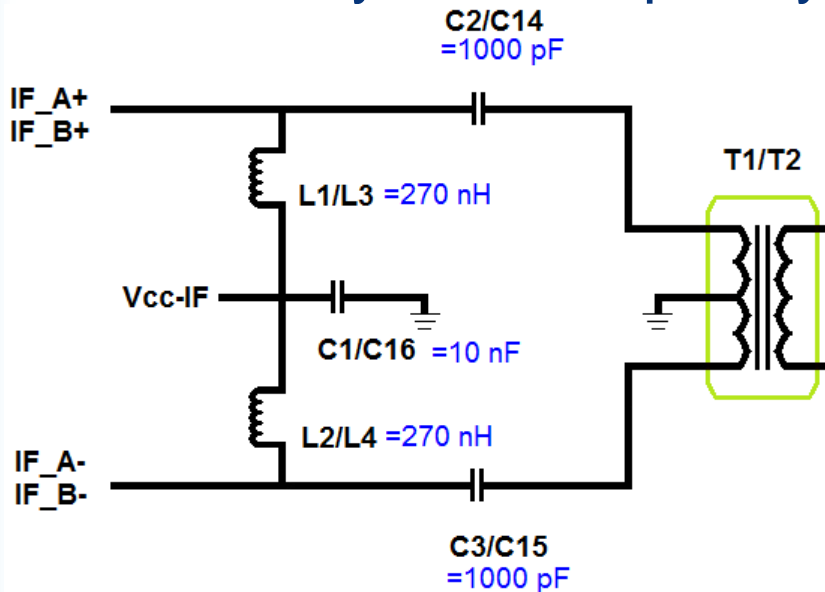

**Standard Evaluation Board IF Circuitry**

**Modified IF Circuitry for 10 MHz Operation**

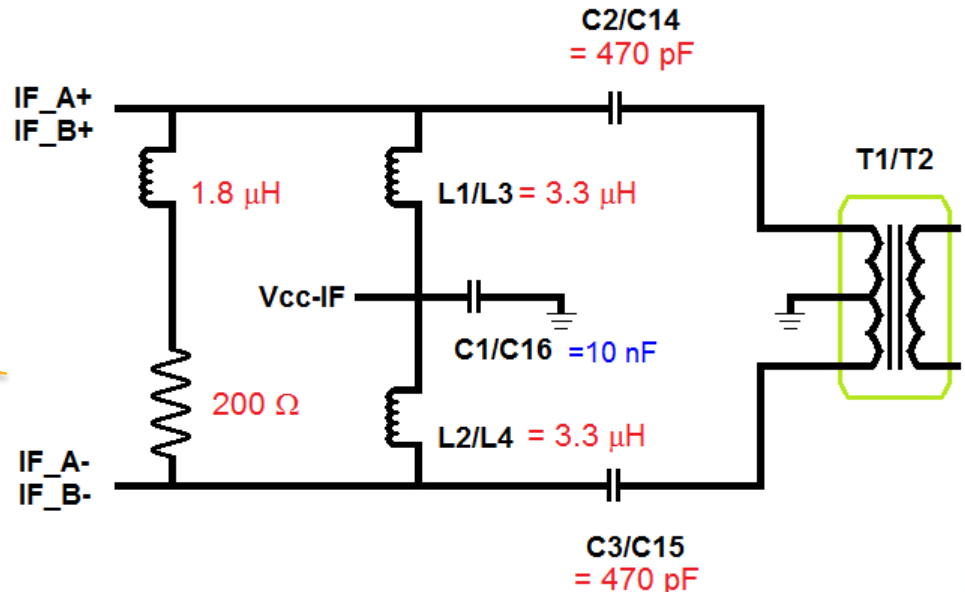

# Characterization – Measurement Parameters

- Data is collected at the end of the evaluation board
  - No loss correction is done
- Low Current mode was used for all measurements. The resistors used are:
  - IF\_BiasA = IF\_BiasB = 62 ohms
  - LO1\_Adj\_Bias = 370 ohms
  - LO2\_Adj\_Bias = 4100 ohms
    - Different from the standard low current mode
- RF frequency was 1.700 and 1.900 GHz
- LO swept for both high and low side injection
- IF swept



# Characterization – Measurement Parameters

- The Voltage applied to the IF circuit ( $V_{cc-IF}$ ) was changed from 5.0 to 3.3 V.
- $V_{cc-IF}$  must be turned on before  $V_{cc}$ .
- The current variation is in the 10's of  $\mu A$ . The nominal current is 53.9 mA for either applied voltage.
- DC Power is calculated for the entire device (both Channels).
- RF data was only collected on Channel B.



# Low IF Circuit – Gain, High Side LO

F1152 RFto IF Dual Downconverting Mixer  
Vcc-IF= +3.3 V, Vcc = +5.0 V, Low Frequency IF Circuitry  
RF Fixed Frequency, High Side LO Injection (RF < LO), IF = LO - RF

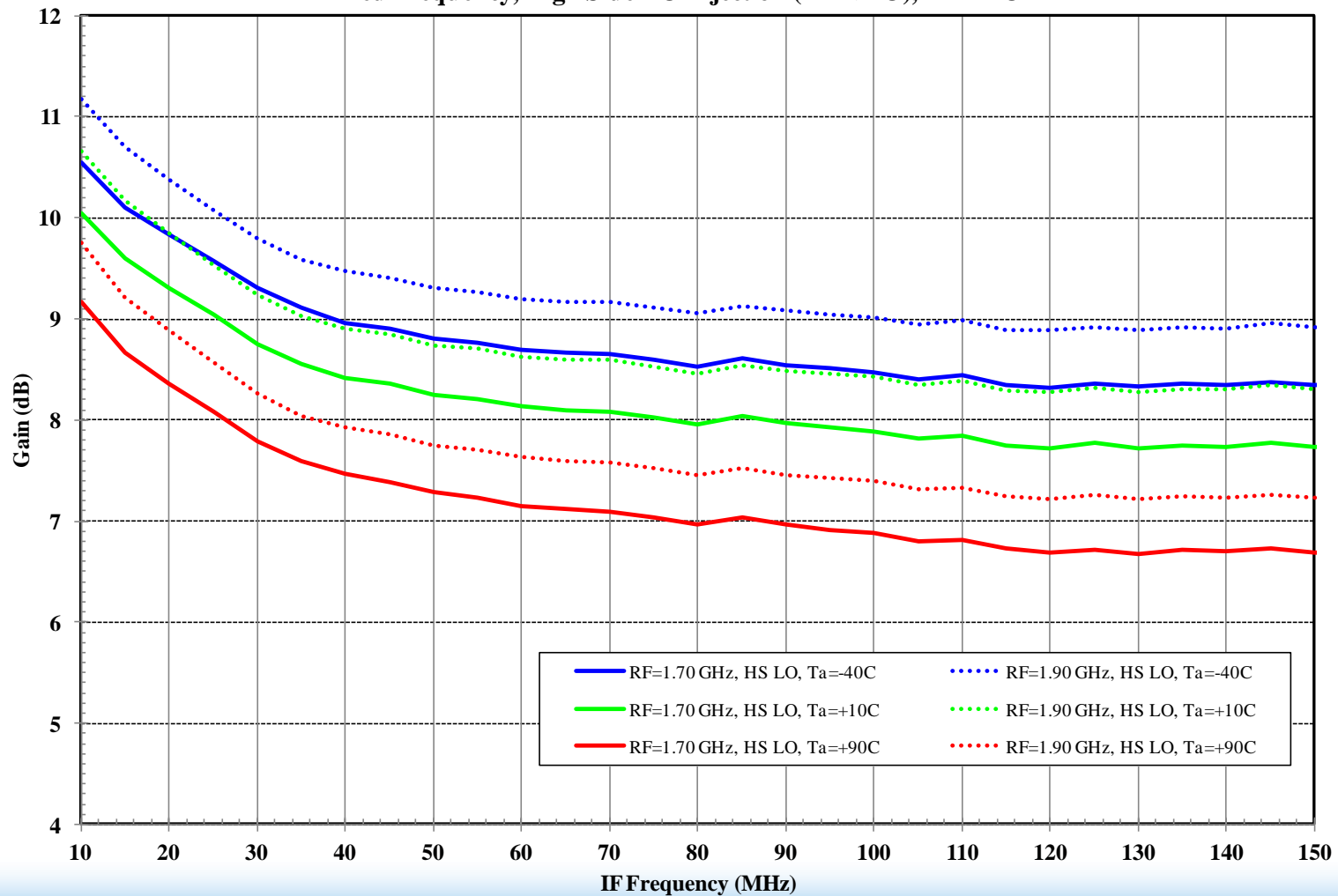

# Low IF Circuit – Gain, Low Side LO

F1152 RF to IF Dual Downconverting Mixer  
Vcc-IF = +3.3 V, Vcc = +5.0 V, Low Frequency IF Circuitry  
RF Fixed Frequency, Low Side LO Injection (RF > LO), IF = RF - LO

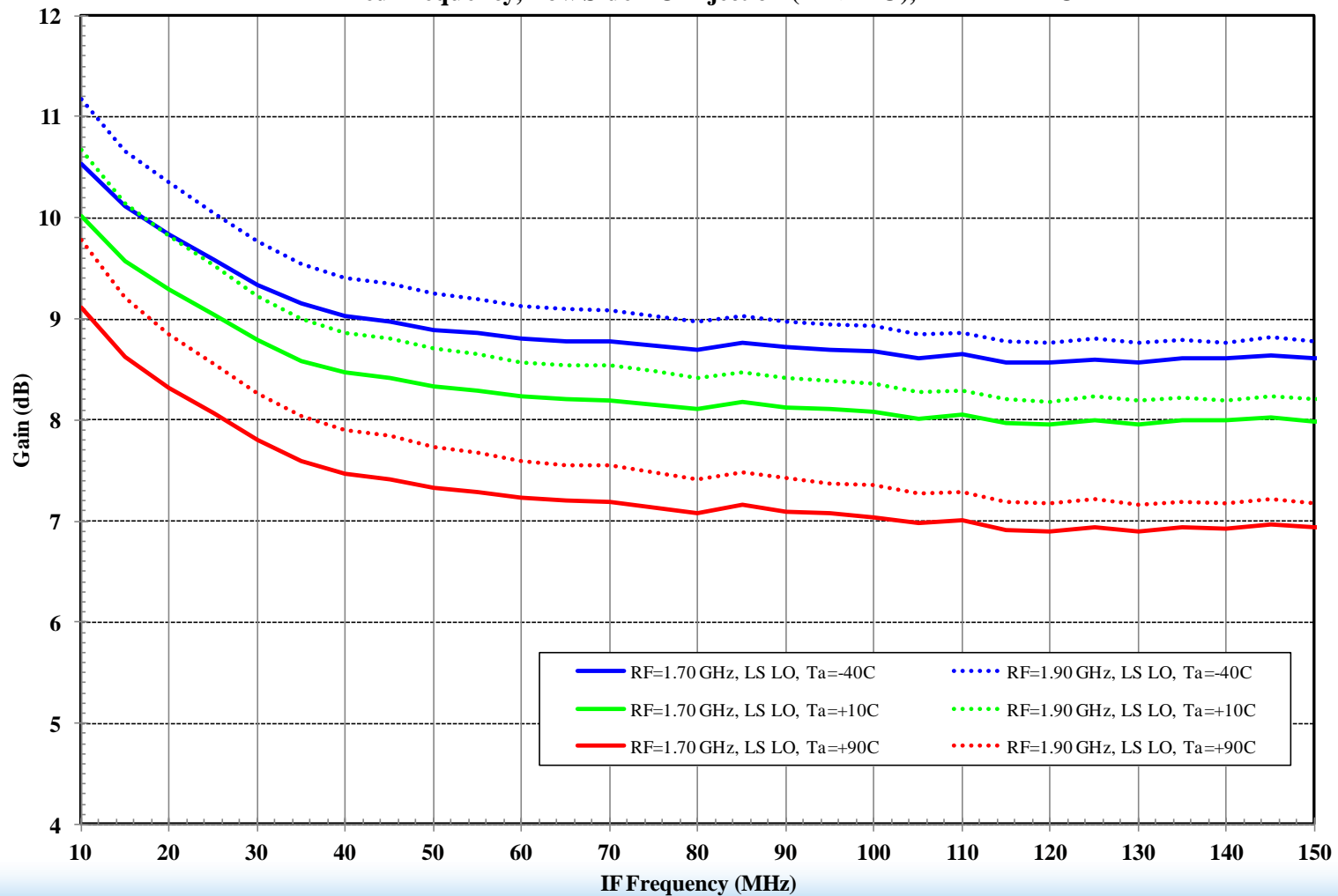



# Low IF Circuit – OIP3, High Side LO

F1152 RFto IF Dual Downconverting Mixer  
Vcc-IF= +3.3 V, Vcc = +5.0 V, Low Frequency IF Circuitry  
RF Fixed Frequency, High Side LO Injection (RF < LO), IF = LO - RF

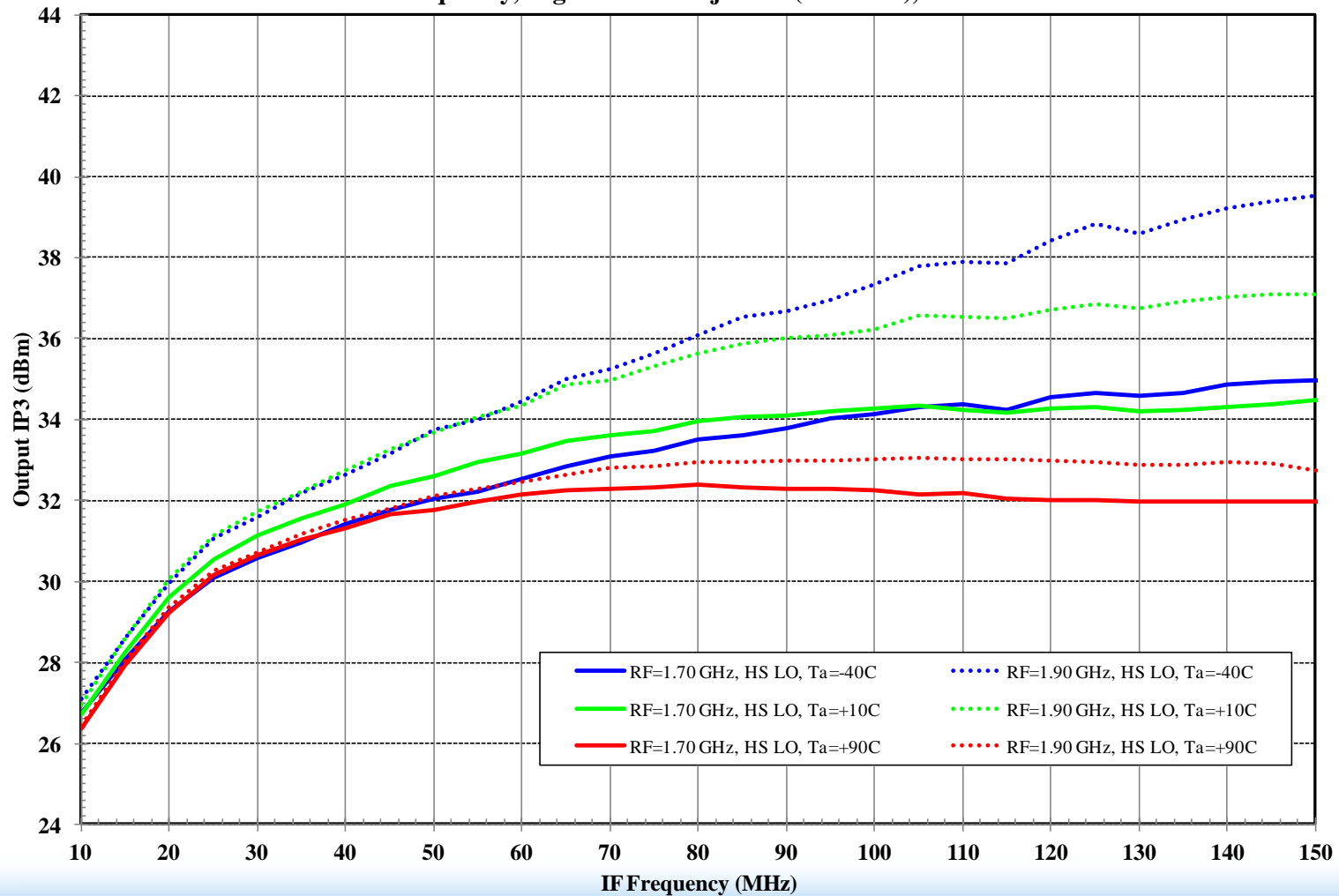

# Low IF Circuit – OIP3, Low Side LO

F1152 RF to IF Dual Downconverting Mixer  
Vcc-IF = +3.3 V, Vcc = +5.0 V, Low Frequency IF Circuitry  
RF Fixed Frequency, Low Side LO Injection (RF > LO), IF = RF - LO

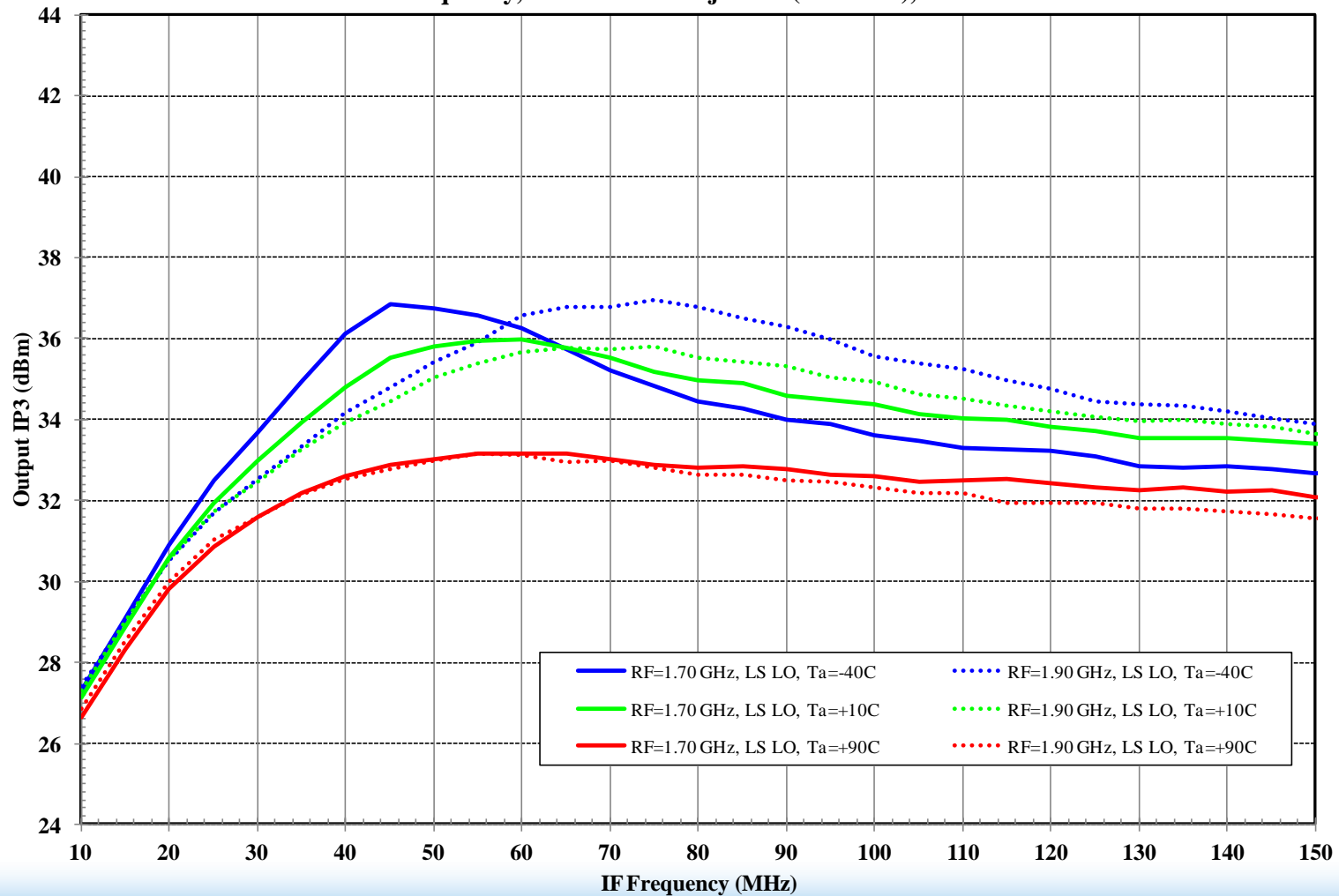

# Low IF Circuit – IIP3, High Side LO

F1152 RFto IF Dual Downconverting Mixer  
Vcc-IF= +3.3 V, Vcc = +5.0 V, Low Frequency IF Circuitry  
RF Fixed Frequency, High Side LO Injection (RF < LO), IF = LO - RF

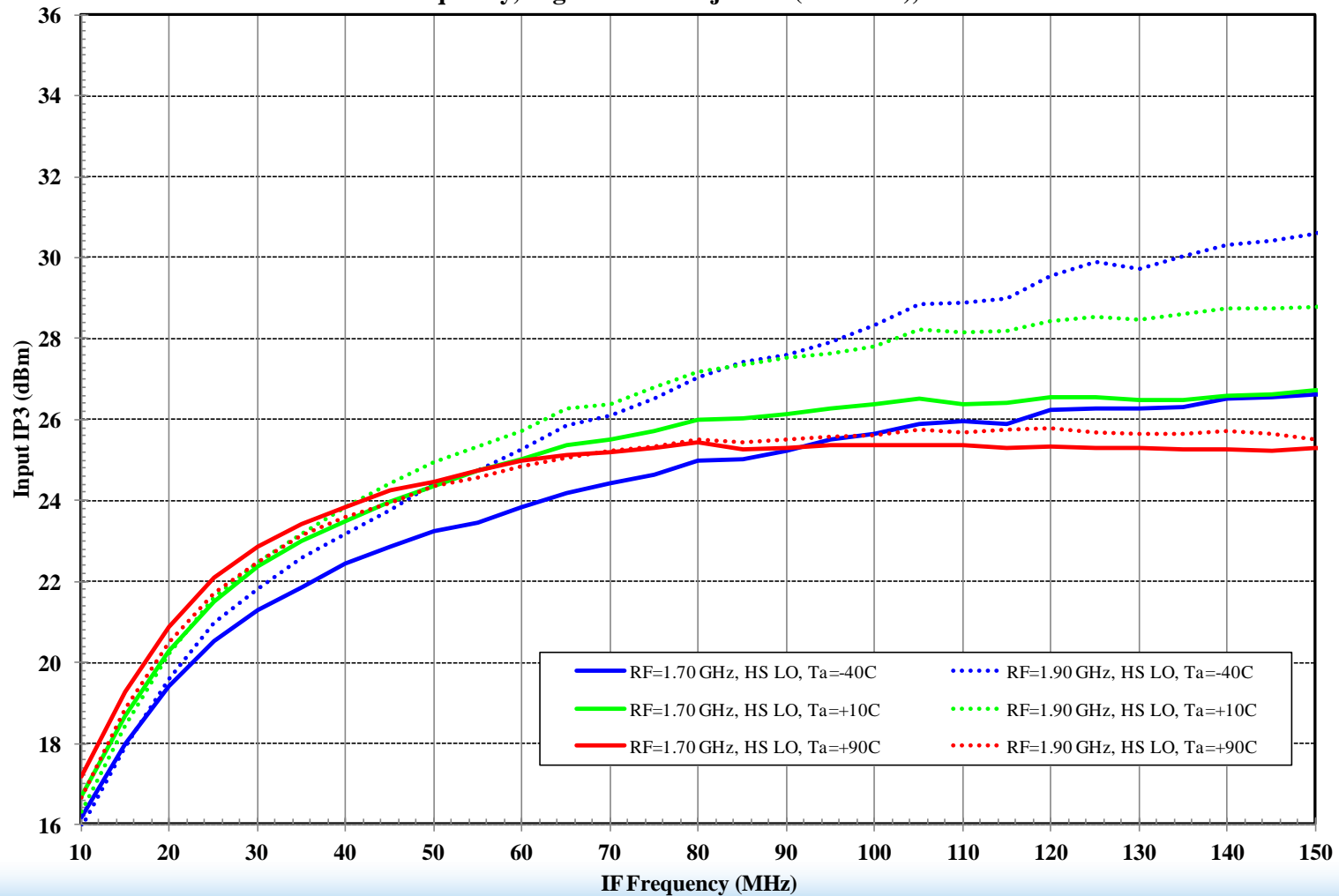

# Low IF Circuit – IIP3, Low Side LO

F1152 RF to IF Dual Downconverting Mixer  
Vcc-IF = +3.3 V, Vcc = +5.0 V, Low Frequency IF Circuitry  
RF Fixed Frequency, Low Side LO Injection (RF > LO), IF = RF - LO

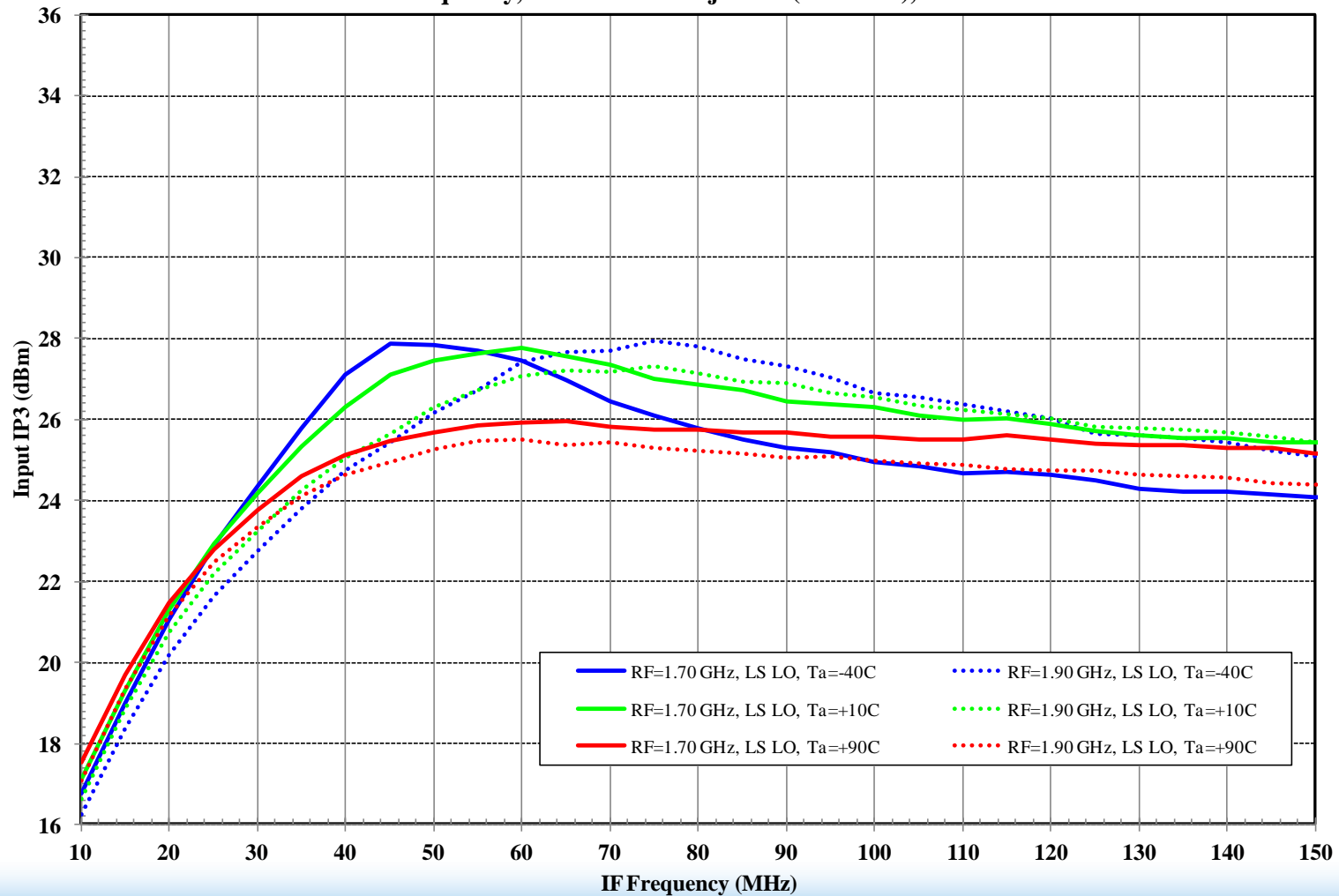

# Low IF Circuit – DC Power, High Side LO

F1152 RFto IF Dual Downconverting Mixer  
Vcc-IF= +3.3 V, Vcc = +5.0 V, Low Frequency IF Circuitry  
RF Fixed Frequency, High Side LO Injection (RF < LO), IF = LO - RF

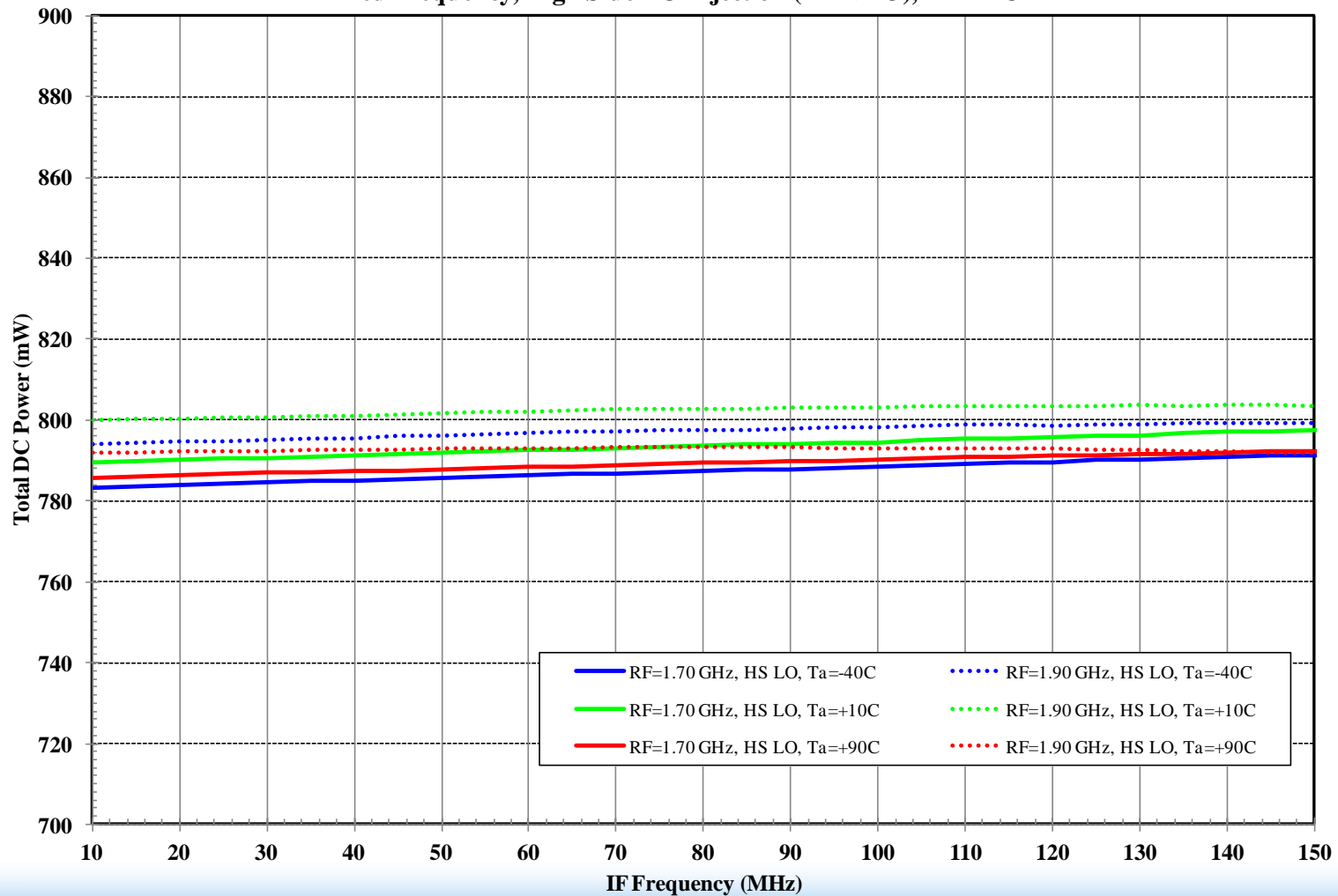

# Low IF Circuit – DC Power, Low Side LO

F1152 RF to IF Dual Downconverting Mixer  
Vcc-IF = +3.3 V, Vcc = +5.0 V, Low Frequency IF Circuitry  
RF Fixed Frequency, Low Side LO Injection (RF > LO), IF = RF - LO

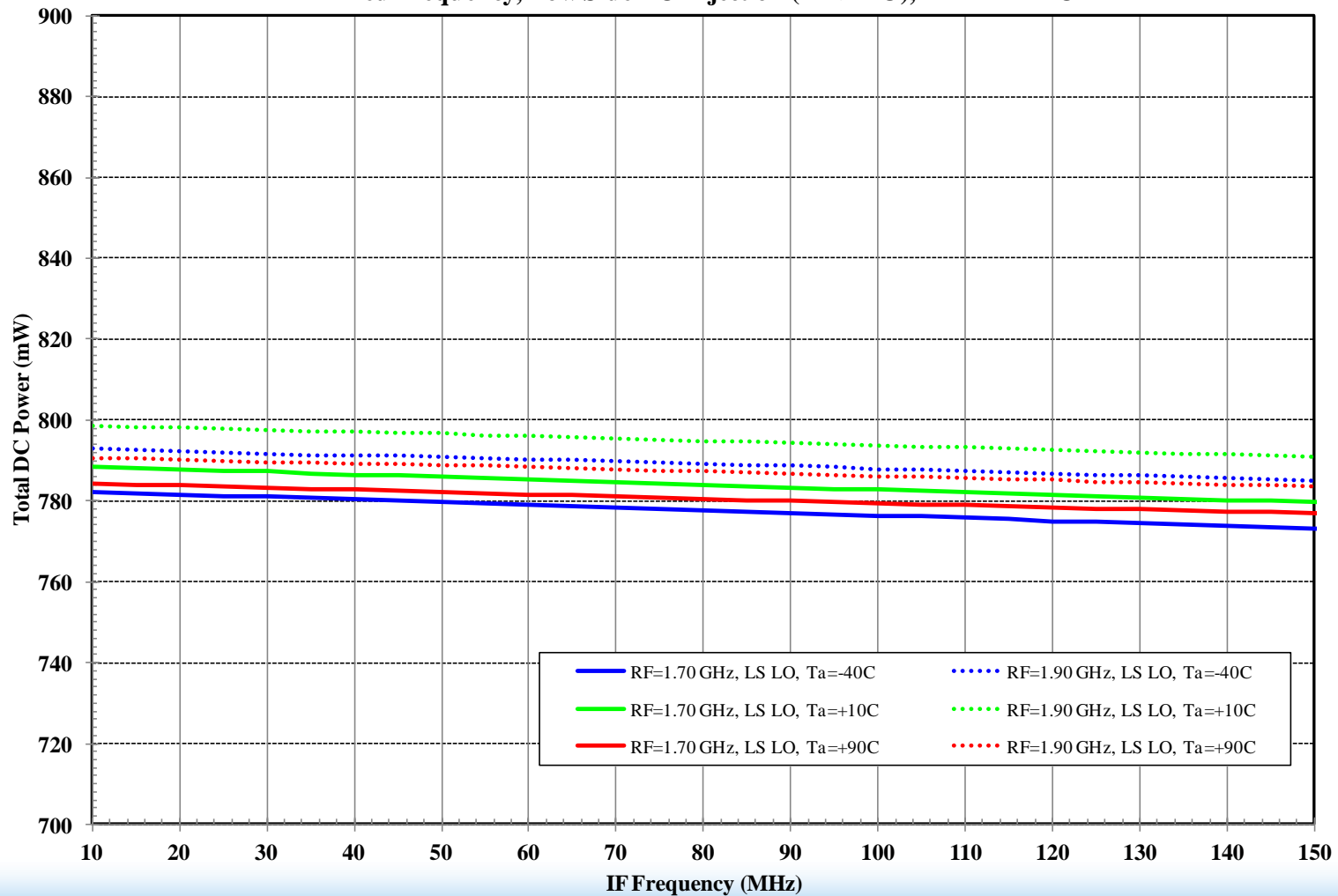

# Low IF Circuit – OP1dB, High Side LO

F1152 RFto IF Dual Downconverting Mixer  
Vcc-IF= +3.3 V, Vcc = +5.0 V, Low Frequency IF Circuitry  
RF Fixed Frequency, High Side LO Injection (RF < LO), IF = LO - RF

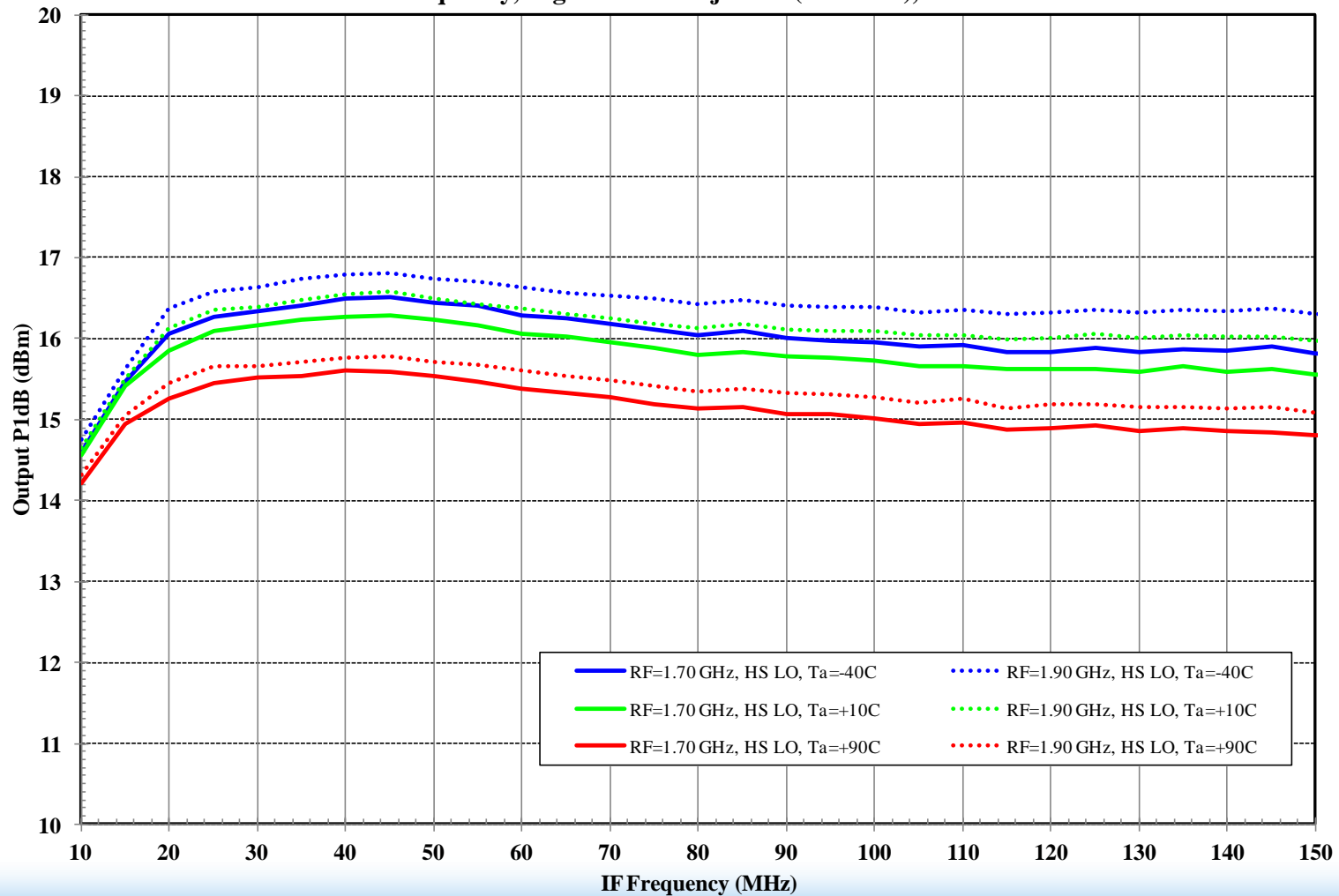

# Low IF Circuit – OP1dB, Low Side LO

F1152 RF to IF Dual Downconverting Mixer  
Vcc-IF = +3.3 V, Vcc = +5.0 V, Low Frequency IF Circuitry  
RF Fixed Frequency, Low Side LO Injection (RF > LO), IF = RF - LO

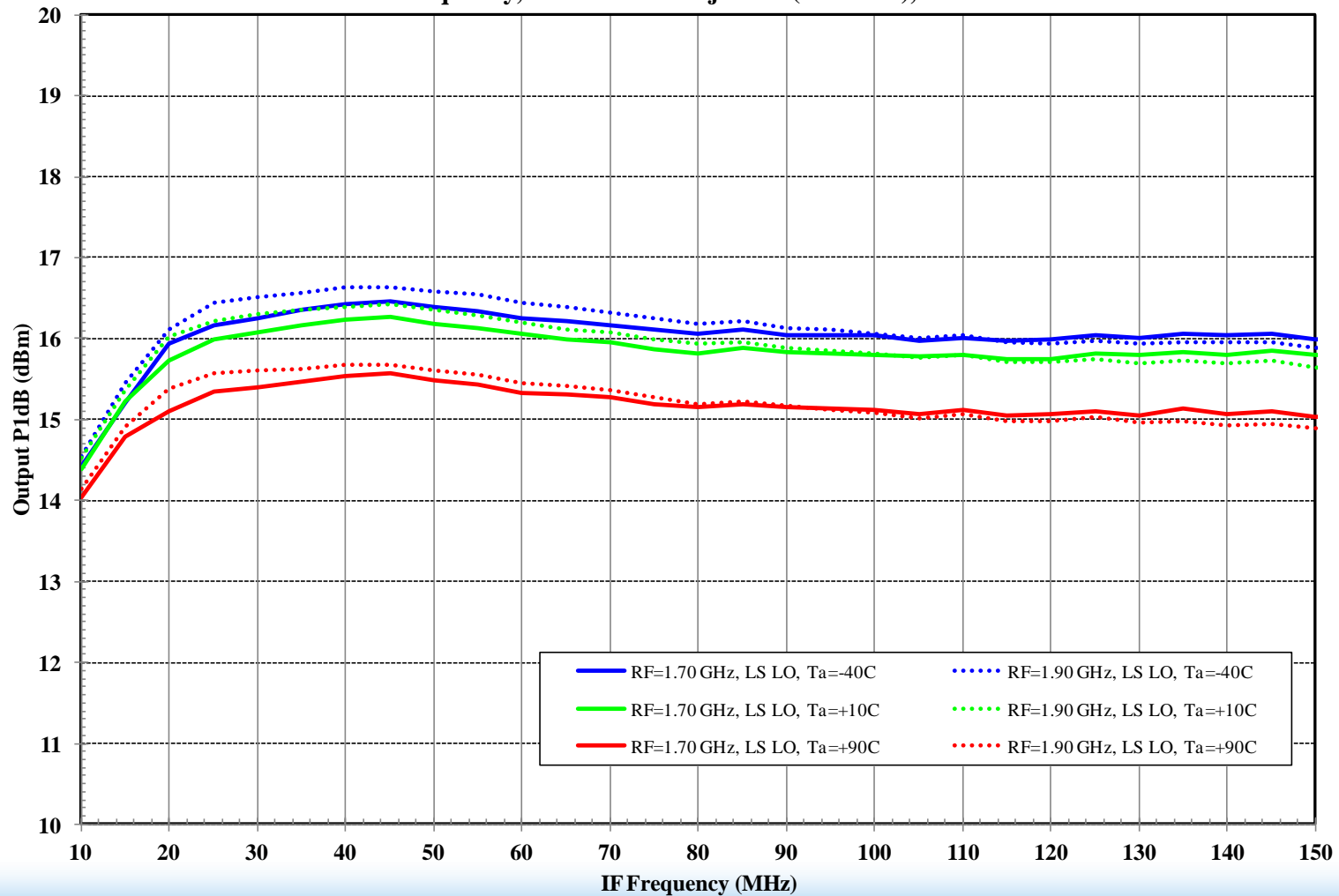



# Low IF Circuit – OIP2, High Side LO

F1152 RFto IF Dual Downconverting Mixer  
Vcc-IF= +3.3 V, Vcc = +5.0 V, Low Frequency IF Circuitry  
RF Fixed Frequency, High Side LO Injection (RF < LO), IF = LO - RF

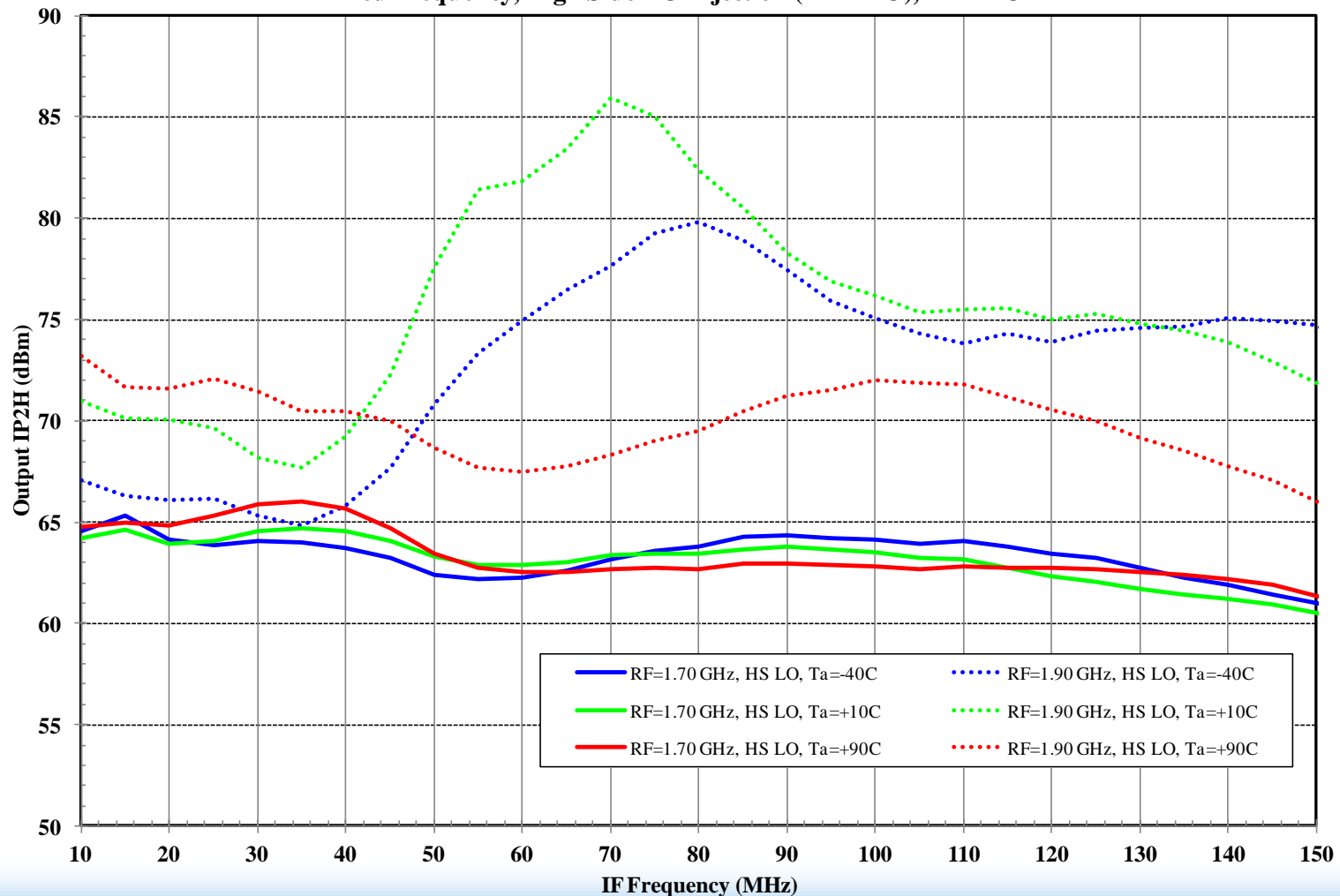

# Low IF Circuit – OIP2, Low Side LO

F1152 RF to IF Dual Downconverting Mixer  
Vcc-IF = +3.3 V, Vcc = +5.0 V, Low Frequency IF Circuitry  
RF Fixed Frequency, Low Side LO Injection (RF > LO), IF = RF - LO

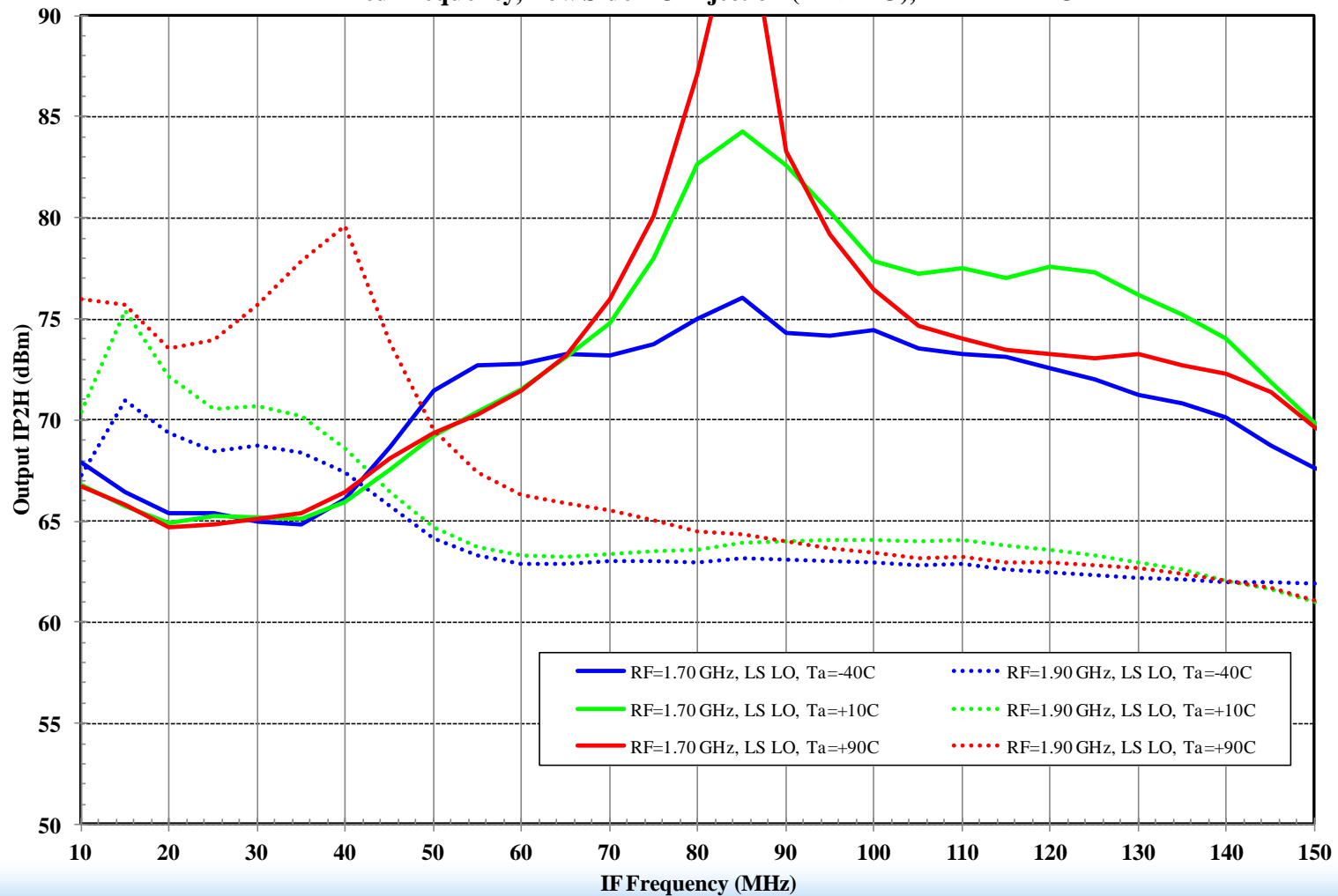

# Low IF Circuit – 2x2 Rejection, High Side LO

F1152 RFto IF Dual Downconverting Mixer  
Vcc-IF= +3.3 V, Vcc = +5.0 V, Low Frequency IF Circuitry  
RF Fixed Frequency, High Side LO Injection (RF < LO), IF = LO - RF

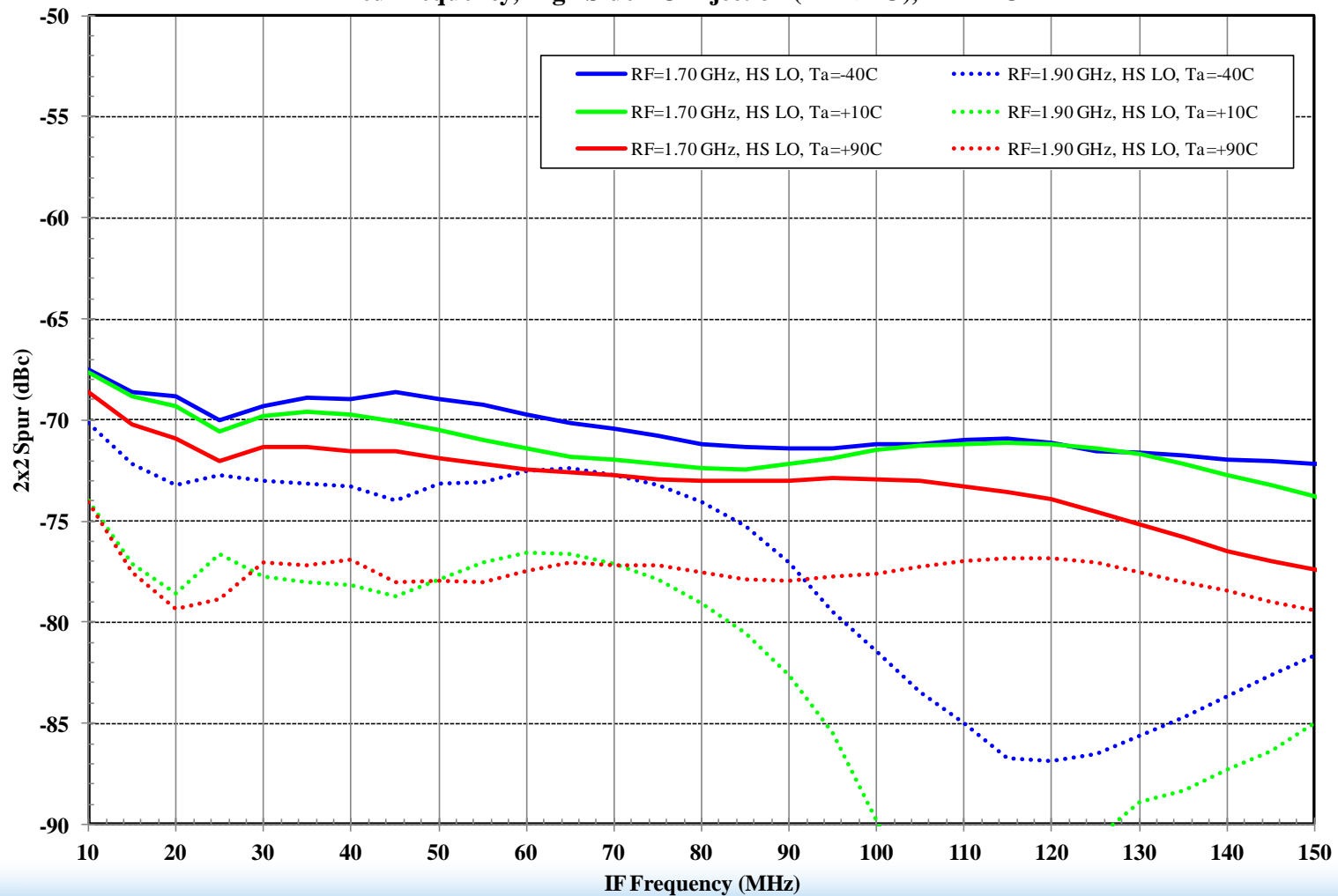

# Low IF Circuit – 2x2 Rejection, Low Side LO

F1152 RF to IF Dual Downconverting Mixer  
Vcc-IF = +3.3 V, Vcc = +5.0 V, Low Frequency IF Circuitry  
RF Fixed Frequency, Low Side LO Injection (RF > LO), IF = RF - LO

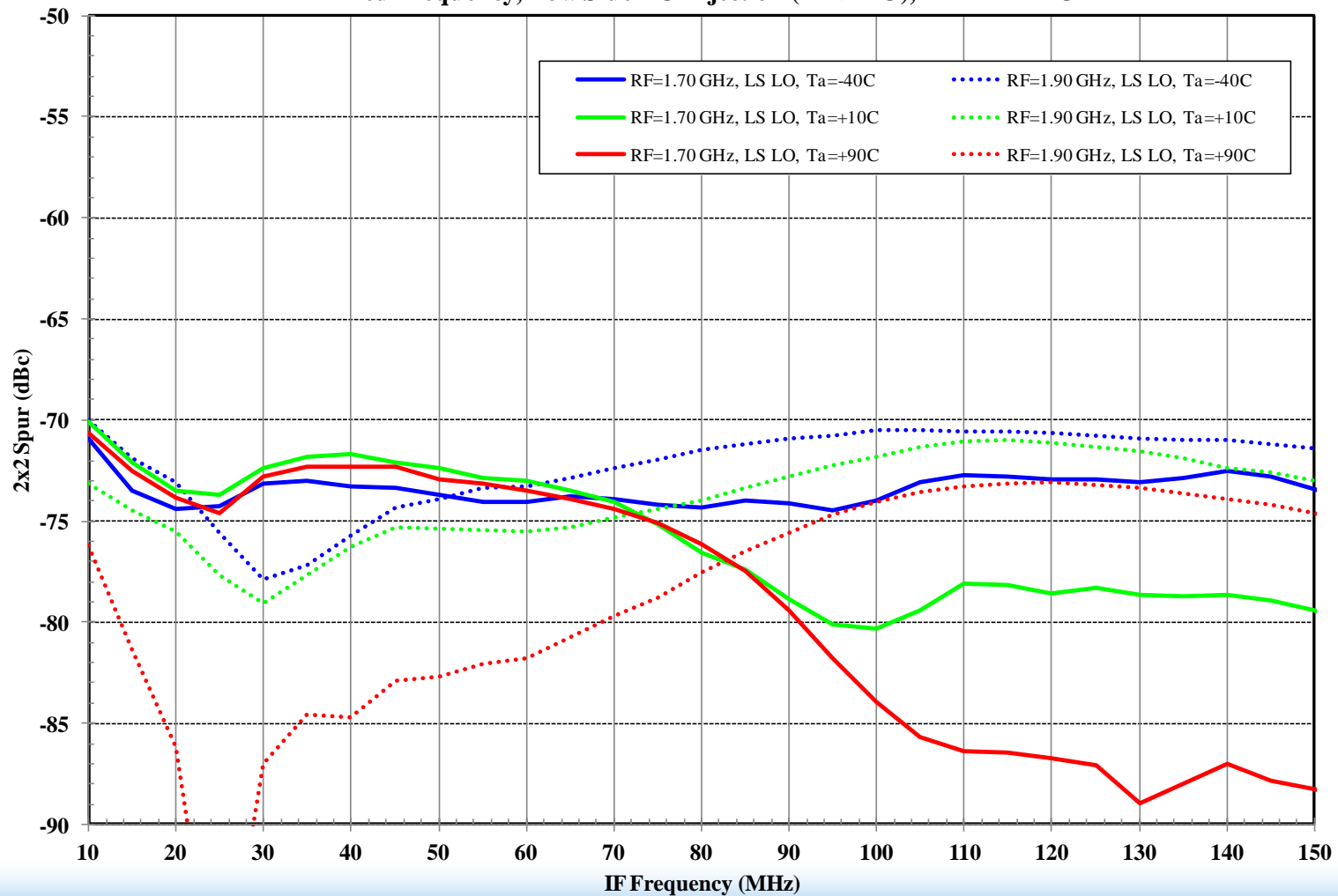

# Low IF Circuit – 3x3 Rejection, High Side LO

F1152 RFto IF Dual Downconverting Mixer  
Vcc-IF= +3.3 V, Vcc = +5.0 V, Low Frequency IF Circuitry  
RF Fixed Frequency, High Side LO Injection (RF < LO), IF = LO - RF

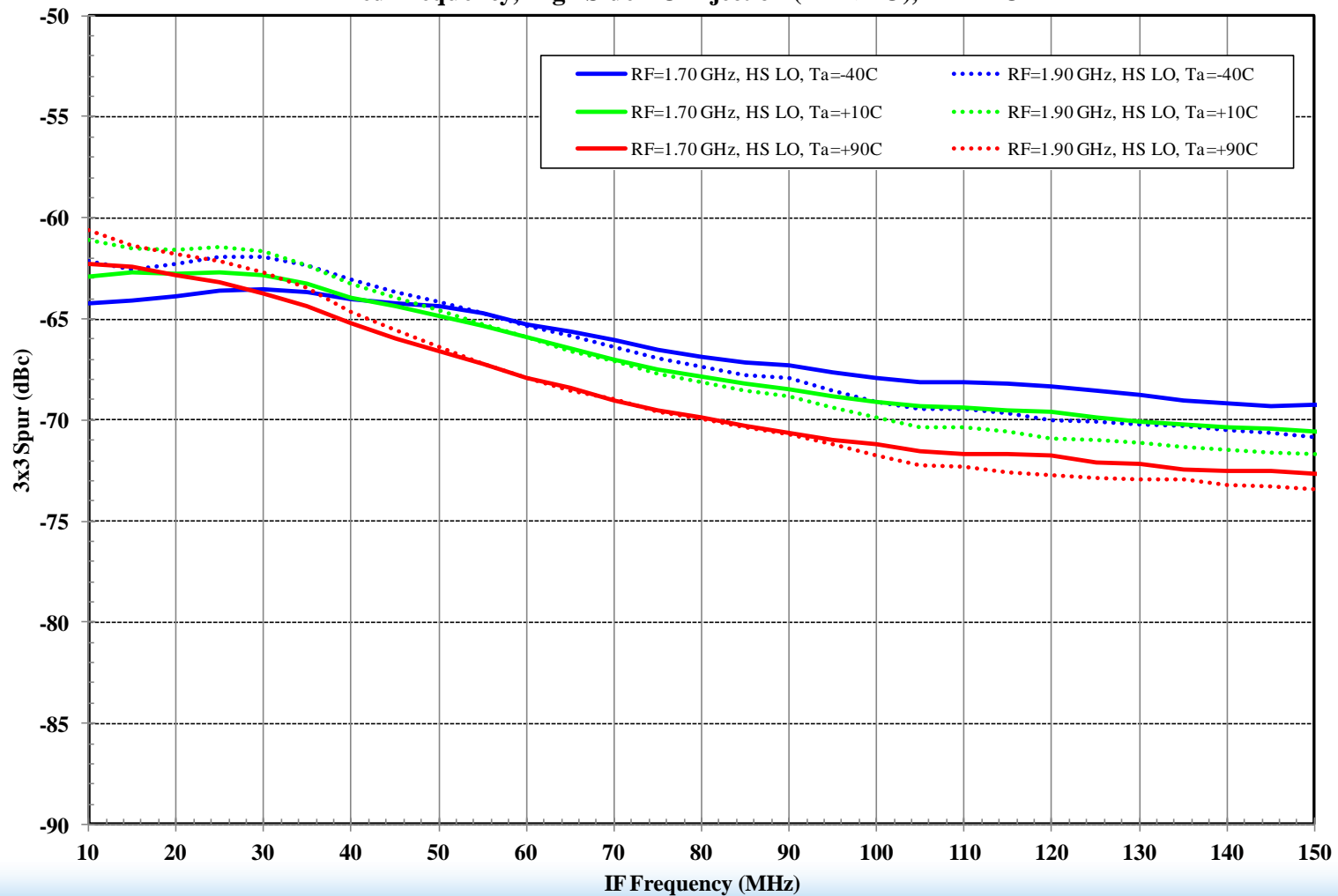

# Low IF Circuit – 3x3 Rejection, Low Side LO

F1152 RF to IF Dual Downconverting Mixer  
Vcc-IF = +3.3 V, Vcc = +5.0 V, Low Frequency IF Circuitry  
RF Fixed Frequency, Low Side LO Injection (RF > LO), IF = RF - LO

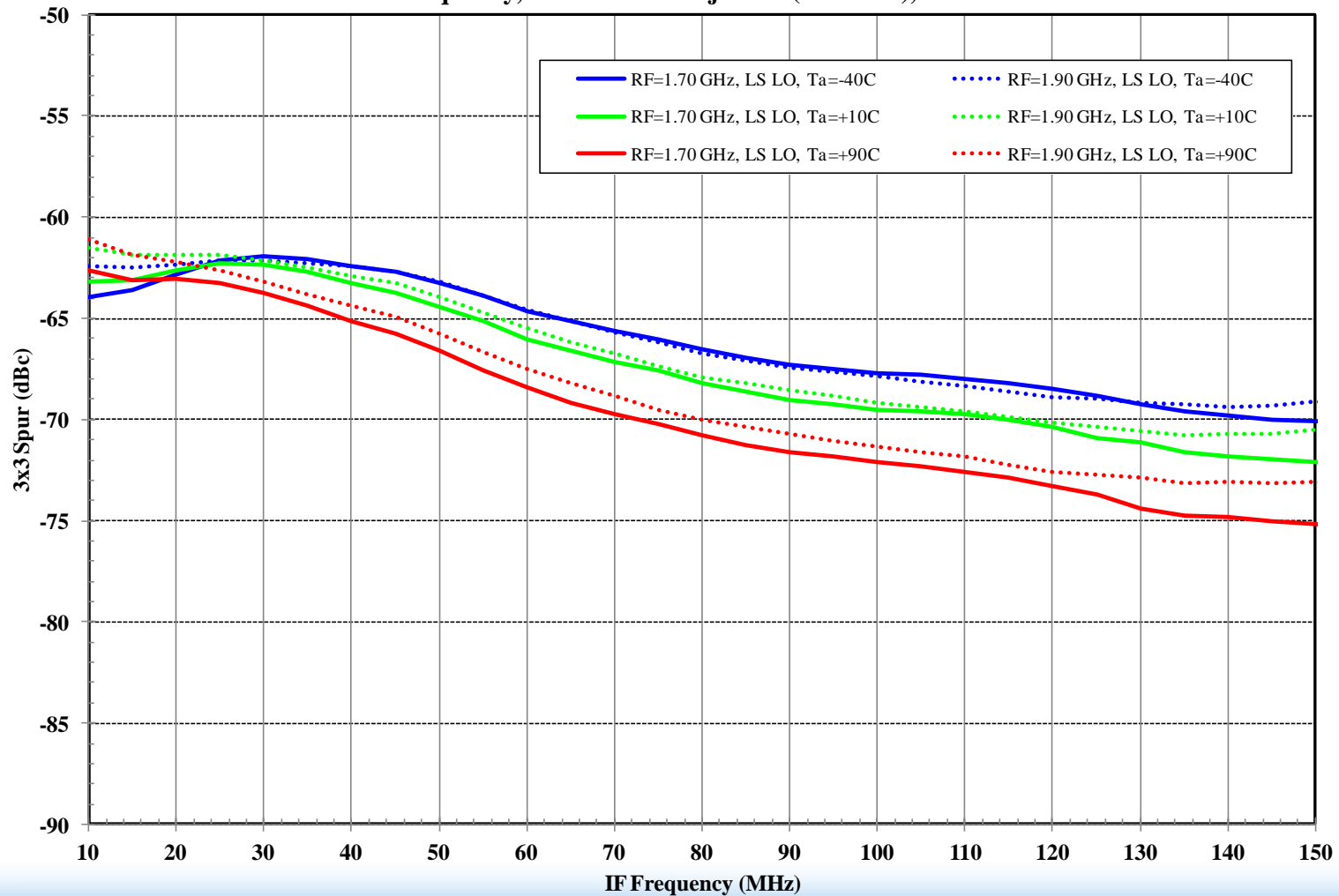

# RF Circuit Modifications

- IDT's evaluation board was modified for the customer's RF circuitry.

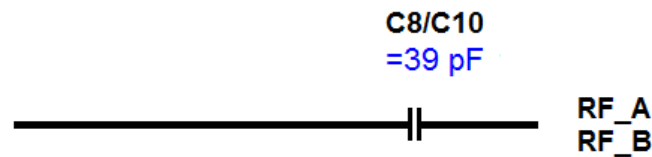

**Standard Evaluation  
Board RF Circuitry**

**Modified RF Circuitry  
for Customer's use**

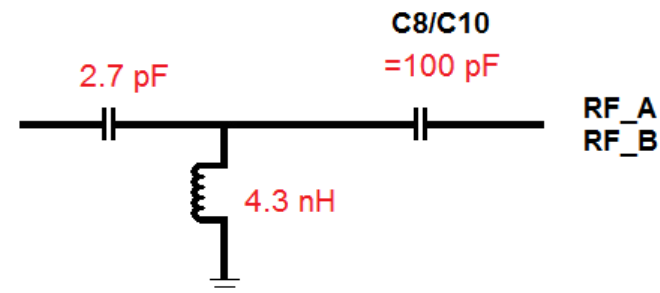

# RF Match – Measurement Parameters

- The measurements were done exactly the same as the Low IF circuitry testing.





# RF Match – Gain, High Side LO

F1152 RFto IF Dual Downconverting Mixer  
Vcc-IF= +3.3 V, Vcc = +5.0 V, Low Frequency IF Circuitry, **RF Port Match**  
RF Fixed Frequency, High Side LO Injection (RF < LO), IF = LO - RF

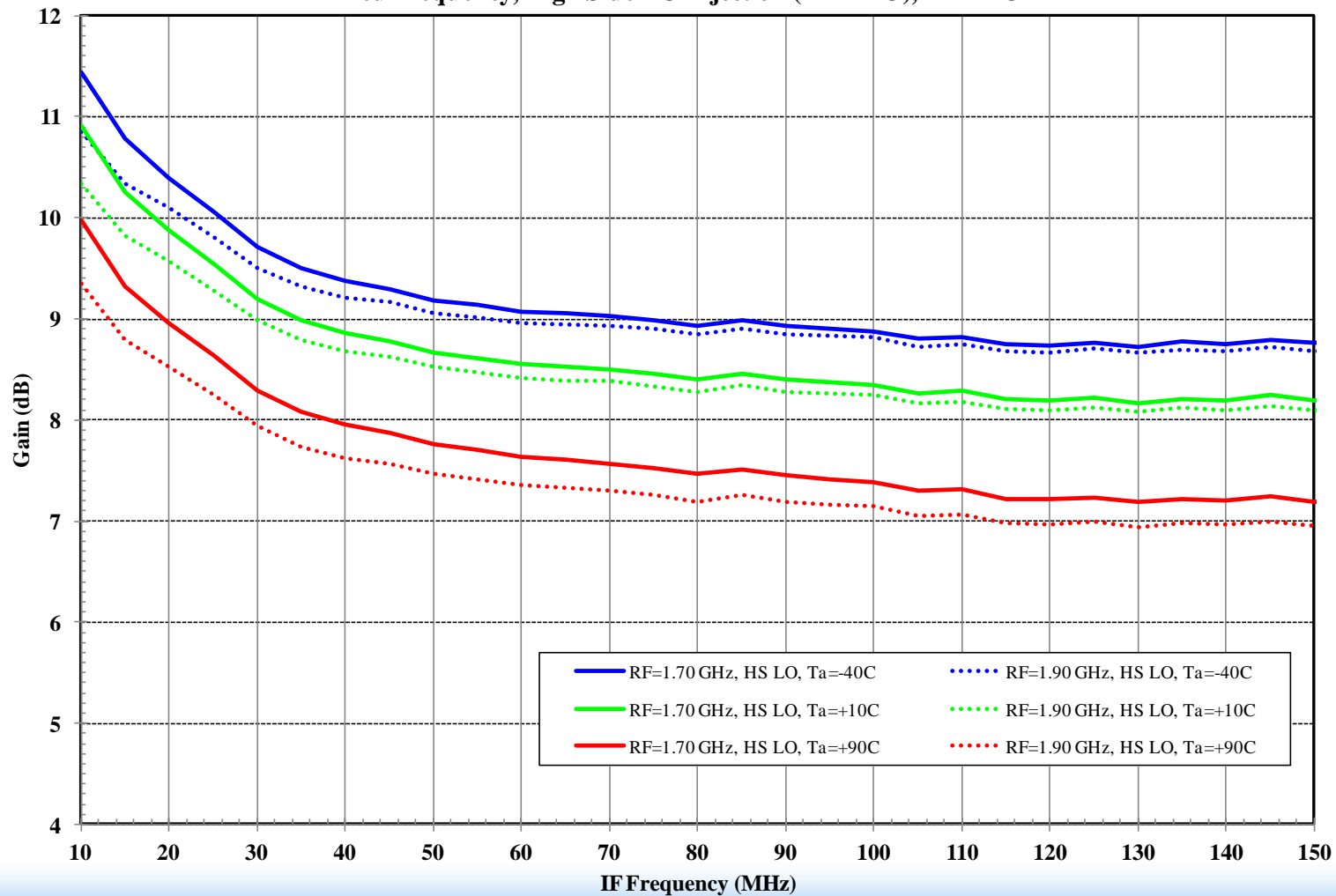

# RF Match – Gain, Low Side LO

F1152 RF to IF Dual Downconverting Mixer  
 $V_{cc-IF} = +3.3\text{ V}$ ,  $V_{cc} = +5.0\text{ V}$ , Low Frequency IF Circuitry, **RF Port Match**  
RF Fixed Frequency, Low Side LO Injection (RF > LO), IF = RF - LO

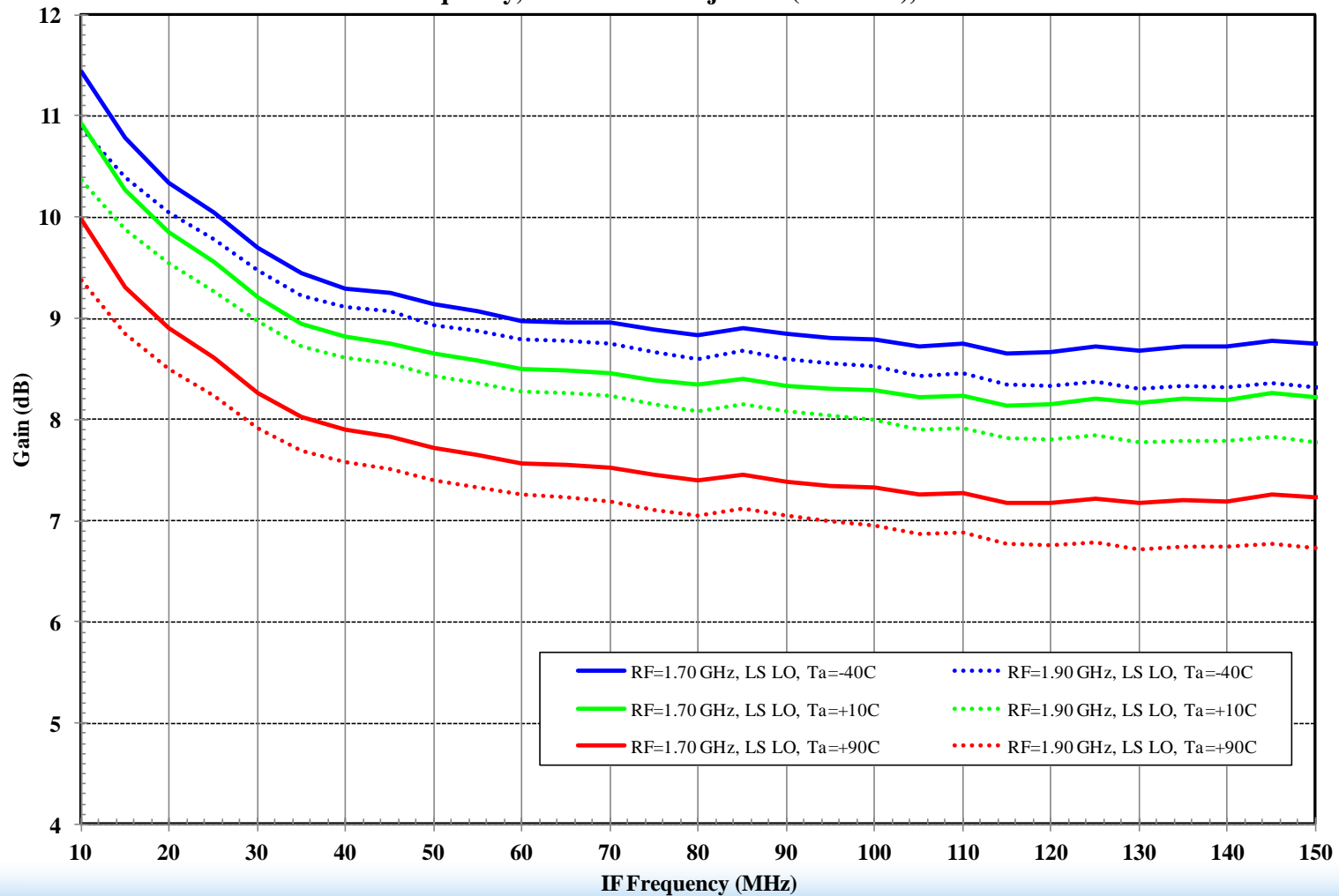

# RF Match – OIP3, High Side LO

F1152 RFto IF Dual Downconverting Mixer  
Vcc-IF= +3.3 V, Vcc = +5.0 V, Low Frequency IF Circuitry, **RF Port Match**  
RF Fixed Frequency, High Side LO Injection (RF < LO), IF = LO - RF

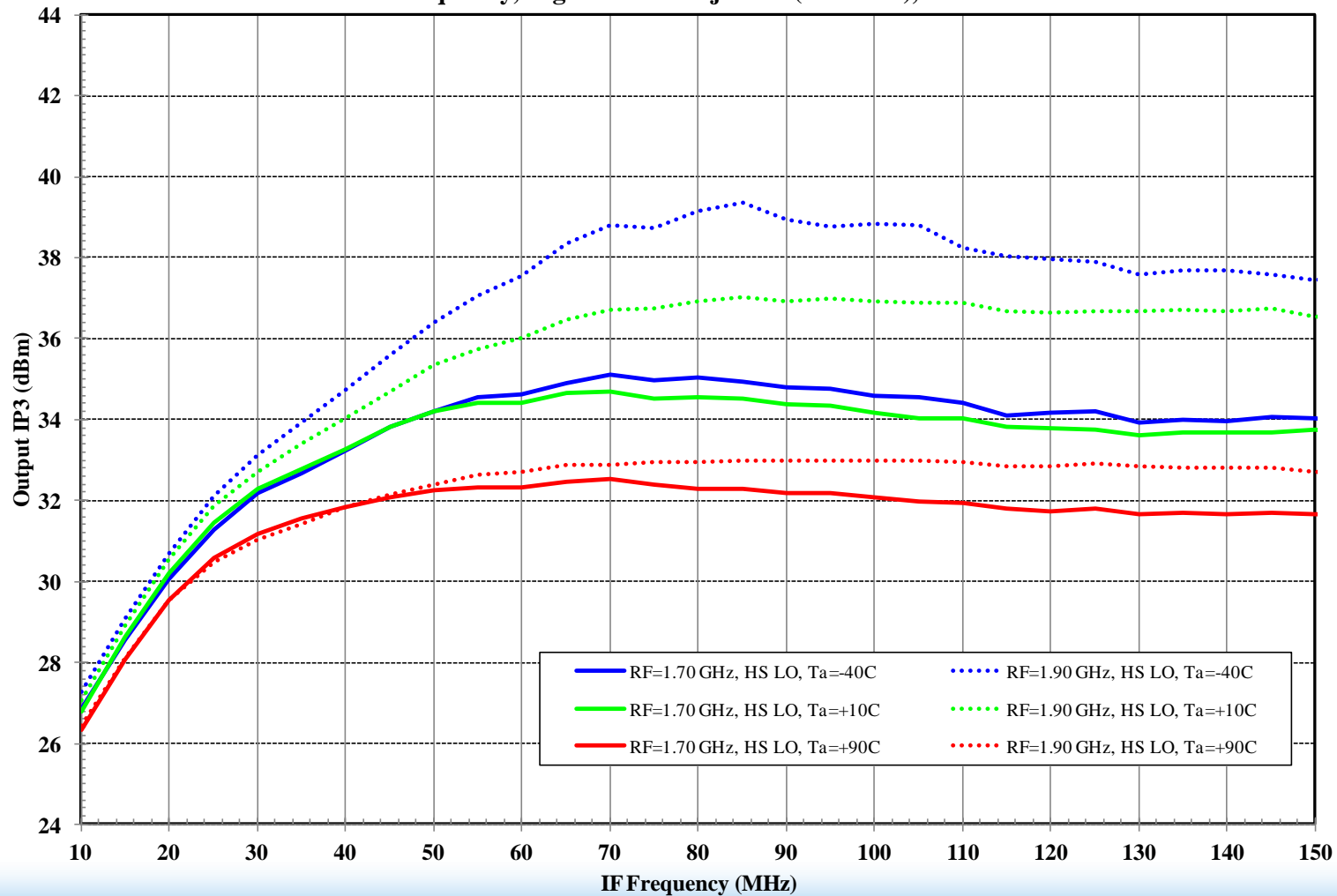

# RF Match – OIP3, Low Side LO

F1152 RFto IF Dual Downconverting Mixer  
 $V_{cc-IF} = +3.3\text{ V}$ ,  $V_{cc} = +5.0\text{ V}$ , Low Frequency IF Circuitry, **RF Port Match**  
RF Fixed Frequency, Low Side LO Injection (RF > LO), IF = RF - LO

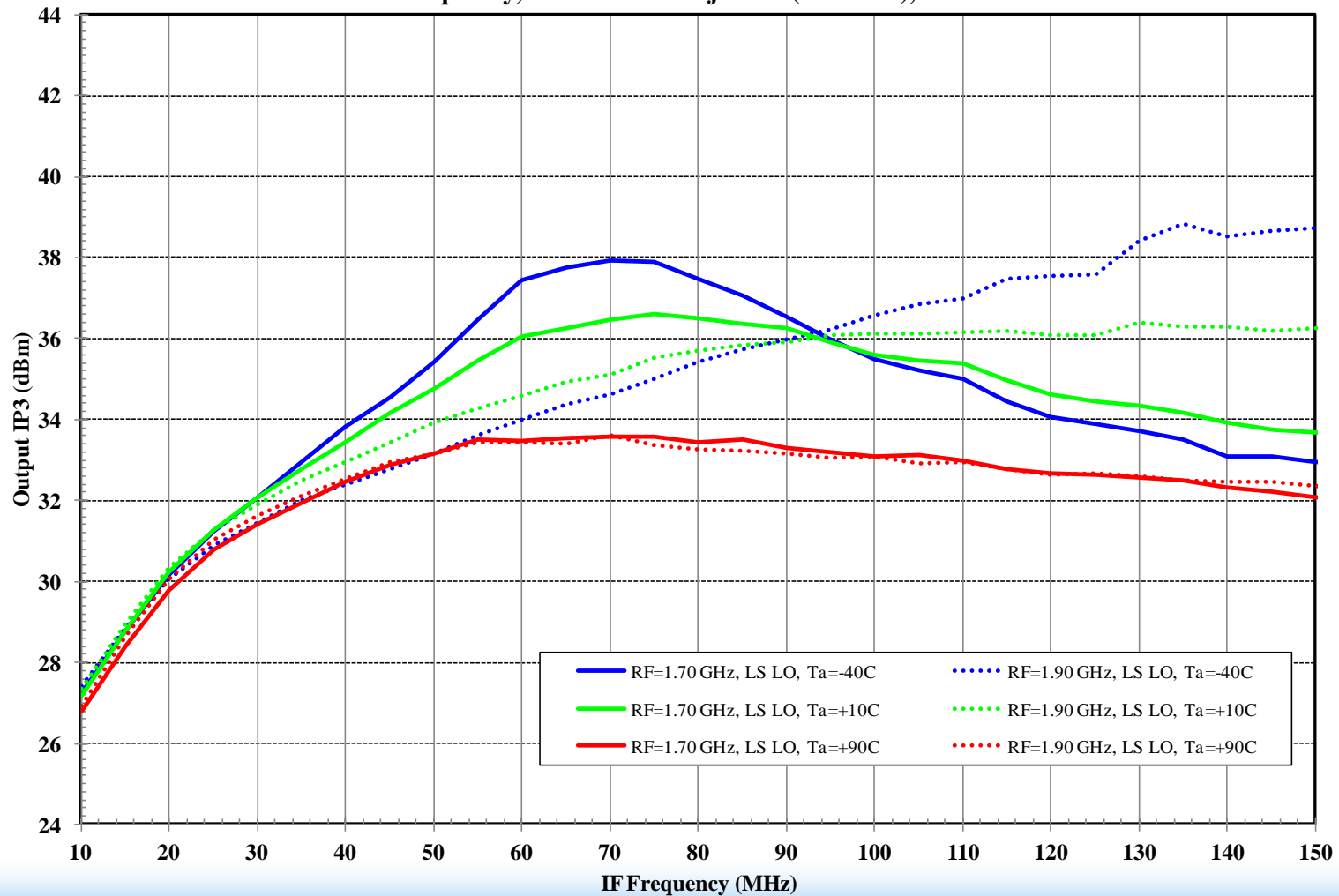

# RF Match – IIP3, High Side LO

F1152 RF to IF Dual Downconverting Mixer  
 $V_{cc-IF} = +3.3\text{ V}$ ,  $V_{cc} = +5.0\text{ V}$ , Low Frequency IF Circuitry, **RF Port Match**  
RF Fixed Frequency, High Side LO Injection ( $RF < LO$ ),  $IF = LO - RF$

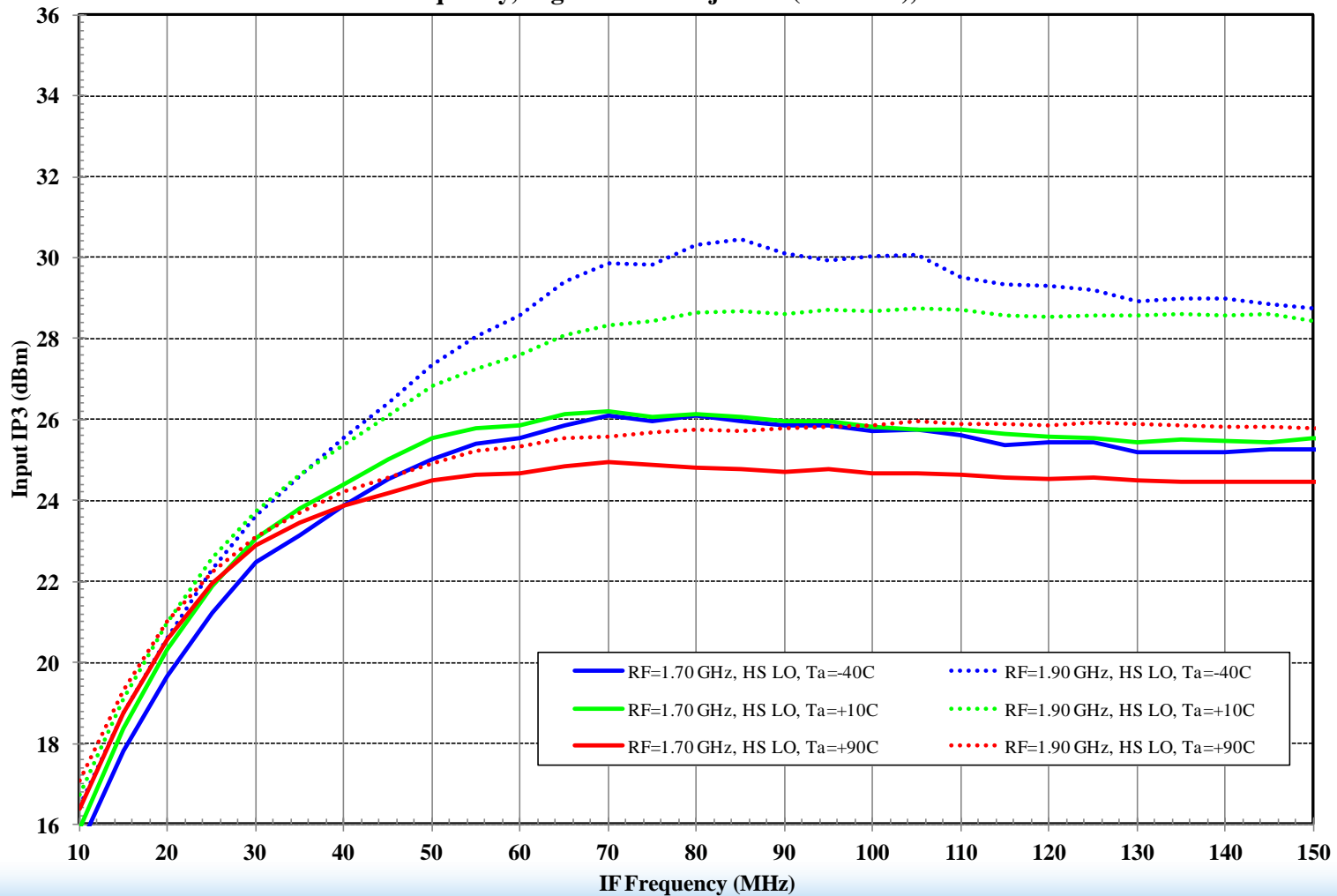

# RF Match – IIP3, Low Side LO

F1152 RF to IF Dual Downconverting Mixer  
 $V_{cc-IF} = +3.3\text{ V}$ ,  $V_{cc} = +5.0\text{ V}$ , Low Frequency IF Circuitry, **RF Port Match**  
RF Fixed Frequency, Low Side LO Injection ( $RF > LO$ ),  $IF = RF - LO$

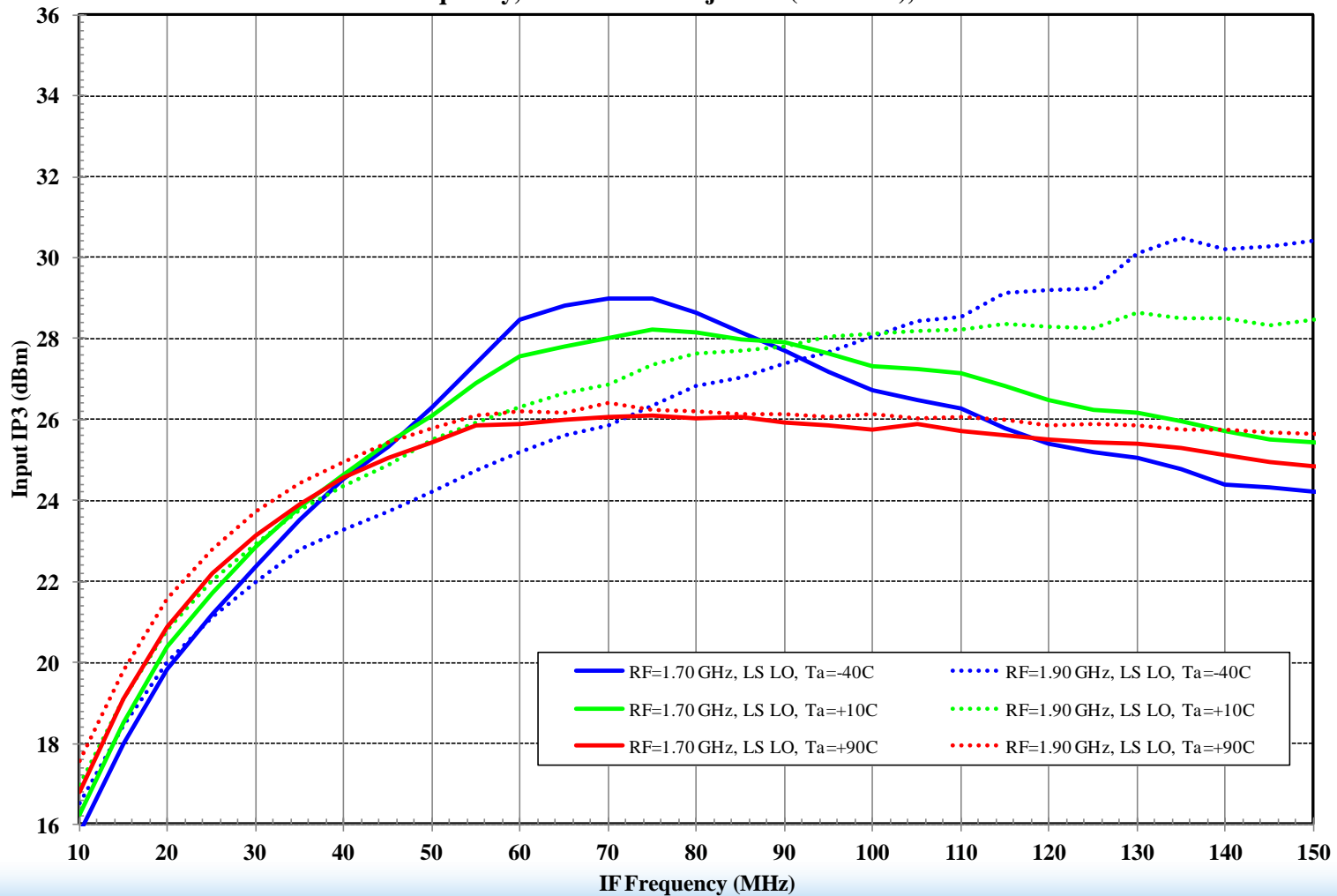

# RF Match – DC Power, High Side LO

F1152 RF to IF Dual Downconverting Mixer  
 $V_{cc-IF} = +3.3\text{ V}$ ,  $V_{cc} = +5.0\text{ V}$ , Low Frequency IF Circuitry, **RF Port Match**  
RF Fixed Frequency, High Side LO Injection ( $RF < LO$ ),  $IF = LO - RF$

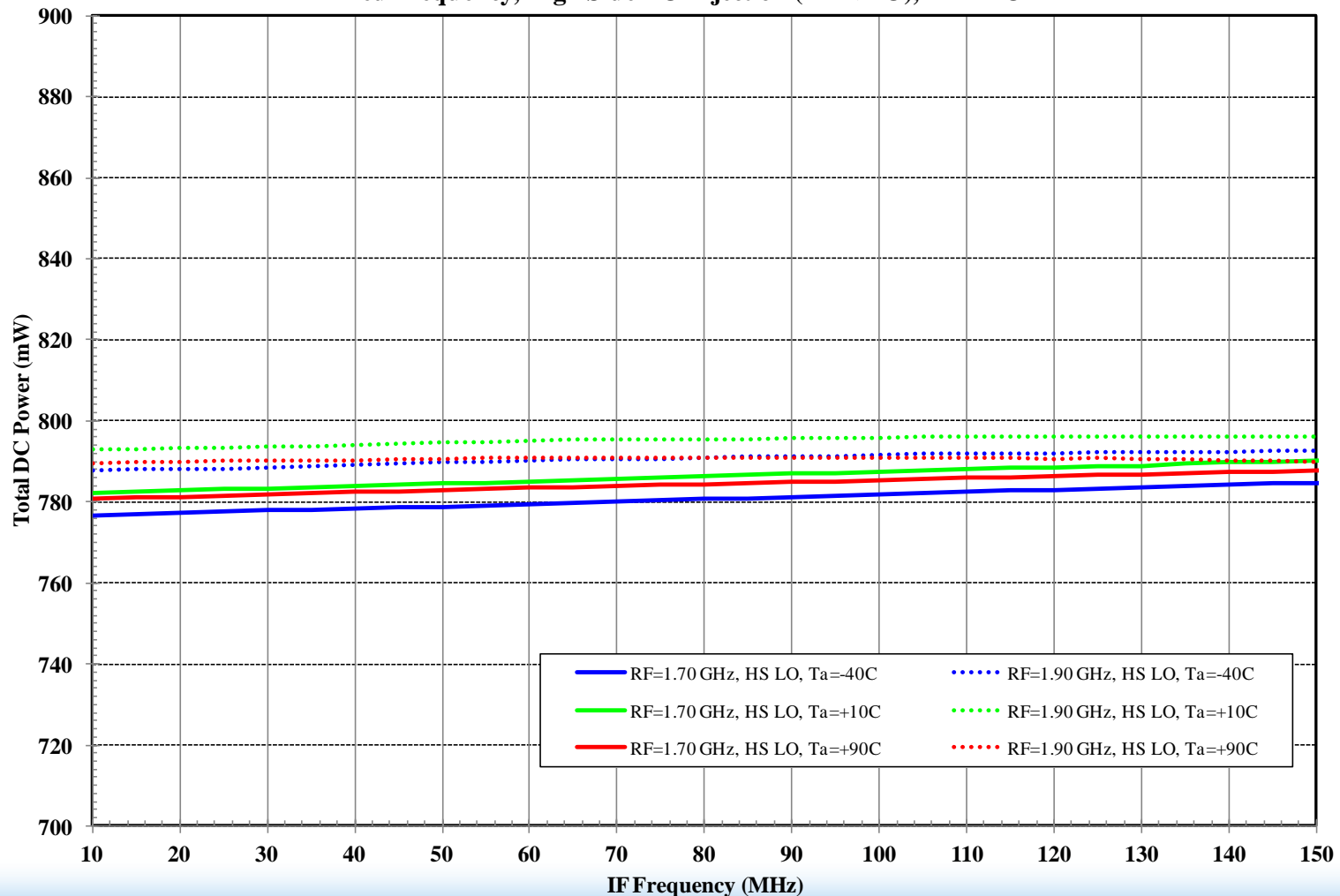

# RF Match – DC Power, Low Side LO

F1152 RF to IF Dual Downconverting Mixer  
 $V_{CC-IF} = +3.3\text{ V}$ ,  $V_{CC} = +5.0\text{ V}$ , Low Frequency IF Circuitry, **RF Port Match**  
RF Fixed Frequency, Low Side LO Injection ( $RF > LO$ ),  $IF = RF - LO$

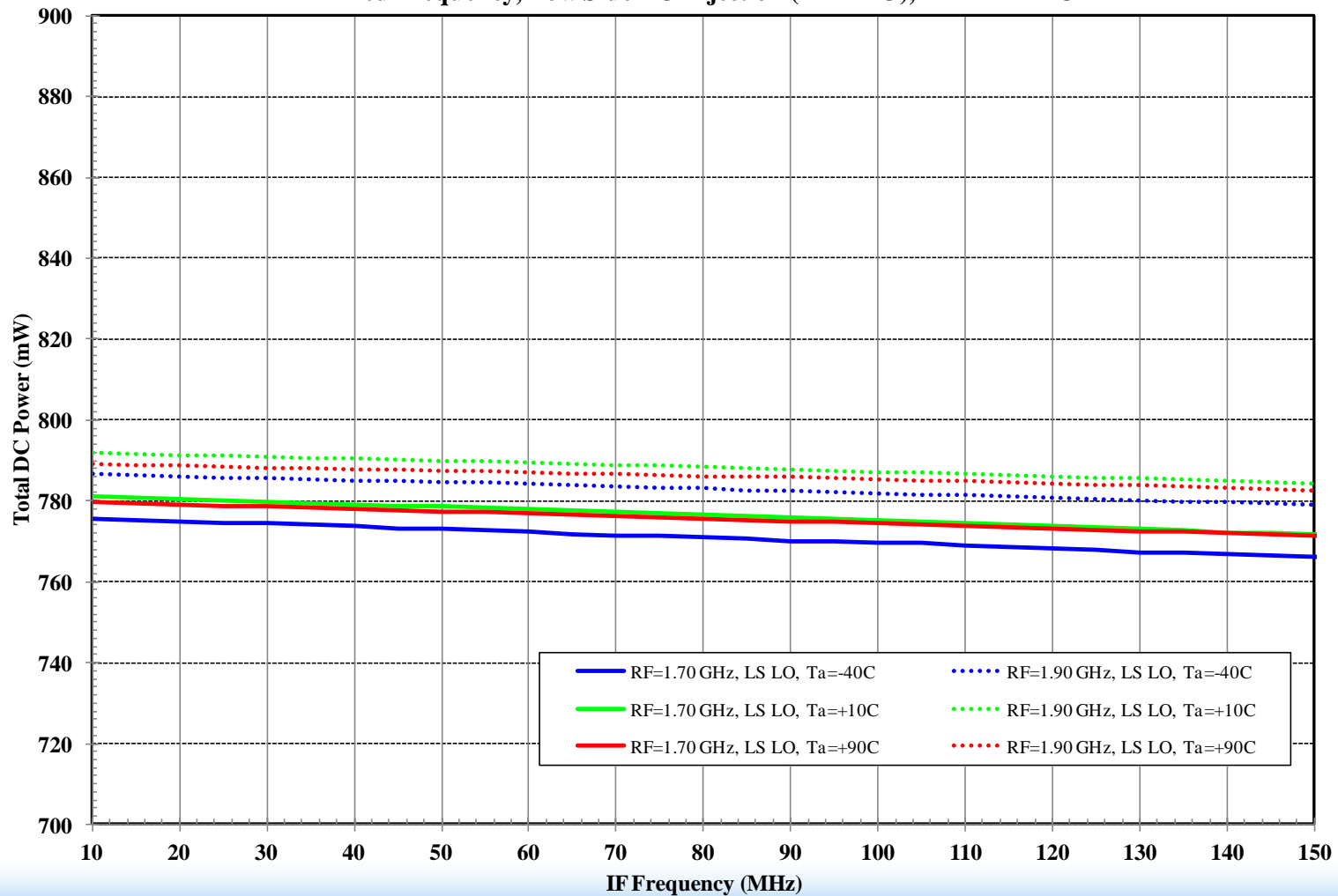



# RF Match – OP1dB, High Side LO

F1152 RFto IF Dual Downconverting Mixer  
Vcc-IF= +3.3 V, Vcc = +5.0 V, Low Frequency IF Circuitry, **RF Port Match**  
RF Fixed Frequency, High Side LO Injection (RF < LO), IF = LO - RF

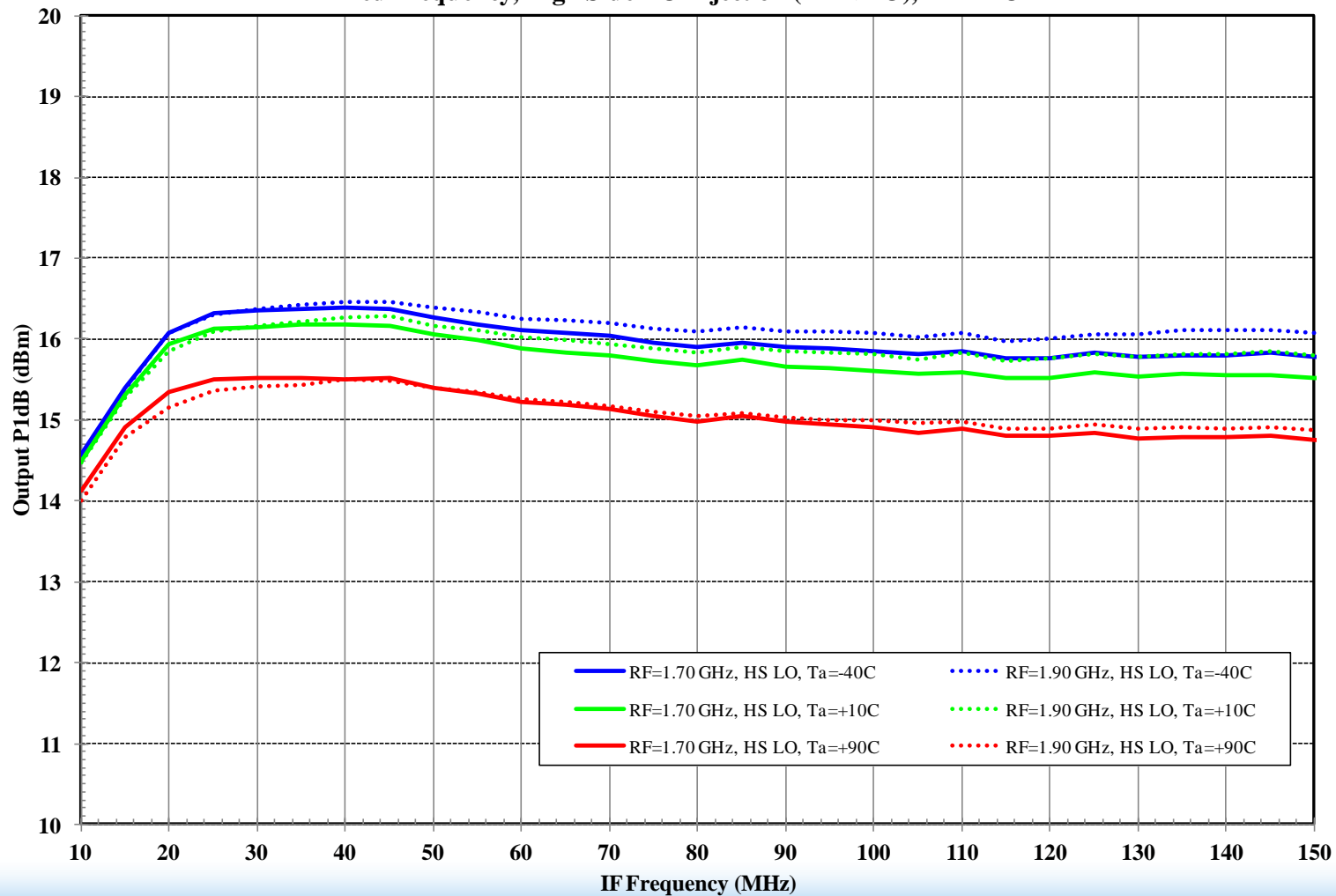

# RF Match – OP1dB, Low Side LO

F1152 RF to IF Dual Downconverting Mixer  
V<sub>cc-IF</sub> = +3.3 V, V<sub>cc</sub> = +5.0 V, Low Frequency IF Circuitry, **RF Port Match**  
RF Fixed Frequency, Low Side LO Injection (RF > LO), IF = RF - LO

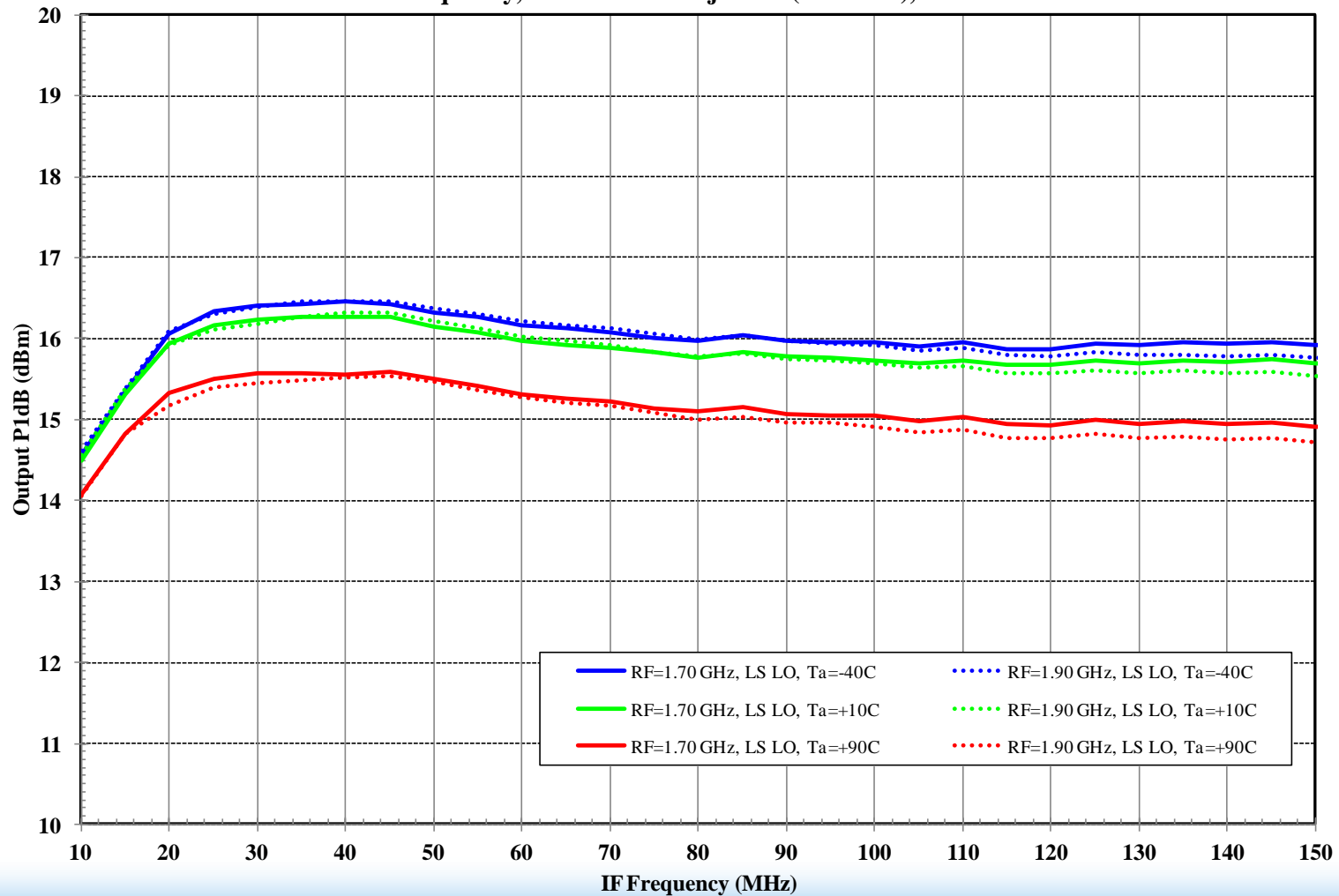

# RF Match – OIP2, High Side LO

F1152 RF to IF Dual Downconverting Mixer  
Vcc-IF = +3.3 V, Vcc = +5.0 V, Low Frequency IF Circuitry, **RF Port Match**  
RF Fixed Frequency, High Side LO Injection (RF < LO), IF = LO - RF

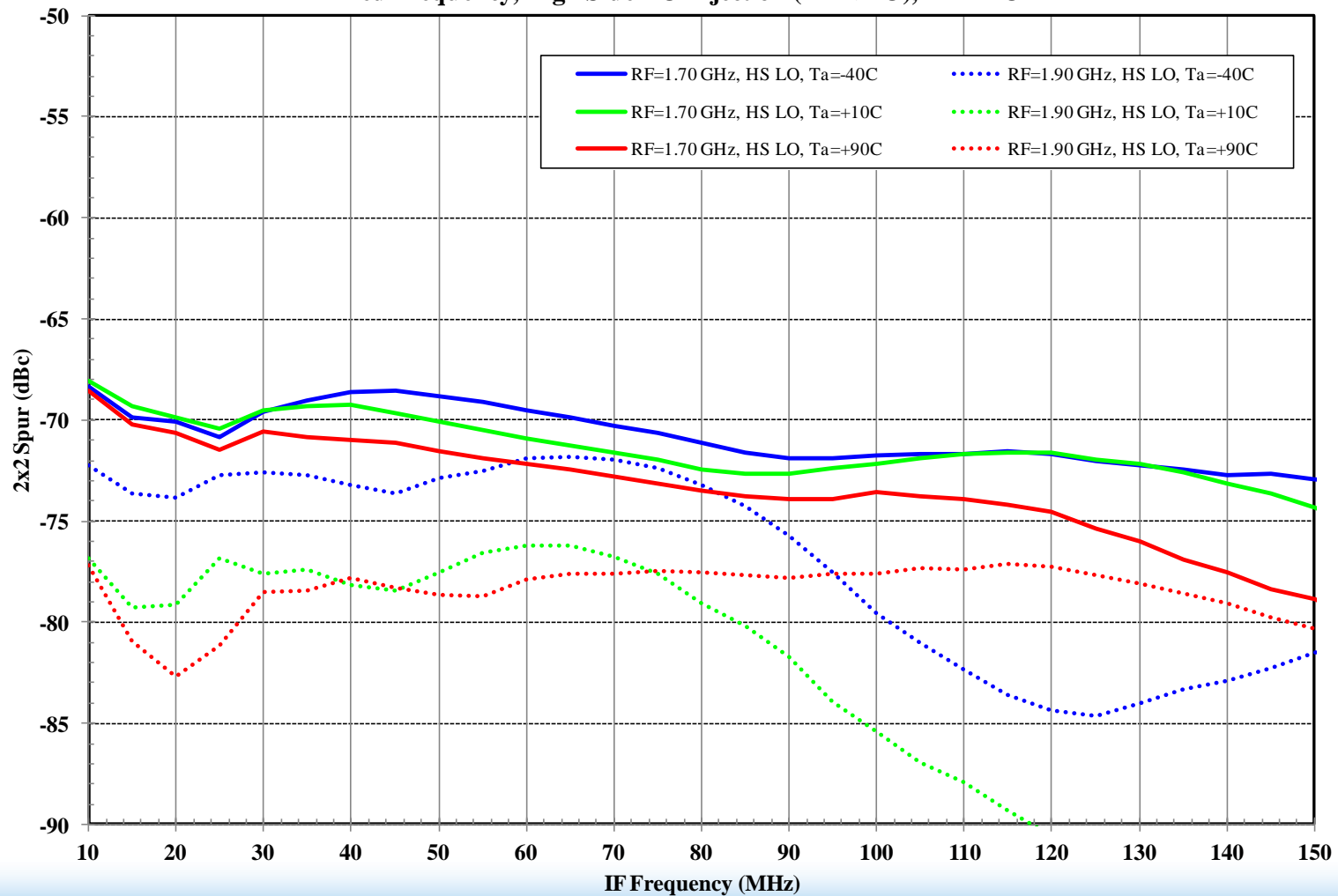

# RF Match – OIP2, Low Side LO

F1152 RFto IF Dual Downconverting Mixer  
Vcc-IF= +3.3 V, Vcc = +5.0 V, Low Frequency IF Circuitry, **RF Port Match**  
RF Fixed Frequency, Low Side LO Injection (RF > LO), IF = RF - LO

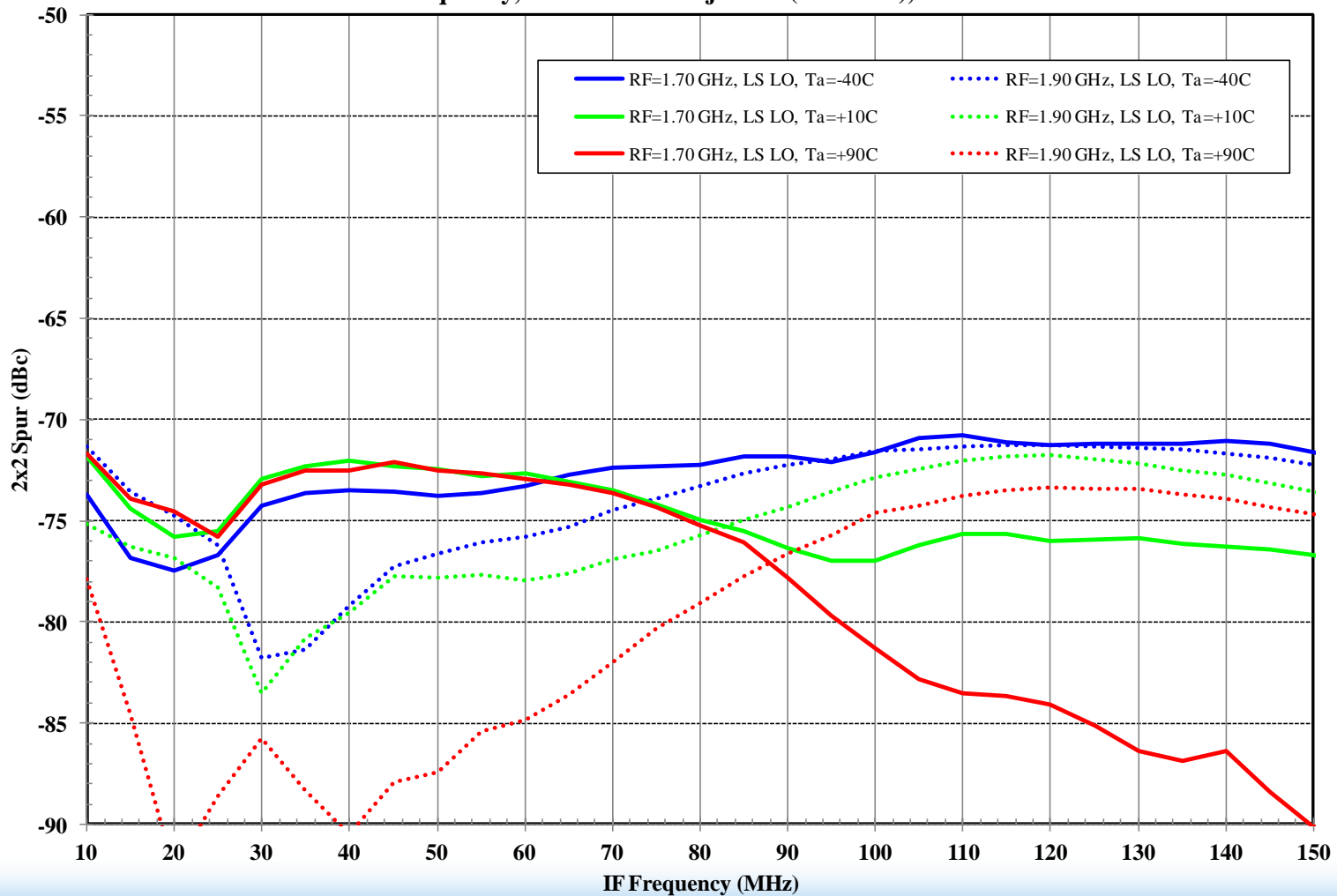

# RF Match – 2x2 Rejection, High Side LO

F1152 RF to IF Dual Downconverting Mixer  
Vcc-IF = +3.3 V, Vcc = +5.0 V, Low Frequency IF Circuitry, **RF Port Match**  
RF Fixed Frequency, High Side LO Injection (RF < LO), IF = LO - RF

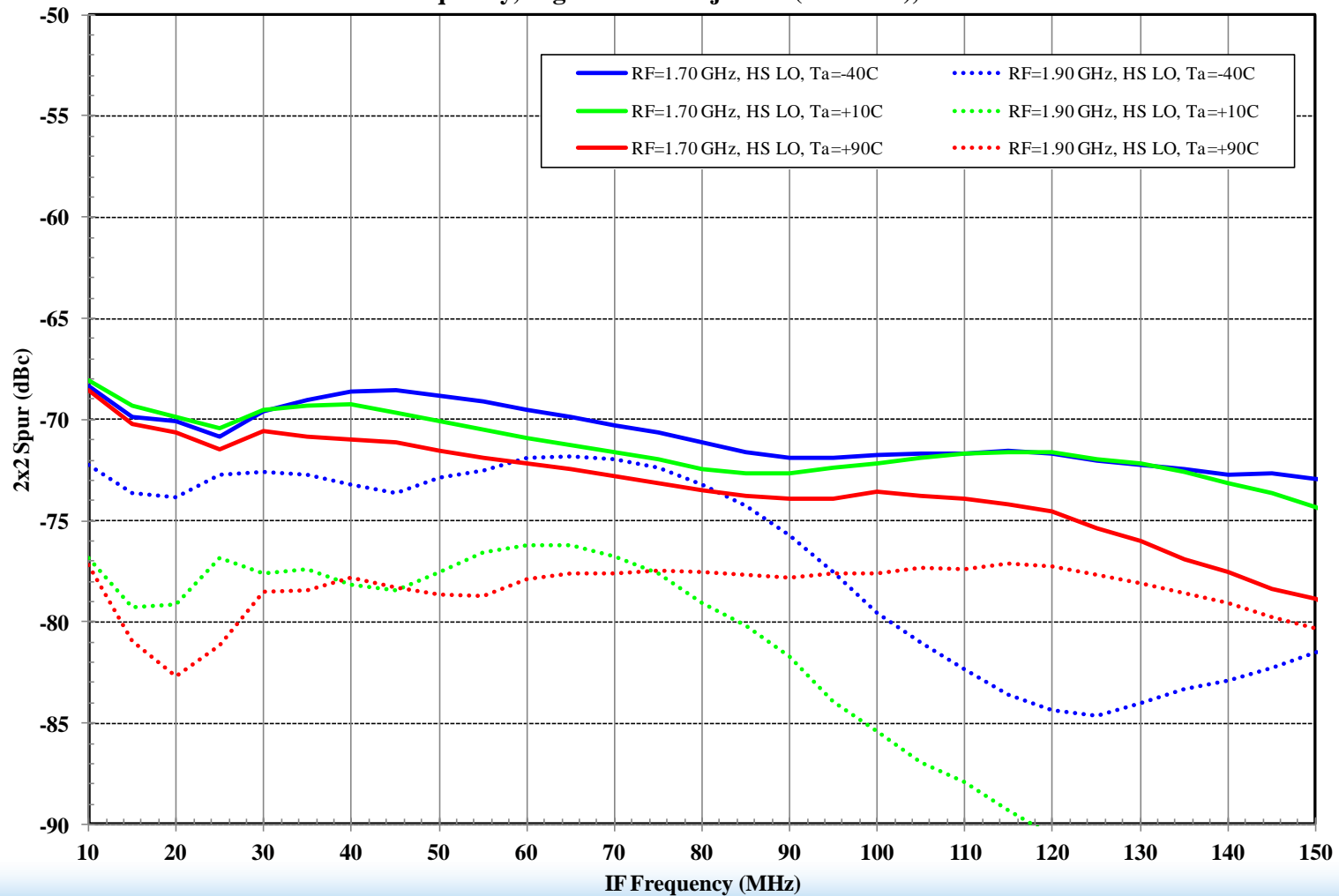

# RF Match – 2x2 Rejection, Low Side LO

F1152 RF to IF Dual Downconverting Mixer  
V<sub>cc-IF</sub> = +3.3 V, V<sub>cc</sub> = +5.0 V, Low Frequency IF Circuitry, **RF Port Match**  
RF Fixed Frequency, Low Side LO Injection (RF > LO), IF = RF - LO

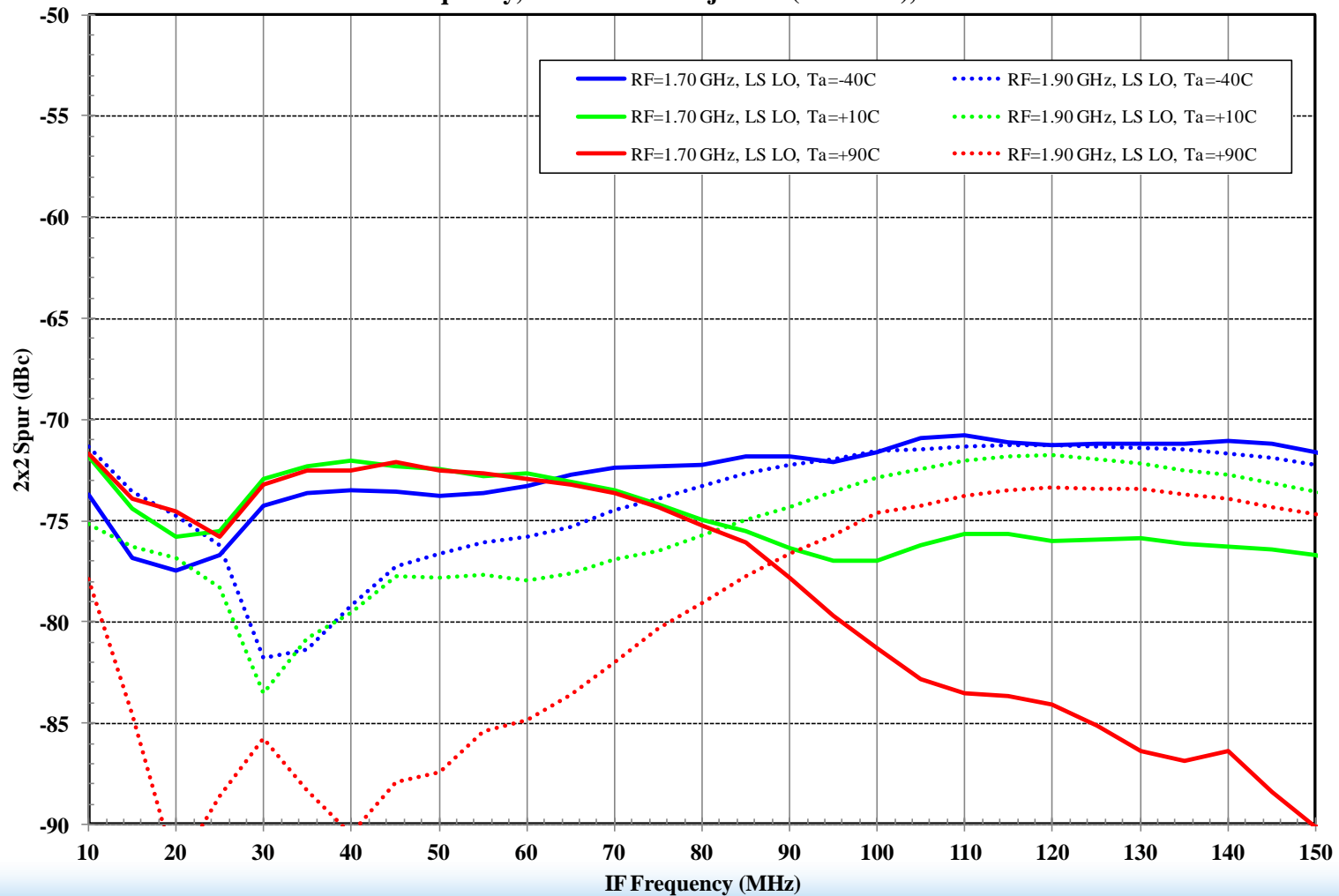

# RF Match – 3x3 Rejection, High Side LO

F1152 RF to IF Dual Downconverting Mixer  
Vcc-IF= +3.3 V, Vcc = +5.0 V, Low Frequency IF Circuitry, **RF Port Match**  
RF Fixed Frequency, High Side LO Injection (RF < LO), IF = LO - RF

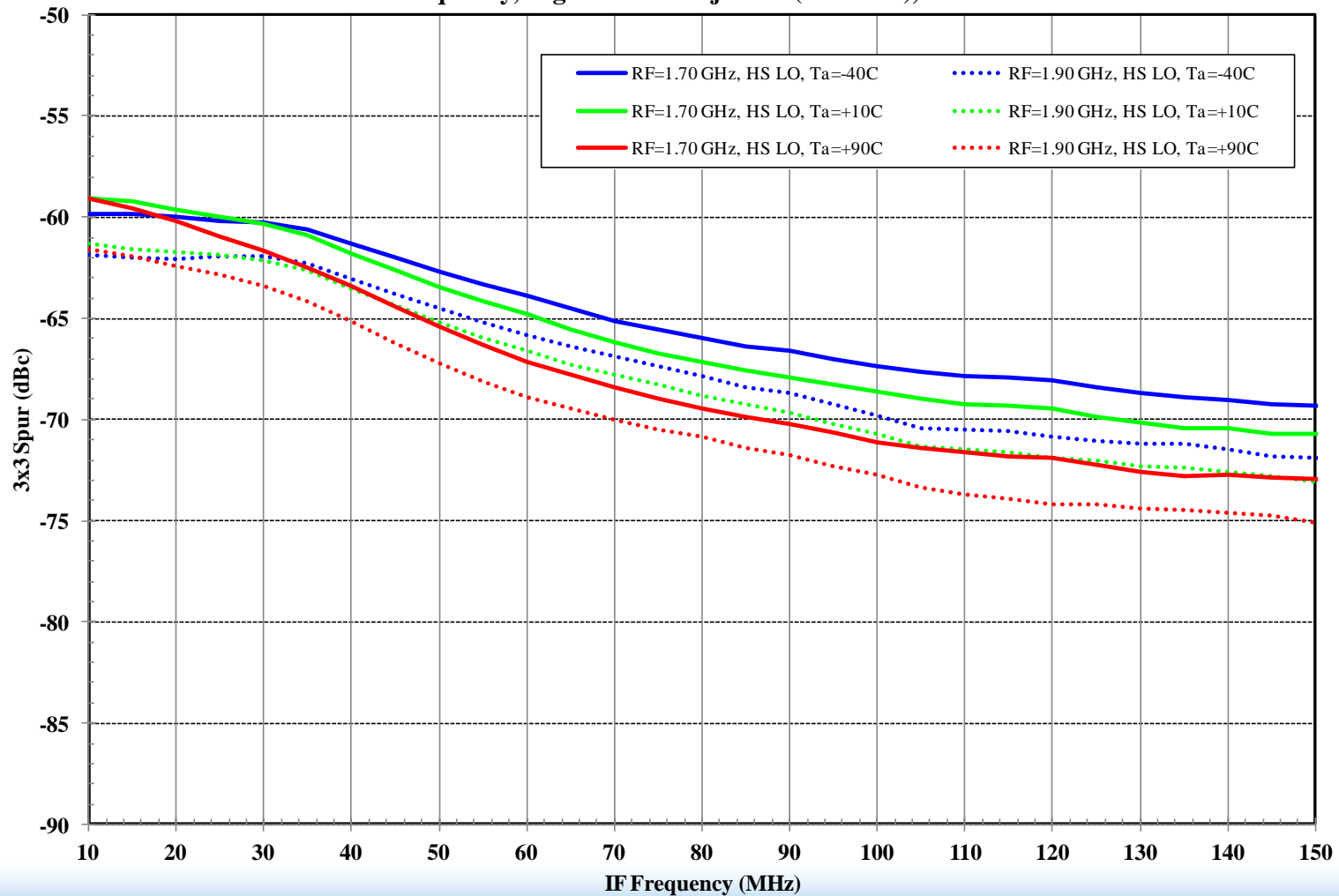

# RF Match– 3x3 Rejection, Low Side LO

F1152 RF to IF Dual Downconverting Mixer  
V<sub>cc-IF</sub> = +3.3 V, V<sub>cc</sub> = +5.0 V, Low Frequency IF Circuitry, **RF Port Match**  
RF Fixed Frequency, Low Side LO Injection (RF > LO), IF = RF - LO

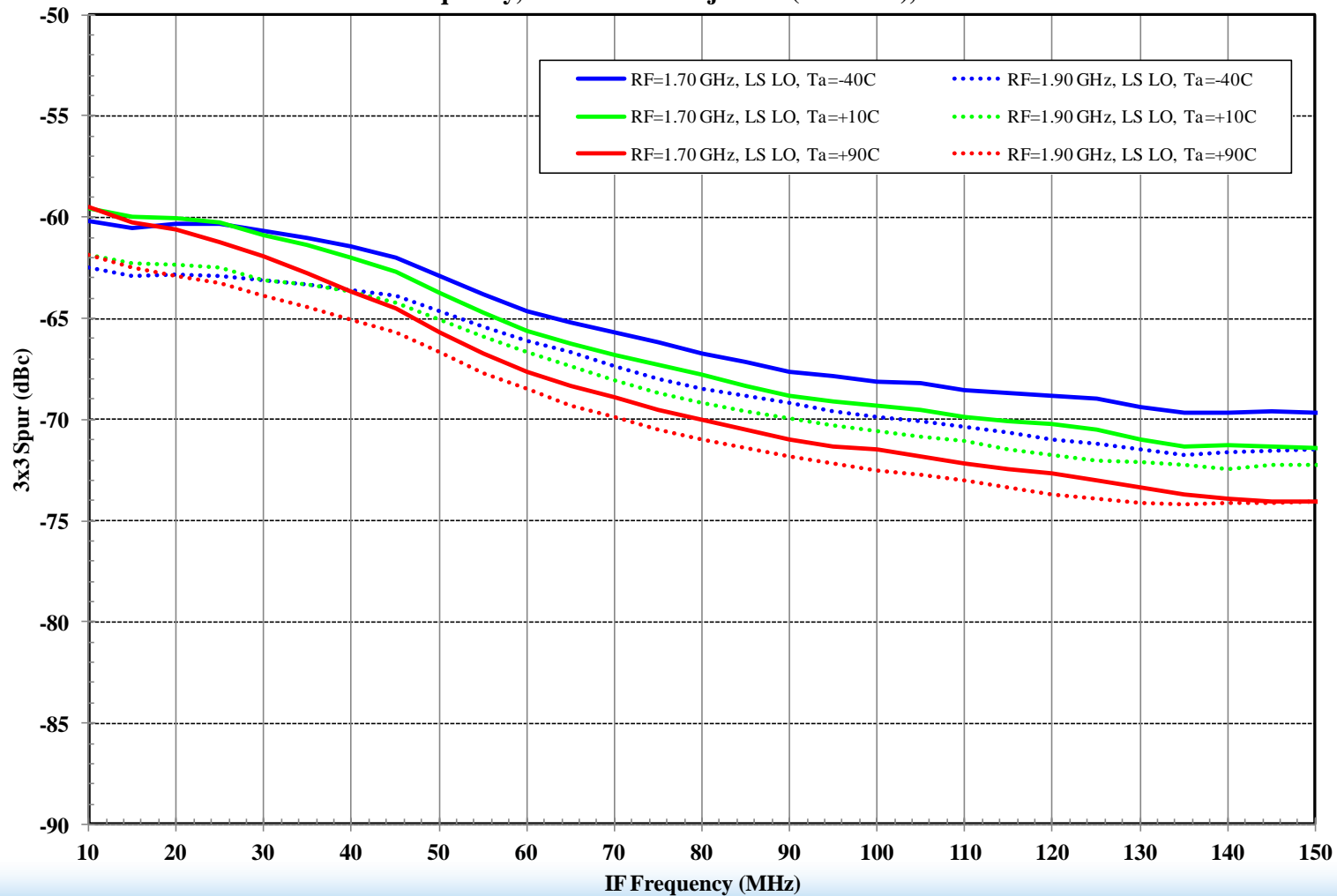



# IF Circuit Modifications

- Customer modified the IF circuit to move the balanced circuitry to the other side of the balun.
- This modification could not be done because
  - It assumes a balanced configuration and IDT's evaluation board is single-ended.
  - There is not enough room between the balun and evaluation board connector to place the elements.

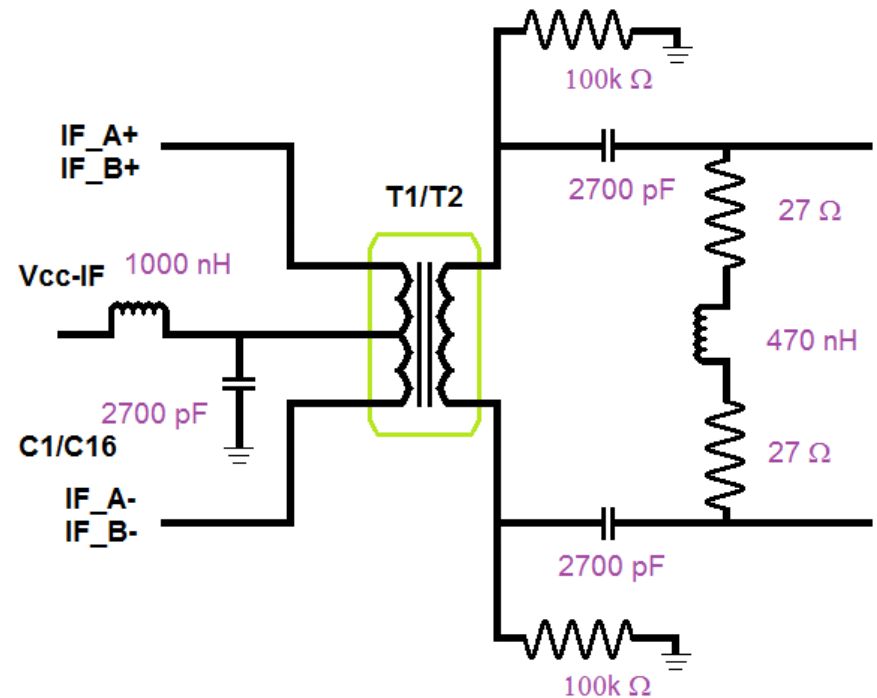

# Comparison – Gain

**F1152 RF to IF Dual Downconverting Mixer**  
**V<sub>cc-IF</sub> = +3.3 V, V<sub>cc</sub> = +5.0 V, RF Fixed Frequency,**  
**Comparison of the Gain at Room Temperature**

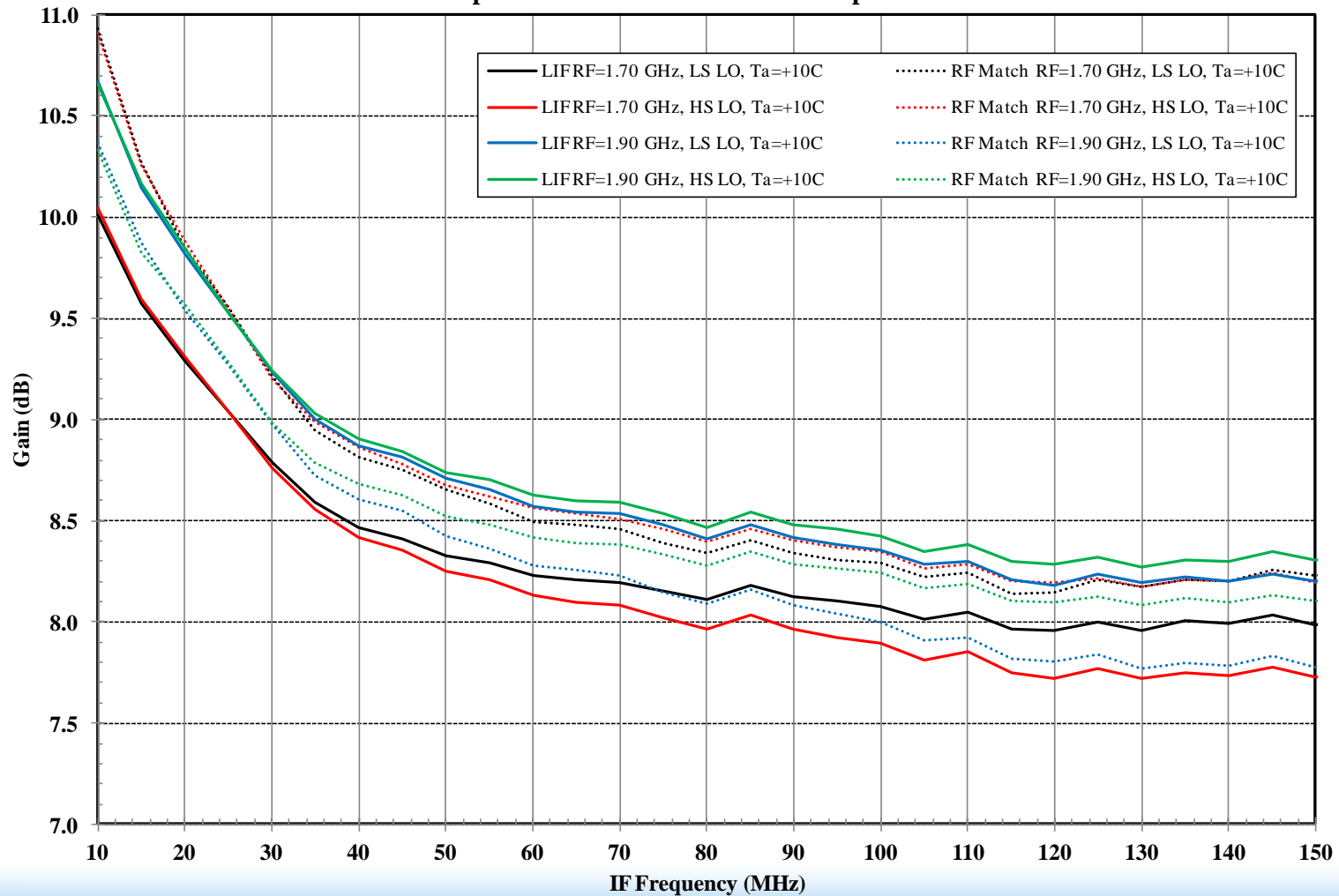

# Comparison – OIP3

**F1152 RF to IF Dual Downconverting Mixer**  
**V<sub>cc-IF</sub> = +3.3 V, V<sub>cc</sub> = +5.0 V, RF Fixed Frequency,**  
**Comparison of the Output IP3 at Room Temperature**

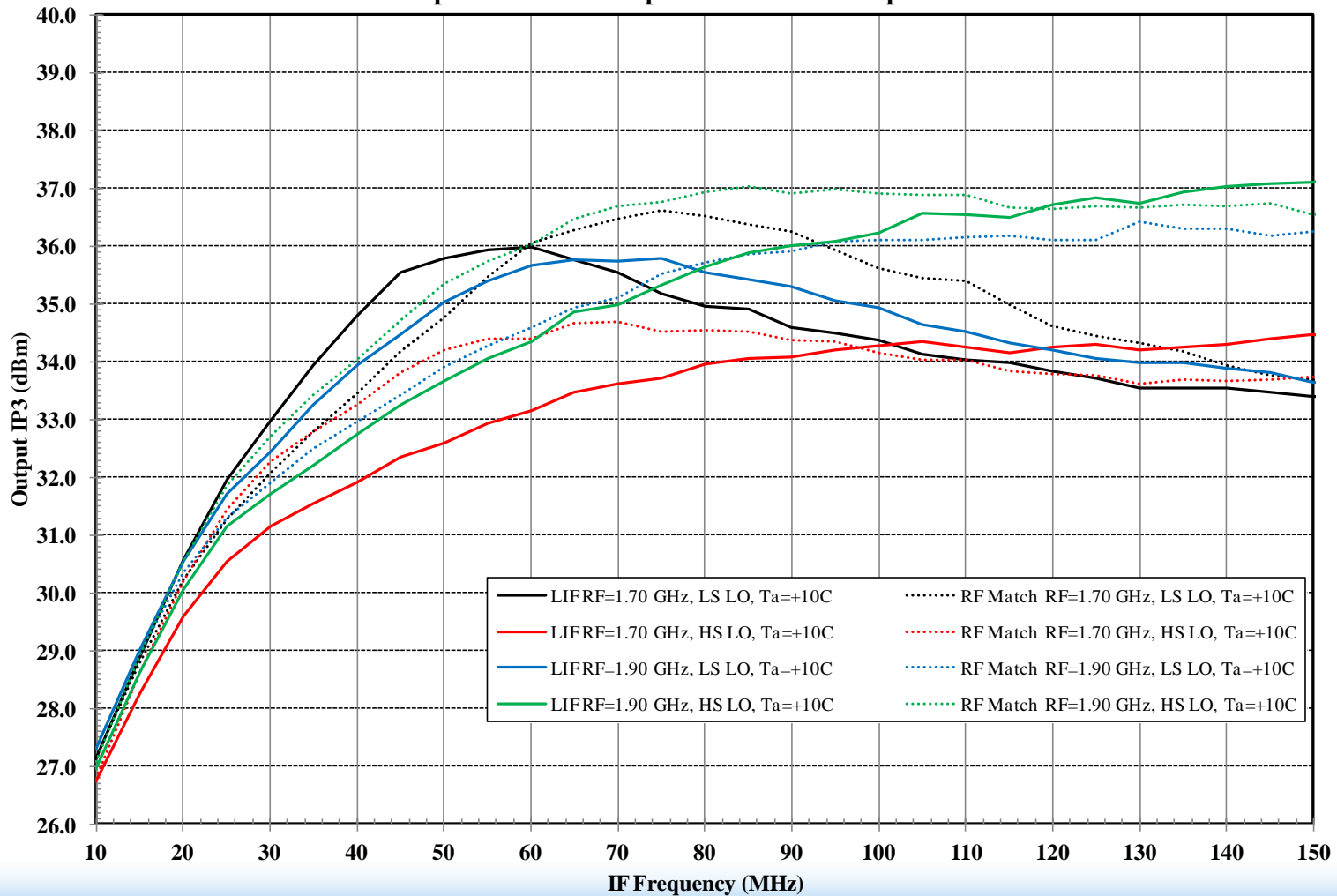

# Comparison – OP1dB

F1152 RF to IF Dual Downconverting Mixer  
Vcc-IF= +3.3 V, Vcc = +5.0 V, RF Fixed Frequency,  
Comparison of the Output P1dB at Room Temperature

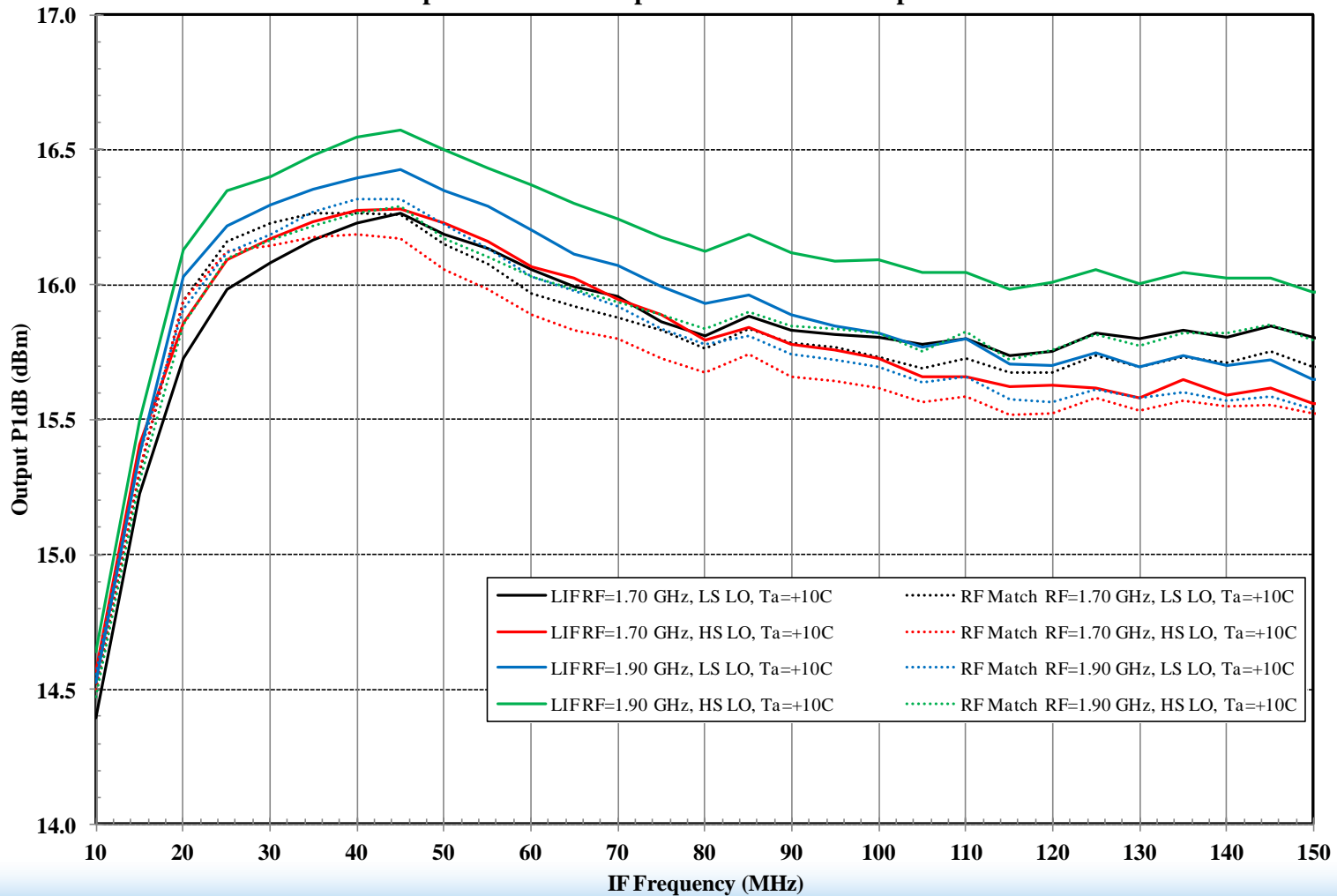

# RF Match – Measurement Parameters

- The measurements were done exactly the same as the Low IF circuitry testing



# Conclusion

- As compared to the 2013 report, the data is very similar and within process variation.
- The electrical performance is similar for both low and high side LO injection.
- The RF Match had the following affect:
  - Gain increase at 1.7 GHz and decrease at 1.9 GHz. It was less than 0.25 dB.
  - OIP3 was the same or increased.
  - OP1dB decreased by less than 0.25 dB.
- The RF matching circuit does not have significant effect on the downconverter electrical performance.

