

SECTION "X-X"  
TRAY STACKING DETAIL  
SCALE : 3/1

SECTION "Y-Y"

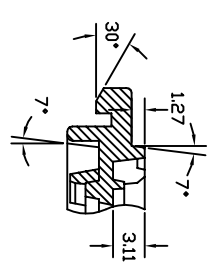

DETAIL "H"  
SCALE : 4/1

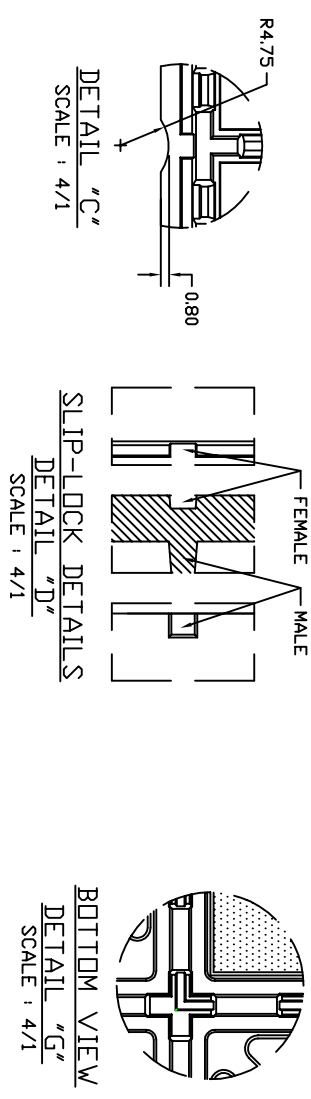

DETAIL "C"  
SCALE : 4/1

SLIP-LOCK DETAILS  
DETAIL "D"  
SCALE : 4/1

BOTTOM VIEW  
DETAIL "G"  
SCALE : 4/1

NOTES : (UNLESS OTHERWISE SPECIFIED)  
1. NUMBER OF POCKET : 5 X 12 = 60 POCKETS

TOLERANCES UNLESS OTHERWISE SPECIFIED		ANGLE	
X ± .10		XX ± .10	
APPROVALS	DATE	WWW.IDT.COM	
DRAWN		6024 Silver Creek Valley Road, San Jose, CA 95138 PHONE: (408) 284-8200 FAX: (408) 284-3572	
TITLE:		BC/BCG/BL/BLG/BR 484, BX/BXG 288 & HL/HLG 484 SHIPPING TRAY	
STOCK NO.	N/A	DRAWING NO.	MSC-5719-A
DO NOT SCALE DRAWING		REV	00
		SCALE	N/A
		SIZE	00
		SHEET	1 OF 2

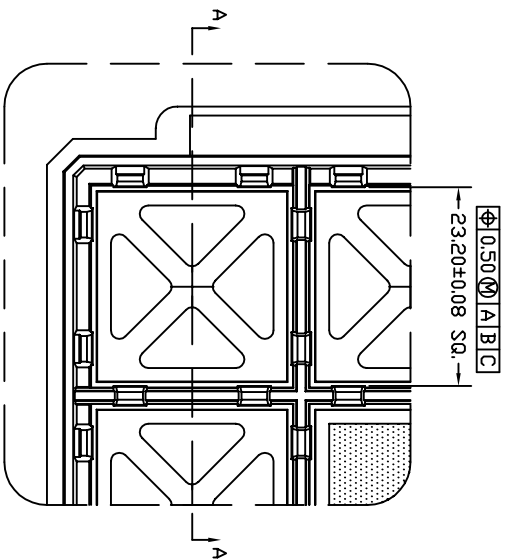

TOP VIEW  
DETAIL "B"  
SCALE : 3/1  
(FROM SHT.#1)

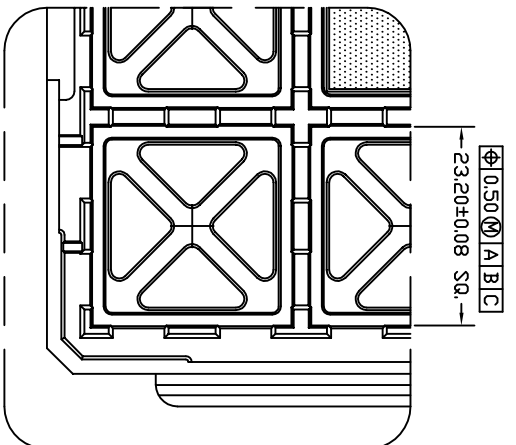

BOTTOM VIEW  
DETAIL "B"  
SCALE : 3/1  
(FROM SHT.#1)

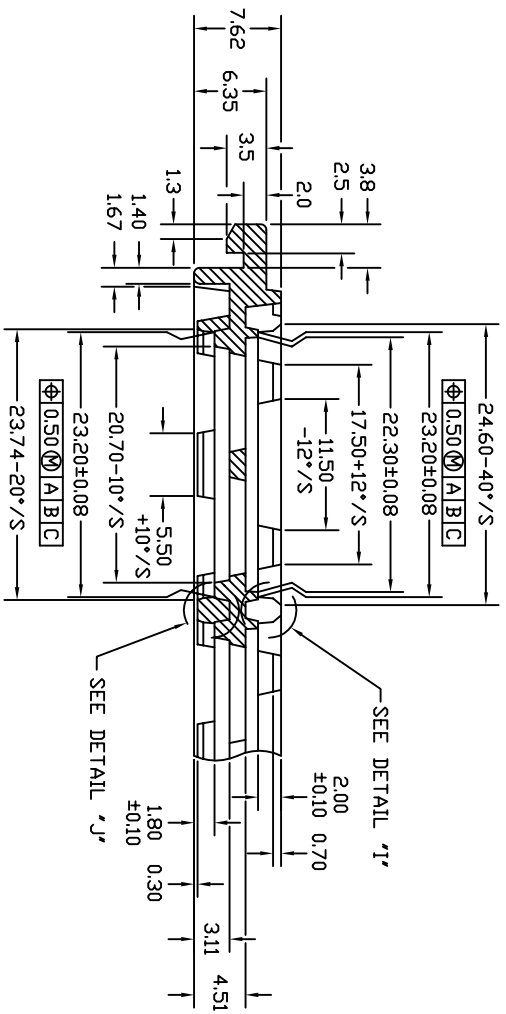

SECTION "A-A"  
SCALE : 4/1

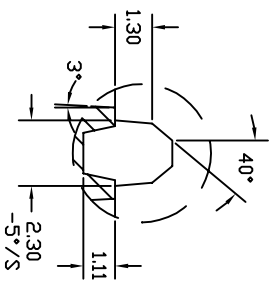

DETAIL "I"  
SCALE : 10/1

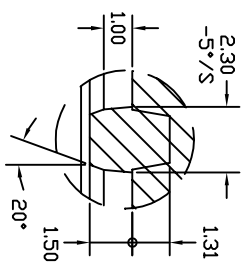

DETAIL "J"  
SCALE : 10/1

TOLERANCES UNLESS OTHERWISE SPECIFIED  
DECIMAL  
X ± .10  
XX ± .10  
ANGLE



6024 Silver Creek Valley Road,  
San Jose, CA 95138  
PHONE: (408) 284-8200  
FAX: (408) 284-3572

APPROVALS  
DATE

TITLE:  
BC/BCG/BL/BLG/BR 484, BX/BXG  
288 & HL/HLG 484 SHIPPING TRAY

STOCK NO.  
N/A

DRAWING NO.  
MSC-5719-A

DO NOT SCALE DRAWING  
SHEET 2 OF 2