

NOTES : (UNLESS OTHERWISE SPECIFIED)
 1. NUMBER OF POCKET : 10 X 26 = 24 POCKETS

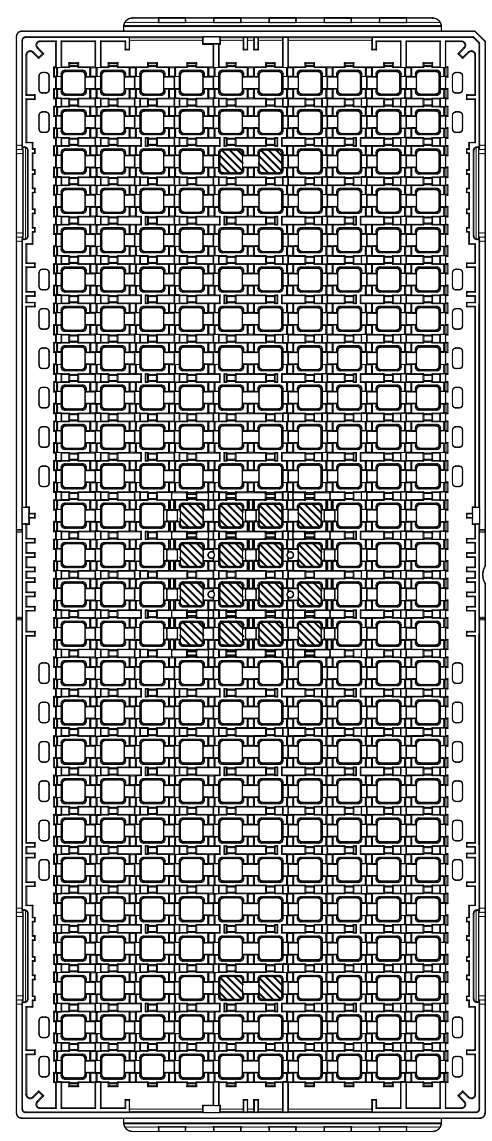

TOLERANCES UNLESS OTHERWISE SPECIFIED		DECIMAL		ANGLE	
.XX ± .25		.XX ± .13		± .5°	
APPROVALS		DATE		SCALE	
DRAWN		DATE		N/A	
KK Three		29 FEB 16		N/A	
TITLE:		WWW.IDT.COM		REV	
BY/BVG 160 SHIPPING TRAY		6024 Silver Creek Valley Road		00	
STOCK NO.		San Jose, CA 95138		00	
N/A		PHONE: (408) 284-8200		00	
DRAWING NO.		FAX: (408) 284-3572		00	
MSC-7743-A				00	
DO NOT SCALE DRAWING		SHEET 1 OF 3			

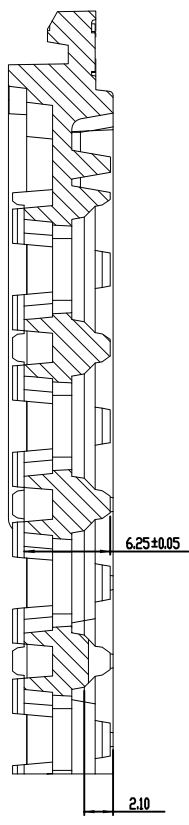
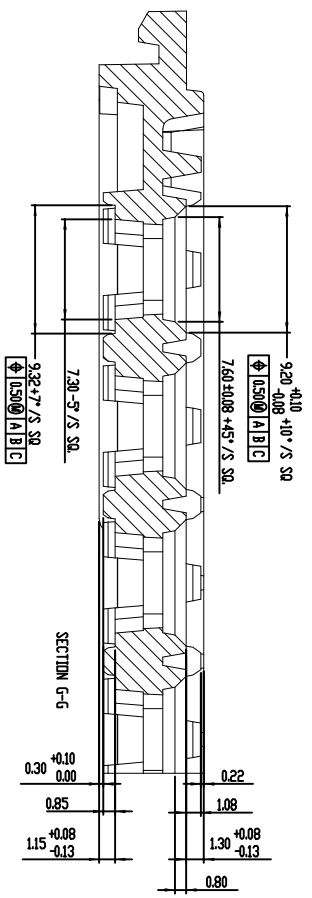
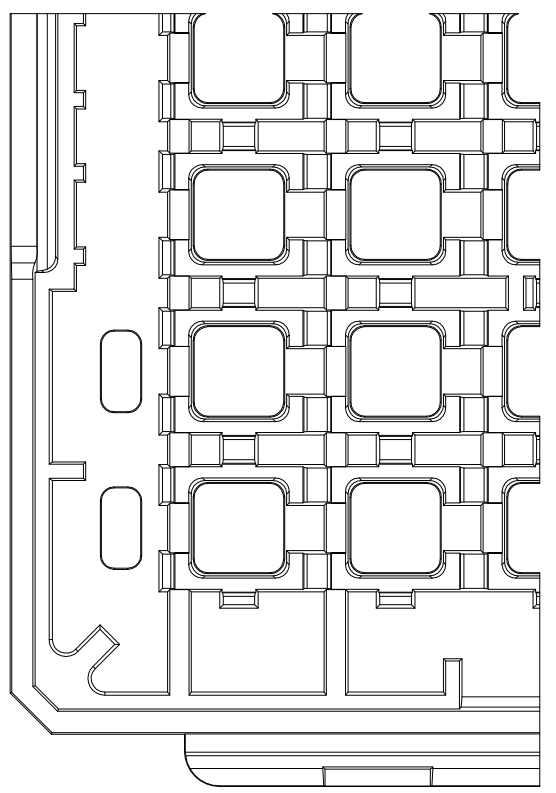
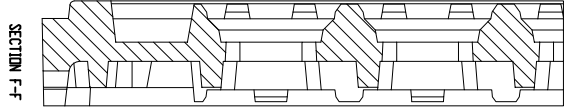
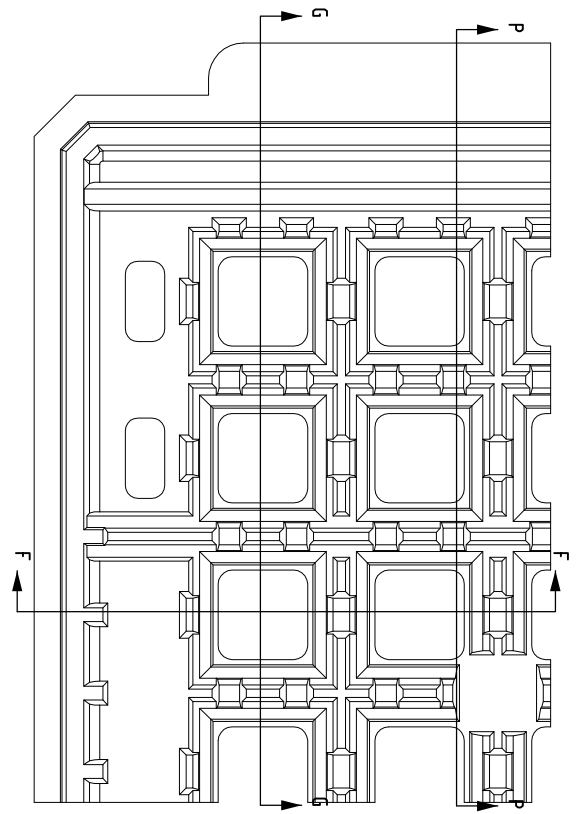

SECTION F-F

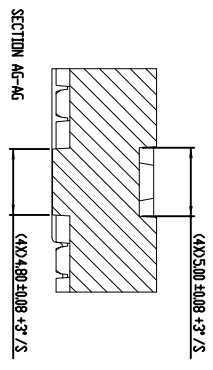
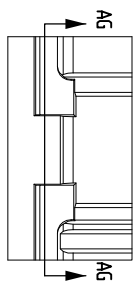

SECTION AG-AG

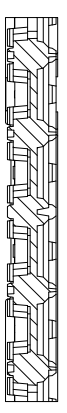
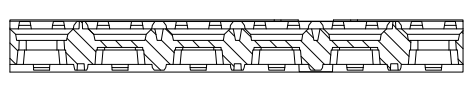
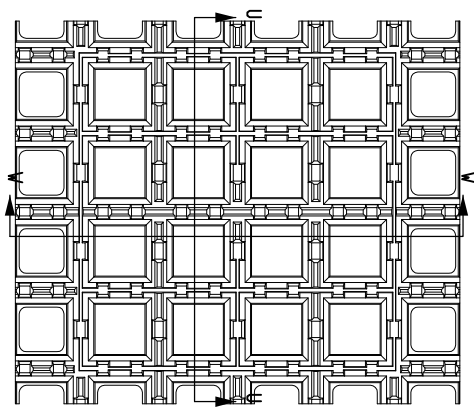

SECTION U-U
SCALE 2:1

SECTION V-V
SCALE 2:1

TOLERANCES UNLESS OTHERWISE SPECIFIED		SCALE	
DECIMAL	±.25	N/A	
.XX	±.13	SIZE	N/A
.XXX	±.13	REV	00
APPROVALS	DATE	DO NOT SCALE DRAWING SHEET 2 OF 3	
DRAWN	29 FEB 16		
			
www.IDT.com			
6024 Silver Creek Valley Road, San Jose, CA 95138			
PHONE: (408) 284-8200			
FAX: (408) 284-3572			
TITLE: BV/BVG 160 SHIPPING TRAY			
STOCK NO.	DRAWING NO.		
N/A	MSC-7743-A		

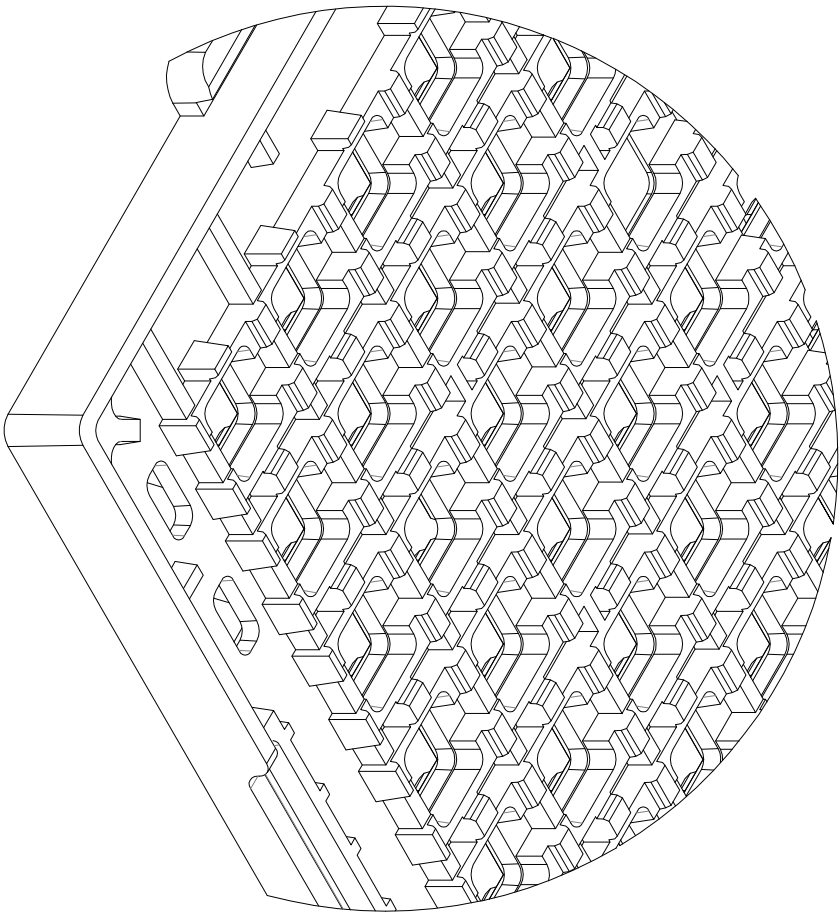
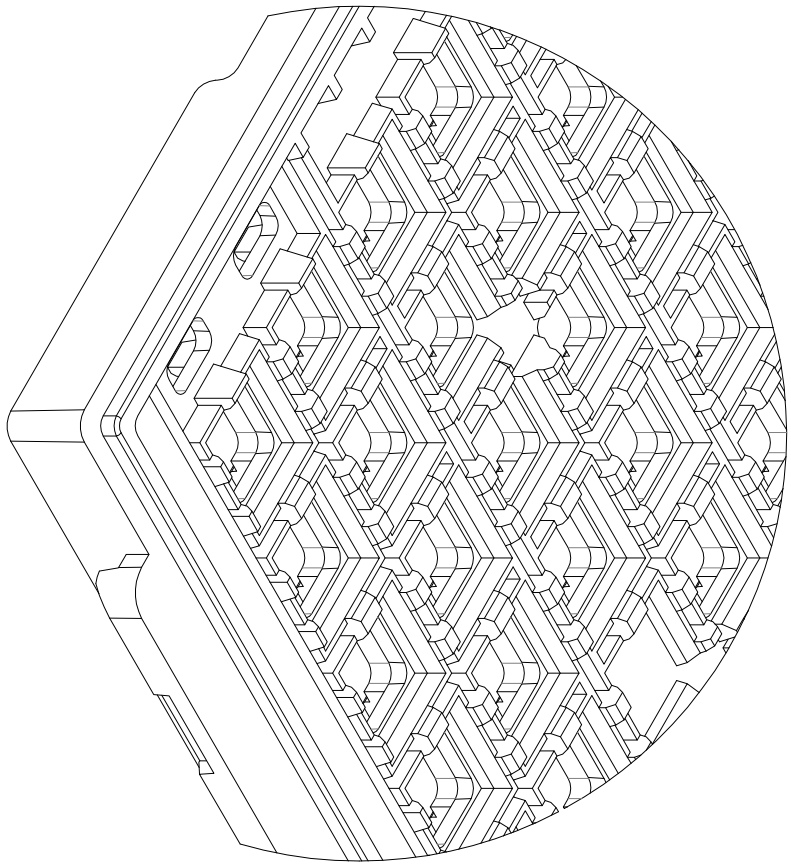

TOLERANCES UNLESS OTHERWISE SPECIFIED		ANGLE	
DECIMAL	.X ± .25	ANGLE	± .5°
.XX	± .13		
.XXX	± .13		
APPROVALS	DATE		
DRAWN			
KK	29 FEB 16		
TITLE:		SCALE	
BV/BVG 160 SHIPPING TRAY		N/A	
STOCK NO.	DRAWING NO.	SIZE	REV
N/A	MSC-7743-A	N/A	00
DO NOT SCALE DRAWING		SHEET 3 OF 3	

 6024 Silver Creek Valley Road
 San Jose, CA 95138
 PHONE: (408) 284-8200
 FAX: (408) 284-3572

www.IDT.com