

3226REF

315.0

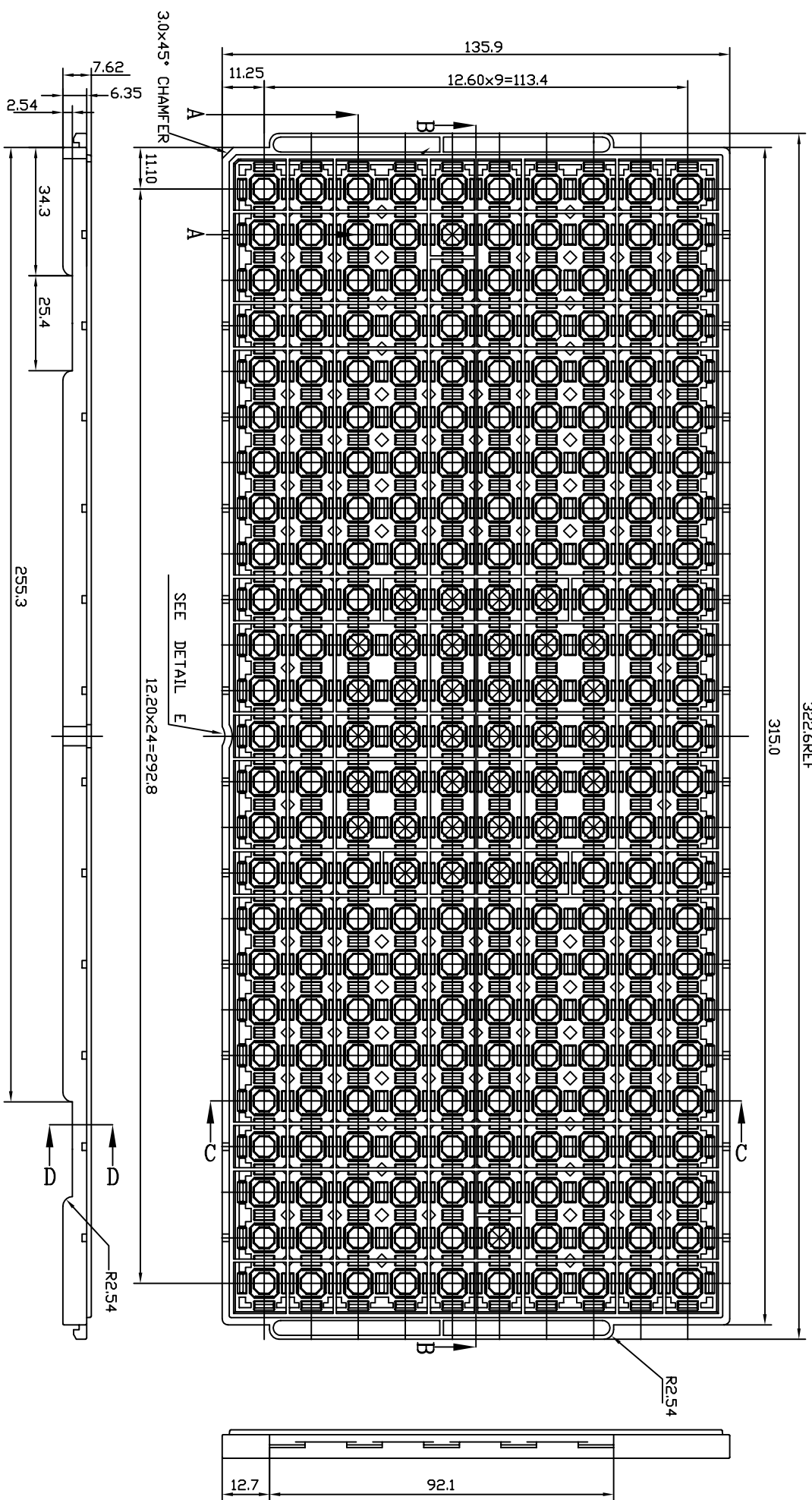

- NOTES : (UNLESS OTHERWISE SPECIFIED)
 1. ALL DIMENSIONS ARE IN mm.
 2. NUMBER OF POCKETS : 10 X 25 = 250 POCKETS

TOLERANCES UNLESS OTHERWISE SPECIFIED		DECIMAL 25		ANGLE ±.5°	
X ± .25		XX ± .13		XXX ± .13	
APPROVALS	DATE	WWW.IDT.COM			
DRAWN		TITLE: ES/ESG 48 & PR/PRG 32/48 SHIPPING TRAY			
		STOCK NO. N/A			
		DRAWING NO. MSC-5807-A			
		REV N/A			
		SCALE N/A			



6024 Silver Creek Valley Road,
 San Jose, CA 95138
 PHONE: (408) 284-8200
 FAX: (408) 284-3572

DO NOT SCALE DRAWING SHEET 1 OF 2

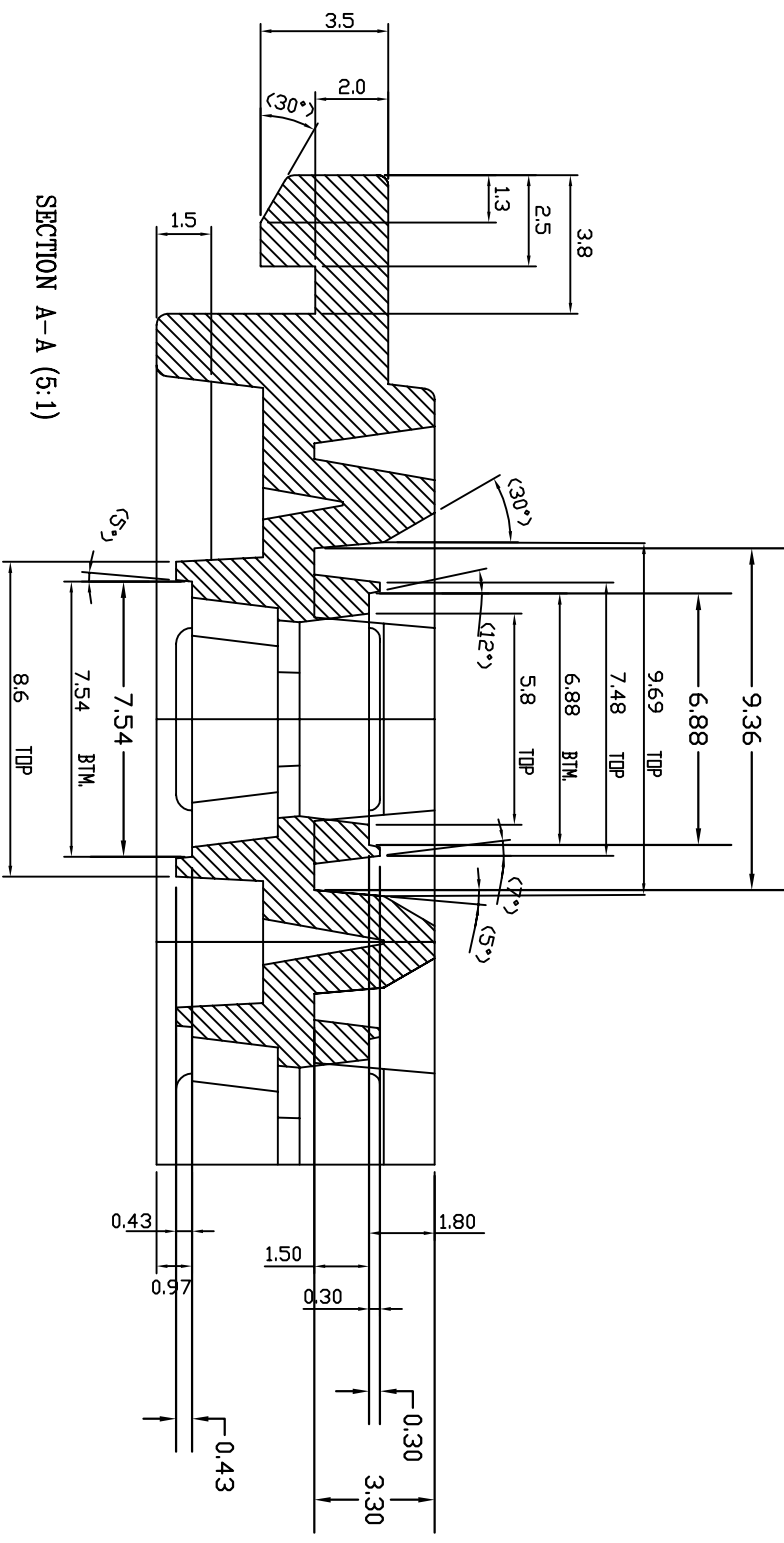

SECTION A-A (5:1)

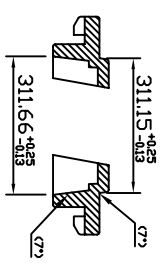

SECTION B - B(1:1)

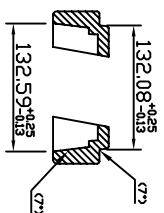

SECTION C - C(1:1)

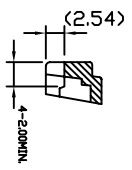

SECTION D - D(1:1)

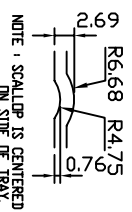

DETAIL E(1:1)

NOTE: SCALLOP IS CENTERED ON SIDE OF TRAY.

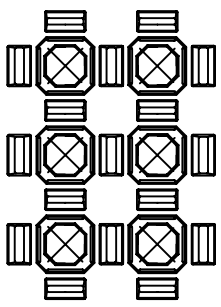

DETAIL CELL

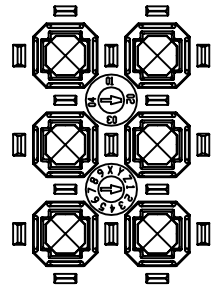

DETAIL CELL(BACK VIEW)

TOLERANCES UNLESS OTHERWISE SPECIFIED		DECIMAL		ANGLE	
.XX	± .25	°	± .5°		
.XXX	± .13				
APPROVALS		DATE			
DRAWN					
TITLE:		WWW.IDT.COM		SCALE	
ES/ESG 48 & PR/PRG 32/48		6024 Silver Creek Valley Road,		N/A	
SHIPPING TRAY		San Jose, CA 95138		N/A	
STOCK NO. N/A		PHONE: (408) 284-8200		REV	
DRAWING NO. MSC-5807-A		FAX: (408) 284-3572		00	
DO NOT SCALE DRAWING		SHEET 2 OF 2			



6024 Silver Creek Valley Road,
San Jose, CA 95138
PHONE: (408) 284-8200
FAX: (408) 284-3572

ES/ESG 48 & PR/PRG 32/48
SHIPPING TRAY
STOCK NO. N/A
DRAWING NO. MSC-5807-A
DO NOT SCALE DRAWING