

NOTES : (UNLESS OTHERWISE SPECIFIED)
 1. NUMBER OF POCKET : 8 X 21 = 168 POCKETS

TOLERANCES UNLESS OTHERWISE SPECIFIED
 DECIMAL :
 .X ±.25
 .XX ±.13
 .XXX ±
 ANGL AR : ±.45



6024 Silver Creek Valley Road,
 San Jose, CA 95138
 PHONE: (408) 284-8200
 FAX: (408) 284-5572

TITLE:		N/A	
N/G TRAY		N/A	
STOCK NO.		N/A	
DRAWING NO.		MSC-7984-A	
SCALE		N/A	
REV		00	
DO NOT SCALE DRAWING		SHEET 1 OF 2	

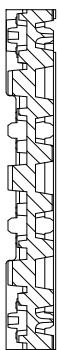
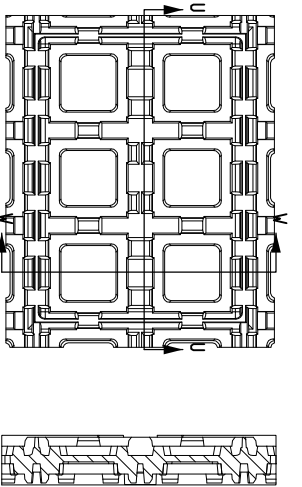
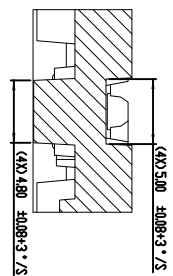
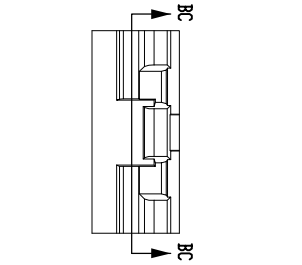
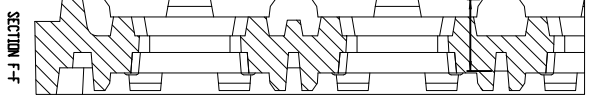
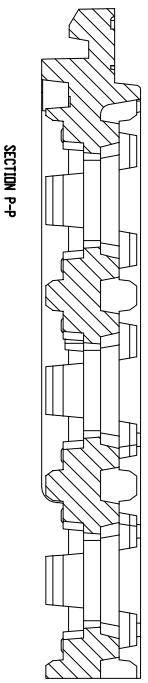
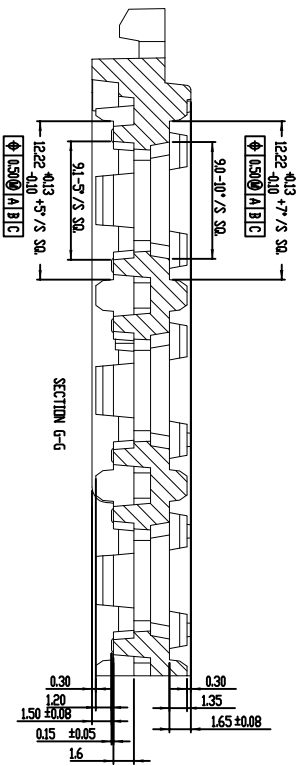
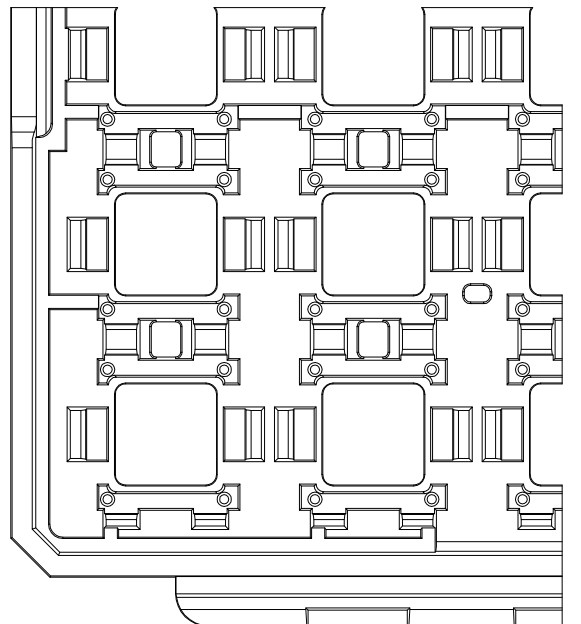
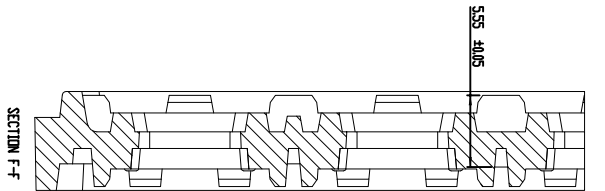
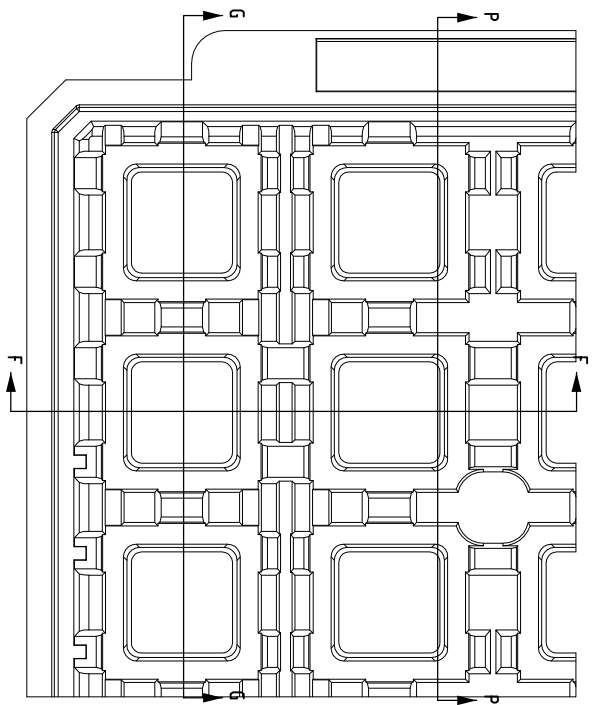

SECTION V-V
SCALE 2:1

TOLERANCES UNLESS OTHERWISE SPECIFIED
 DECIMAL :
 .X ±.25
 .XX ±.13
 .XXX ±
 ANGLAR : ±°



6024 Silver Creek Valley Road,
 San Jose, CA 95138
 PHONE: (408) 284-8200
 FAX: (408) 284-5572

TITLE:	SCALE
NYG 88 & NYG 88 SHIPPING	N/A
TRAY	SIZE
	N/A
STOCK NO.	REV
N/A	00
DRAWING NO.	
MSC-7984-A	
DO NOT SCALE DRAWING	SHEET 2 OF 2