

Description

The 551S is a low cost, high-speed single input to four output clock buffer. The 551S has best in class Additive Phase Jitter of sub 50fsec.

IDT makes many non-PLL and PLL based low skew output clock devices as well as Zero Delay Buffers to synchronize clocks. Contact IDT for all of your clocking needs.

Features

- Low additive phase jitter RMS: 50fs
- Extremely low skew outputs (50ps)
- Low cost clock buffer
- Packaged in 8-pin SOIC and 8-pin DFN, Pb-free
- Input/Output clock frequency up to 200MHz
- Non-inverting output clock
- Ideal for networking clocks
- Operating Voltages: 1.8V to 3.3V
- Output Enable mode tri-states outputs
- Advanced, low power CMOS process
- Extended temperature range (-40°C to +105°C)

Block Diagram

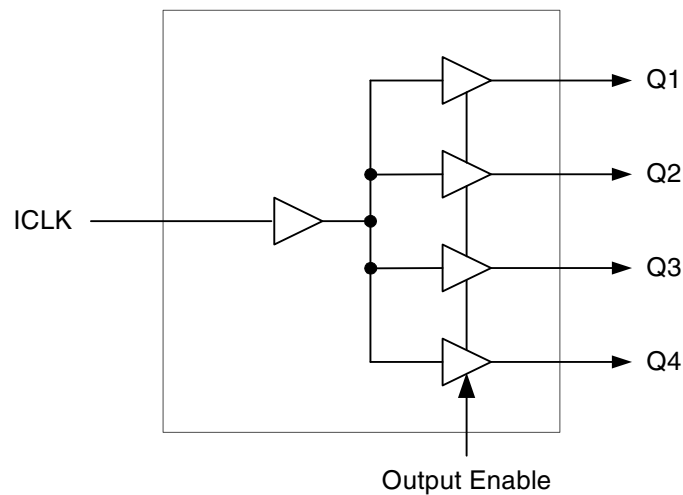

Pin Assignment

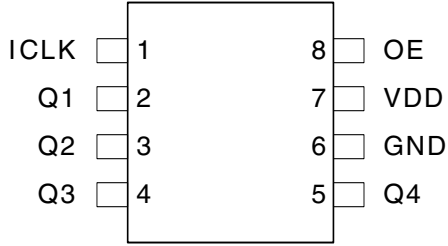

8 Pin (150 mil) SOIC

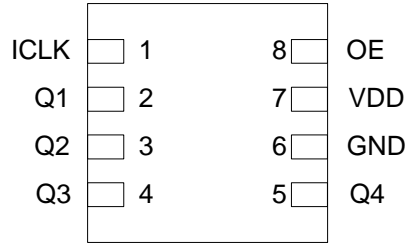

8-pin DFN

Pin Descriptions

Pin Number	Pin Name	Pin Type	Pin Description
1	ICLK	Input	Clock input. Internal pull-up resistor.
2	Q1	Output	Clock output 1.
3	Q2	Output	Clock output 2.
4	Q3	Output	Clock output 3.
5	Q4	Output	Clock output 4.
6	GND	Power	Connect to ground.
7	VDD	Power	Connect +1.8V, +2.5V or +3.3V.
8	OE	Input	Output Enable. Tri-states outputs when low. Internal pull-up resistor.

External Components

A minimum number of external components are required for proper operation. A decoupling capacitor of 0.01 μ F should be connected between VDD on pin 7 and GND on pin 6, as close to the device as possible. A 33 Ω series terminating resistor may be used on each clock output if the trace is longer than 1 inch.

Absolute Maximum Ratings

Stresses above the ratings listed below can cause permanent damage to the 551S. These ratings, which are standard values for IDT commercially rated parts, are stress ratings only. Functional operation of the device at these or any other conditions above those indicated in the operational sections of the specifications is not implied. Exposure to absolute maximum rating conditions for extended periods can affect product reliability. Electrical parameters are guaranteed only over the recommended operating temperature range.

Item	Rating
Supply Voltage, VDD	3.465V
All Inputs and Outputs	-0.5 V to 3.465V
Ambient Operating Temperature, Extended	-40 to +105°C
Storage Temperature	-65 to +150°C
Junction Temperature	125°C
Soldering Temperature	260°C

Recommended Operation Conditions

Parameter	Min.	Typ.	Max.	Units
Ambient Operating Temperature, extended	-40	–	+105	°C
Power Supply Voltage (measured in respect to GND)	+1.71		+3.465	V

DC Electrical Characteristics

VDD=1.8V ±5%, Ambient temperature -40° to +105°C, unless stated otherwise

Parameter	Symbol	Conditions	Min.	Typ.	Max.	Units
Operating Voltage	VDD		1.71		1.89	V
Input High Voltage, ICLK	V _{IH}	Note 1	0.7xVDD		1.89	V
Input Low Voltage, ICLK	V _{IL}	Note 1			0.3xVDD	V
Input High Voltage, OE	V _{IH}		0.7xVDD		VDD	V
Input Low Voltage, OE	V _{IL}				0.3xVDD	V
Output High Voltage	V _{OH}	I _{OH} = -10 mA	1.3			V
Output Low Voltage	V _{OL}	I _{OL} = 10 mA			0.35	V
Operating Supply Current	IDD	No load, 135 MHz		13		mA
Nominal Output Impedance	Z _O			17		Ω
Input Capacitance	C _{IN}	OE pin		5		pF

Notes: 1. Nominal switching threshold is VDD/2.

VDD=2.5V ±5%, Ambient temperature -40° to +105°C, unless stated otherwise

Parameter	Symbol	Conditions	Min.	Typ.	Max.	Units
Operating Voltage	VDD		2.375		2.625	V
Input High Voltage, ICLK	V _{IH}	Note 1	0.7xVDD		2.625	V
Input Low Voltage, ICLK	V _{IL}	Note 1			0.3xVDD	V
Input High Voltage, OE	V _{IH}		0.7xVDD		VDD	V
Input Low Voltage, OE	V _{IL}				0.3xVDD	V
Output High Voltage	V _{OH}	I _{OH} = -16 mA	1.8			V
Output Low Voltage	V _{OL}	I _{OL} = 16 mA			0.5	V
Operating Supply Current	IDD	No load, 135 MHz		18		mA
Nominal Output Impedance	Z _O			17		Ω
Input Capacitance	C _{IN}	OE pin		5		pF

Notes: 1. Nominal switching threshold is VDD/2.

VDD=3.3V ±5%, Ambient temperature -40° to +105°C, unless stated otherwise

Parameter	Symbol	Conditions	Min.	Typ.	Max.	Units
Operating Voltage	VDD		3.135		3.465	V
Input High Voltage, ICLK	V _{IH}	Note 1	0.7xVDD		3.465	V
Input Low Voltage, ICLK	V _{IL}	Note 1			0.3xVDD	V
Input High Voltage, OE	V _{IH}		0.7xVDD		VDD	V
Input Low Voltage, OE	V _{IL}				0.3xVDD	V
Output High Voltage	V _{OH}	I _{OH} = -25 mA	2.2			V
Output Low Voltage	V _{OL}	I _{OL} = 25 mA			0.7	V
Operating Supply Current	IDD	No load, 135 MHz		22		mA
Nominal Output Impedance	Z _O			17		Ω
Input Capacitance	C _{IN}	OE pin		5		pF

Notes: 1. Nominal switching threshold is VDD/2.

AC Electrical Characteristics

VDD=1.8V ±5%, Ambient Temperature -40° to +105°C, unless stated otherwise

Parameter	Symbol	Conditions	Min.	Typ.	Max.	Units
Output Frequency		5pF load, Note 4			200	MHz
Output Clock Rise Time	t _{OR}	0.36 to 1.44 V		0.6	1.0	ns
Output Clock Fall Time	t _{OF}	1.44 to 0.36V		0.6	1.0	ns
Propagation Delay		135 MHz, Note 1	1.5	2	4	ns
Buffer Additive Phase Jitter, RMS		125MHz, Integration range: 12kHz–20MHz		0.03	0.05	ps
Output to Output Skew		Rising edges at VDD/2, Note 2		50	65	ps
Start-up Time	t _{START-UP}	Part start-up time for valid outputs after VDD ramp-up			2	ms
Output Enable Time	t _{EN}	CL ≤ 5pF			3	cycles
Output Disable Time	t _{DIS}	CL ≤ 5pF			3	cycles

VDD=2.5V ±5%, Ambient Temperature -40° to +105°C, unless stated otherwise

Parameter	Symbol	Conditions	Min.	Typ.	Max.	Units
Output Frequency		5pF load, Note 4			200	MHz
Output Clock Rise Time	t _{OR}	0.5 to 2.0V		0.6	1.0	ns
Output Clock Fall Time	t _{OF}	2.0 to 0.5V		0.6	1.0	ns
Propagation Delay		135 MHz, Note 1	1.8	2.5	4.5	ns
Buffer Additive Phase Jitter, RMS		125MHz, Integration range: 12kHz–20MHz		0.035	0.05	ps
Output to Output Skew		Rising edges at VDD/2, Note 2		50	65	ps
Start-up Time	t _{START-UP}	Part start-up time for valid outputs after VDD ramp-up			2	ms
Output Enable Time	t _{EN}	CL ≤ 5pF			3	cycles
Output Disable Time	t _{DIS}	CL ≤ 5pF			3	cycles

VDD=3.3V ±5%, Ambient Temperature -40° to +105°C, unless stated otherwise

Parameter	Symbol	Conditions	Min.	Typ.	Max.	Units
Output Frequency		5pF load, Note 4			200	MHz
Output Clock Rise Time	t _{OR}	0.66 to 2.64V		0.6	1.0	ns
Output Clock Fall Time	t _{OF}	2.64 to 0.66V		0.6	1.0	ns
Propagation Delay		135 MHz, Note 1	1.5	2	4	ns
Buffer Additive Phase Jitter, RMS		125MHz, Integration range: 12kHz–20MHz		0.037	0.05	ps
Output to Output Skew		Rising edges at VDD/2, Note 2		50	65	ps
Start-up Time	t _{START-UP}	Part start-up time for valid outputs after VDD ramp-up			2	ms
Output Enable Time	t _{EN}	CL ≤ 5pF			3	cycles
Output Disable Time	t _{DIS}	CL ≤ 5pF			3	cycles

Notes:

1. With rail to rail input clock.
2. Between any 2 outputs with equal loading.
3. Duty cycle on outputs will match incoming clock duty cycle. Consult IDT for tight duty cycle clock generators.
4. With external series resistor of 33Ω positioned close to each output pin.

Phase Noise Plots

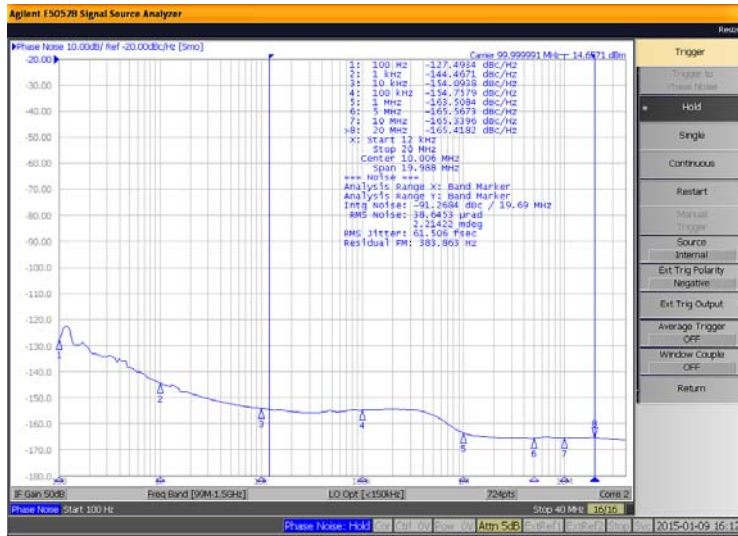

Figure 1. 551S Reference Phase Noise 62fs (12kHz to 20MHz)

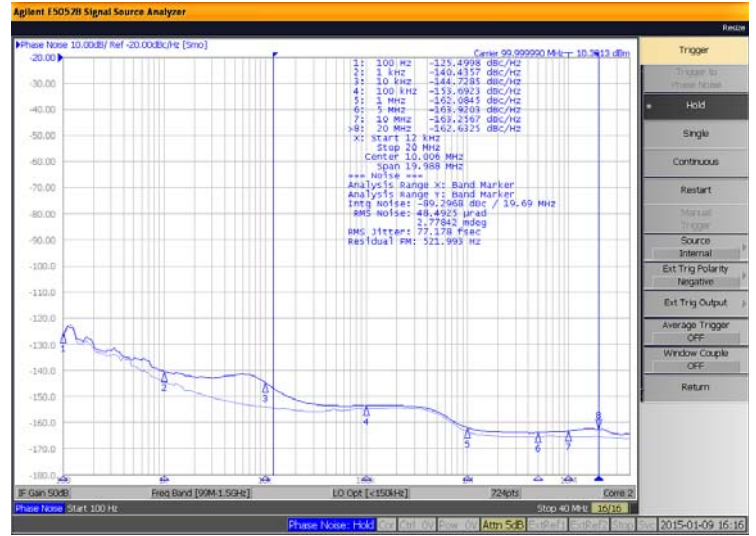
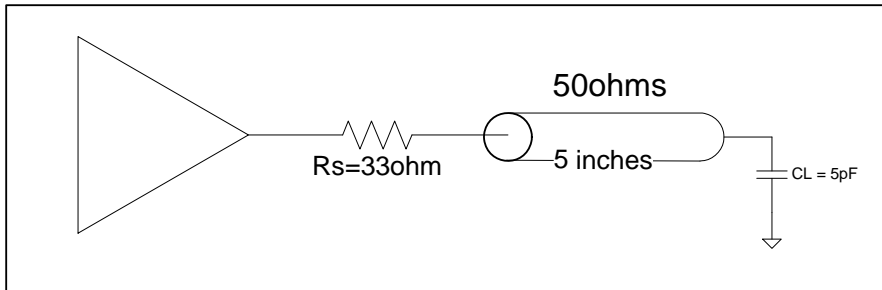

Figure 2. 551S Output Phase Noise 77fs (12kHz to 20MHz)

The phase noise plots above show the low Additive Jitter of the 551S high-performance buffer. With an integration range of 12kHz to 20MHz, the reference input has about 62fs of RMS phase jitter while the output of 551S has about 77fs of RMS phase jitter. This results in a low Additive Phase Jitter of only 45fs.

Test Load and Circuit



Thermal Characteristics (8SOIC)

Parameter	Symbol	Conditions	Min.	Typ.	Max.	Units
Thermal Resistance Junction to Ambient	θ_{JA}	Still air		150		°C/W
	θ_{JA}	1 m/s air flow		140		°C/W
	θ_{JA}	3 m/s air flow		120		°C/W
Thermal Resistance Junction to Board	θ_{JB}			89		°C/W
Thermal Resistance Junction to Case	θ_{JC}			40		°C/W

Marking Diagrams

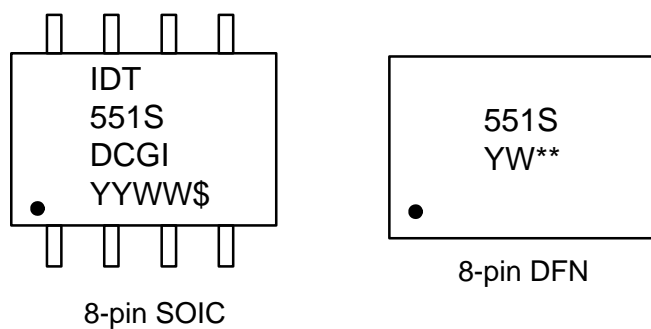

Notes:

1. “**” is the lot number.
2. “YYWW” or “YW” are the last digits of the year and week that the part was assembled.
- 3 “G” denotes RoHS compliant package.
4. “\$” denotes the mark code.
5. “I” denotes extended temperature range device.

Package Outline Drawings

The package outline drawings are appended at the end of this document and are accessible from the link below. The package information is the most current data available.

www.idt.com/document/psc/dcg8-package-outline-drawing-0150-body-width-0050-pitch-soic

www.idt.com/document/psc/cm88-package-outline-drawing-20-x-20-x-05-mm-body-05mm-pitch-dfn

Ordering Information

Part / Order Number	Marking	Shipping Packaging	Package	Temperature
551SDCGI	see page 7	Tubes	8-pin SOIC	-40 to +105 °C
551SDCGI8		Tape and Reel	8-pin SOIC	-40 to +105 °C
551SCMGI		Cut Tape	8-pin DFN	-40 to +105 °C
551SCMGI8		Tape and Reel	8-pin DFN	-40 to +105 °C

“G” suffix to the part number denotes Pb-Free configuration, RoHS compliant.

Revision History

Date	Description of Change
September 20, 2018	<ul style="list-style-type: none"> Added Thermal Resistance Junction to Board to Thermal Characteristics table. Updated Package Outline Drawings section.
March 18, 2015	Initial release.

Notice

1. Descriptions of circuits, software and other related information in this document are provided only to illustrate the operation of semiconductor products and application examples. You are fully responsible for the incorporation or any other use of the circuits, software, and information in the design of your product or system. Renesas Electronics disclaims any and all liability for any losses and damages incurred by you or third parties arising from the use of these circuits, software, or information.
2. Renesas Electronics hereby expressly disclaims any warranties against and liability for infringement or any other claims involving patents, copyrights, or other intellectual property rights of third parties, by or arising from the use of Renesas Electronics products or technical information described in this document, including but not limited to, the product data, drawings, charts, programs, algorithms, and application examples.
3. No license, express, implied or otherwise, is granted hereby under any patents, copyrights or other intellectual property rights of Renesas Electronics or others.
4. You shall not alter, modify, copy, or reverse engineer any Renesas Electronics product, whether in whole or in part. Renesas Electronics disclaims any and all liability for any losses or damages incurred by you or third parties arising from such alteration, modification, copying or reverse engineering.
5. Renesas Electronics products are classified according to the following two quality grades: "Standard" and "High Quality". The intended applications for each Renesas Electronics product depends on the product's quality grade, as indicated below.
 - "Standard": Computers; office equipment; communications equipment; test and measurement equipment; audio and visual equipment; home electronic appliances; machine tools; personal electronic equipment; industrial robots; etc.
 - "High Quality": Transportation equipment (automobiles, trains, ships, etc.); traffic control (traffic lights); large-scale communication equipment; key financial terminal systems; safety control equipment; etc.Unless expressly designated as a high reliability product or a product for harsh environments in a Renesas Electronics data sheet or other Renesas Electronics document, Renesas Electronics products are not intended or authorized for use in products or systems that may pose a direct threat to human life or bodily injury (artificial life support devices or systems; surgical implantations; etc.), or may cause serious property damage (space system; undersea repeaters; nuclear power control systems; aircraft control systems; key plant systems; military equipment; etc.). Renesas Electronics disclaims any and all liability for any damages or losses incurred by you or any third parties arising from the use of any Renesas Electronics product that is inconsistent with any Renesas Electronics data sheet, user's manual or other Renesas Electronics document.
6. When using Renesas Electronics products, refer to the latest product information (data sheets, user's manuals, application notes, "General Notes for Handling and Using Semiconductor Devices" in the reliability handbook, etc.), and ensure that usage conditions are within the ranges specified by Renesas Electronics with respect to maximum ratings, operating power supply voltage range, heat dissipation characteristics, installation, etc. Renesas Electronics disclaims any and all liability for any malfunctions, failure or accident arising out of the use of Renesas Electronics products outside of such specified ranges.
7. Although Renesas Electronics endeavors to improve the quality and reliability of Renesas Electronics products, semiconductor products have specific characteristics, such as the occurrence of failure at a certain rate and malfunctions under certain use conditions. Unless designated as a high reliability product or a product for harsh environments in a Renesas Electronics data sheet or other Renesas Electronics document, Renesas Electronics products are not subject to radiation resistance design. You are responsible for implementing safety measures to guard against the possibility of bodily injury, injury or damage caused by fire, and/or danger to the public in the event of a failure or malfunction of Renesas Electronics products, such as safety design for hardware and software, including but not limited to redundancy, fire control and malfunction prevention, appropriate treatment for aging degradation or any other appropriate measures. Because the evaluation of microcomputer software alone is very difficult and impractical, you are responsible for evaluating the safety of the final products or systems manufactured by you.
8. Please contact a Renesas Electronics sales office for details as to environmental matters such as the environmental compatibility of each Renesas Electronics product. You are responsible for carefully and sufficiently investigating applicable laws and regulations that regulate the inclusion or use of controlled substances, including without limitation, the EU RoHS Directive, and using Renesas Electronics products in compliance with all these applicable laws and regulations. Renesas Electronics disclaims any and all liability for damages or losses occurring as a result of your noncompliance with applicable laws and regulations.
9. Renesas Electronics products and technologies shall not be used for or incorporated into any products or systems whose manufacture, use, or sale is prohibited under any applicable domestic or foreign laws or regulations. You shall comply with any applicable export control laws and regulations promulgated and administered by the governments of any countries asserting jurisdiction over the parties or transactions.
10. It is the responsibility of the buyer or distributor of Renesas Electronics products, or any other party who distributes, disposes of, or otherwise sells or transfers the product to a third party, to notify such third party in advance of the contents and conditions set forth in this document.
11. This document shall not be reprinted, reproduced or duplicated in any form, in whole or in part, without prior written consent of Renesas Electronics.
12. Please contact a Renesas Electronics sales office if you have any questions regarding the information contained in this document or Renesas Electronics products.

(Note1) "Renesas Electronics" as used in this document means Renesas Electronics Corporation and also includes its directly or indirectly controlled subsidiaries.

(Note2) "Renesas Electronics product(s)" means any product developed or manufactured by or for Renesas Electronics.

(Rev.4.0-1 November 2017)

Corporate Headquarters

TOYOSU FORESIA, 3-2-24 Toyosu,
Koto-ku, Tokyo 135-0061, Japan
www.renesas.com

Contact Information

For further information on a product, technology, the most up-to-date version of a document, or your nearest sales office, please visit:
www.renesas.com/contact/

Trademarks

Renesas and the Renesas logo are trademarks of Renesas Electronics Corporation. All trademarks and registered trademarks are the property of their respective owners.