

Features

- ◆ 1M x 4 advanced high-speed CMOS Static RAM
- ◆ JEDEC Center Power / GND pinout for reduced noise
- ◆ Equal access and cycle times
— Commercial and Industrial: 10/12/15ns
- ◆ Single 3.3V power supply
- ◆ One Chip Select plus one Output Enable pin
- ◆ Bidirectional data inputs and outputs directly LVTTTL-compatible
- ◆ Low power consumption via chip deselect
- ◆ Available in 32-pin, 400 mil plastic SOJ package
- ◆ Green parts available, see ordering information

Description

The IDT71V428 is a 4,194,304-bit high-speed Static RAM organized as 1M x 4. It is fabricated using IDT's high-performance, high-reliability CMOS technology. This state-of-the-art technology, combined with innovative circuit design techniques, provides a cost-effective solution for high-speed memory needs.

The IDT71V428 has an output enable pin which operates as fast as 5ns, with address access times as fast as 10ns. All bidirectional inputs and outputs of the IDT71V428 are LVTTTL-compatible and operation is from a single 3.3V supply. Fully static asynchronous circuitry is used, requiring no clocks or refresh for operation.

The IDT71V428 is packaged in a 32-pin, 400 mil Plastic SOJ.

Functional Block Diagram

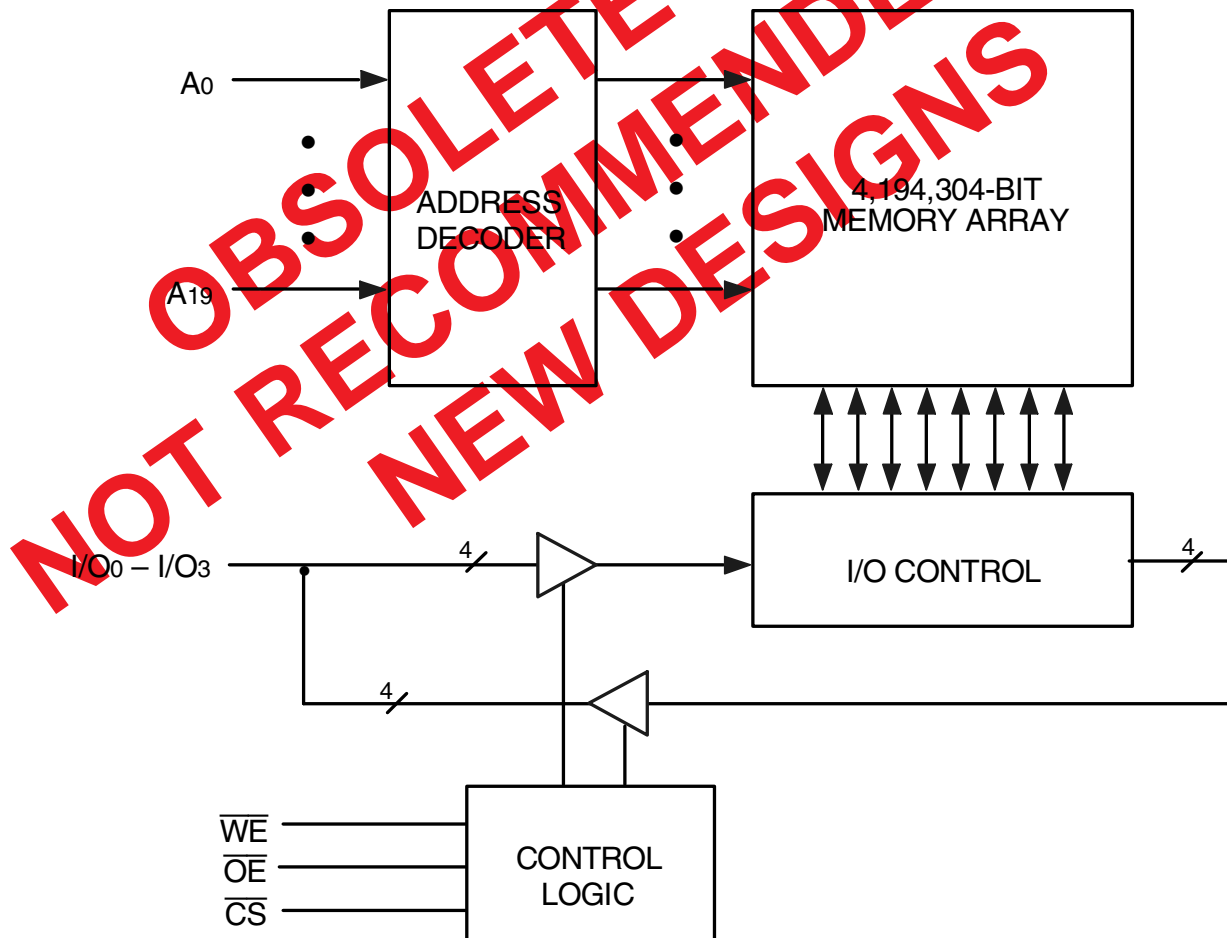

3623 drw 01

JULY 2014

Pin Configuration

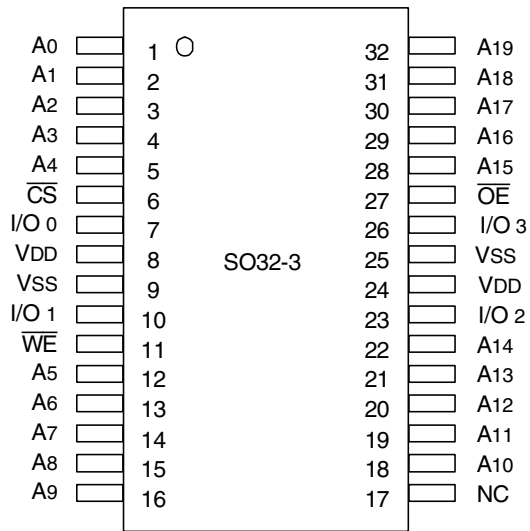

SOJ Top View

3623 drw 02

Pin Description

A0 - A19	Address Inputs	Input
\overline{CS}	Chip Select	Input
\overline{WE}	Write Enable	Input
\overline{OE}	Output Enable	Input
I/O ₀ - I/O ₃	Data Input/Output	I/O
VDD	3.3V Power	Power
VSS	Ground	Gnd

3623 tbl 02

Capacitance

(T_A = +25°C, f = 1.0MHz, SOJ package)

Symbol	Parameter ⁽¹⁾	Conditions	Max.	Unit
C _{IN}	Input Capacitance	V _{IN} = 3dV	7	pF
C _{I/O}	I/O Capacitance	V _{OUT} = 3dV	8	pF

3623 tbl 03

NOTE:

- This parameter is guaranteed by device characterization, but not production tested.

Truth Table^(1,2)

\overline{CS}	\overline{OE}	\overline{WE}	I/O	Function
L	L	H	DATA _{OUT}	Read Data
L	X	L	DATA _{IN}	Write Data
L	H	H	High-Z	Output Disabled
H	X	X	High-Z	Deselected - Standby (I _{SB})
V _{HC} ⁽³⁾	X	X	High-Z	Deselected - Standby (I _{SB1})

3623 tbl 01

NOTES:

- H = V_{IH}, L = V_{IL}, x = Don't care.
- V_{LC} = 0.2V, V_{HC} = V_{CC} - 0.2V.
- Other inputs ≥ V_{HC} or ≤ V_{LC}.

Absolute Maximum Ratings⁽¹⁾

Symbol	Rating	Value	Unit
V _{DD}	Supply Voltage Relative to V _{SS}	-0.5 to +4.6	V
V _{IN} , V _{OUT}	Terminal Voltage Relative to V _{SS}	-0.5 to V _{DD} +0.5	V
T _{BIAS}	Temperature Under Bias	-55 to +125	°C
T _{STG}	Storage Temperature	-55 to +125	°C
P _T	Power Dissipation	1	W
I _{OUT}	DC Output Current	50	mA

3623 tbl 04

NOTE:

- Stresses greater than those listed under ABSOLUTE MAXIMUM RATINGS may cause permanent damage to the device. This is a stress rating only and functional operation of the device at these or any other conditions above those indicated in the operational sections of this specification is not implied. Exposure to absolute maximum rating conditions for extended periods may affect reliability.

Recommended Operating Temperature and Supply Voltage

Grade	Temperature	V _{SS}	V _{DD}
Commercial	0°C to +70°C	0V	See Below
Industrial	-40°C to +85°C	0V	See Below

3623 tbl 05

Recommended DC Operating Conditions

Symbol	Parameter	Min.	Typ.	Max.	Unit
V _{DD}	Supply Voltage	3.0	3.3	3.6	V
V _{SS}	Ground	0	0	0	V
V _{IH}	Input High Voltage	2.0	—	V _{DD} +0.3 ⁽¹⁾	V
V _{IL}	Input Low Voltage	-0.3 ⁽²⁾	—	0.8	V

3623 tbl 06

NOTES:

- V_{IH} (max.) = V_{DD}+2V for pulse width less than 5ns, once per cycle.
- V_{IL} (min.) = -2V for pulse width less than 5ns, once per cycle.

DC Electrical Characteristics

(V_{DD} = Min. to Max., Commercial and Industrial Temperature Ranges)

Symbol	Parameter	Test Condition	IDT71V428		Unit
			Min.	Max.	
I _L	Input Leakage Current	V _{DD} = Max., V _{IN} = V _{SS} to V _{DD}	—	5	μA
I _{LO}	Output Leakage Current	V _{DD} = Max., \overline{CS} = V _{IH} , V _{OUT} = V _{SS} to V _{DD}	—	5	μA
V _{OL}	Output Low Voltage	I _{OL} = 8mA, V _{DD} = Min.	—	0.4	V
V _{OH}	Output High Voltage	I _{OH} = -4mA, V _{DD} = Min.	2.4	—	V

3623 tbl 07

DC Electrical Characteristics^(1,2,3)

(V_{DD} = Min. to Max., V_{LC} = 0.2V, V_{HC} = V_{DD} - 0.2V)

Symbol	Parameter		71V428S/L10		71V428S/L12		71V428S/L15		Unit
			Com'l.	Ind. ⁽⁵⁾	Com'l.	Ind.	Com'l.	Ind.	
I _{CC}	Dynamic Operating Current $\overline{CS} \leq V_{LC}$, Outputs Open, V _{DD} = Max., f = f _{MAX} ⁽⁴⁾	S	150	150	140	140	130	130	mA
		L	140	—	130	130	120	120	mA
I _{SB}	Dynamic Standby Power Supply Current $\overline{CS} \geq V_{HC}$, Outputs Open, V _{DD} = Max., f = f _{MAX} ⁽⁴⁾	S	60	60	50	50	40	40	mA
		L	40	—	35	35	30	30	mA
I _{SB1}	Full Standby Power Supply Current (static) $\overline{CS} \geq V_{HC}$, Outputs Open, V _{DD} = Max., f = 0 ⁽⁴⁾	S	20	20	20	20	20	20	mA
		L	10	—	10	10	10	10	mA

3623 tbl 08

NOTES:

- All values are maximum guaranteed values.
- All inputs switch between 0.2V (Low) and V_{DD} - 0.2V (High).
- Power specifications are preliminary.
- f_{MAX} = 1/trc (all address inputs are cycling at f_{MAX}); f = 0 means no address input lines are changing.
- Standard power 10ns (S10) speed grade only.

AC Test Conditions

Input Pulse Levels	GND to 3.0V
Input Rise/Fall Times	1.5ns
Input Timing Reference Levels	1.5V
Output Reference Levels	1.5V
AC Test Load	See Figure 1, 2 and 3

3623 tbl 09

AC Test Loads

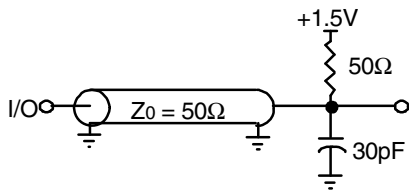

3623 drw 03

Figure 1. AC Test Load

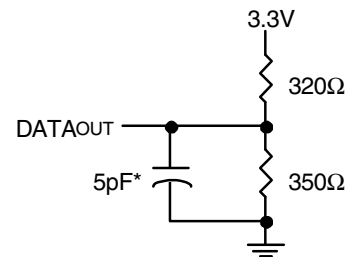

3623 drw 04

* Including jig and scope capacitance.

Figure 2. AC Test Load
(for tCLZ, tOLZ, tCHZ, tOHZ, tOW, and tWHZ)

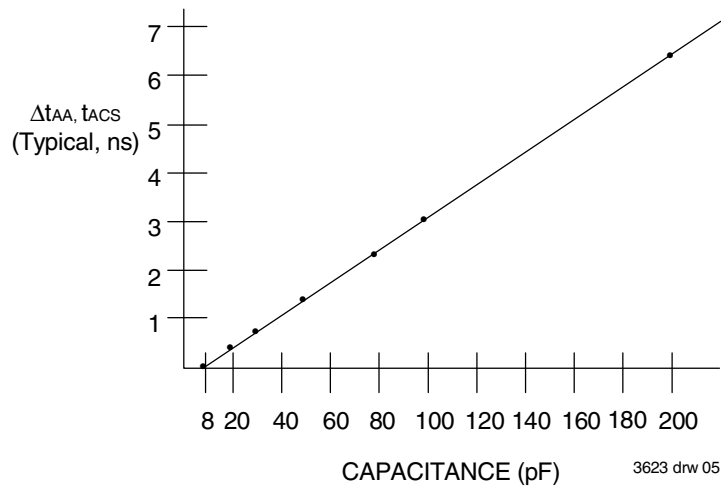

3623 drw 05

Figure 3. Output Capacitive Derating

AC Electrical Characteristics (V_{DD} = 3.3V ± 10%, Commercial and Industrial Temperature Ranges)

Symbol	Parameter	71V428S/L10 ⁽²⁾		71V428S/L12		71V428S/L15		Unit
		Min.	Max.	Min.	Max.	Min.	Max.	
READ CYCLE								
t _{RC}	Read Cycle Time	10	—	12	—	15	—	ns
t _{AA}	Address Access Time	—	10	—	12	—	15	ns
t _{ACS}	Chip Select Access Time	—	10	—	12	—	15	ns
t _{CLZ} ⁽¹⁾	Chip Select to Output in Low-Z	4	—	4	—	4	—	ns
t _{CHZ} ⁽¹⁾	Chip Deselect to Output in High-Z	—	5	—	6	—	7	ns
t _{OE}	Output Enable to Output Valid	—	5	—	6	—	7	ns
t _{OLZ} ⁽¹⁾	Output Enable to Output in Low-Z	0	—	0	—	0	—	ns
t _{OHZ} ⁽¹⁾	Output Disable to Output in High-Z	—	5	—	6	—	7	ns
t _{OH}	Output Hold from Address Change	4	—	4	—	4	—	ns
t _{PU} ⁽¹⁾	Chip Select to Power Up Time	0	—	0	—	0	—	ns
t _{PD} ⁽¹⁾	Chip Deselect to Power Down Time	—	10	—	12	—	15	ns
WRITE CYCLE								
t _{WC}	Write Cycle Time	10	—	12	—	15	—	ns
t _{AW}	Address Valid to End of Write	8	—	8	—	10	—	ns
t _{CW}	Chip Select to End of Write	8	—	8	—	10	—	ns
t _{AS}	Address Set-up Time	0	—	0	—	0	—	ns
t _{WP}	Write Pulse Width	8	—	8	—	10	—	ns
t _{WR}	Write Recovery Time	0	—	0	—	0	—	ns
t _{DW}	Data Valid to End of Write	6	—	6	—	7	—	ns
t _{DH}	Data Hold Time	0	—	0	—	0	—	ns
t _{OW} ⁽¹⁾	Output Active from End of Write	3	—	3	—	3	—	ns
t _{WHZ} ⁽¹⁾	Write Enable to Output in High-Z	—	6	—	7	—	7	ns

3623 tbl 10

NOTES:

1. This parameter guaranteed with the AC load (Figure 2) by device characterization, but is not production tested.
2. 0°C to +70°C temperature range only for low power 10ns (L10) speed grade.

Timing Waveform of Read Cycle No. 1⁽¹⁾

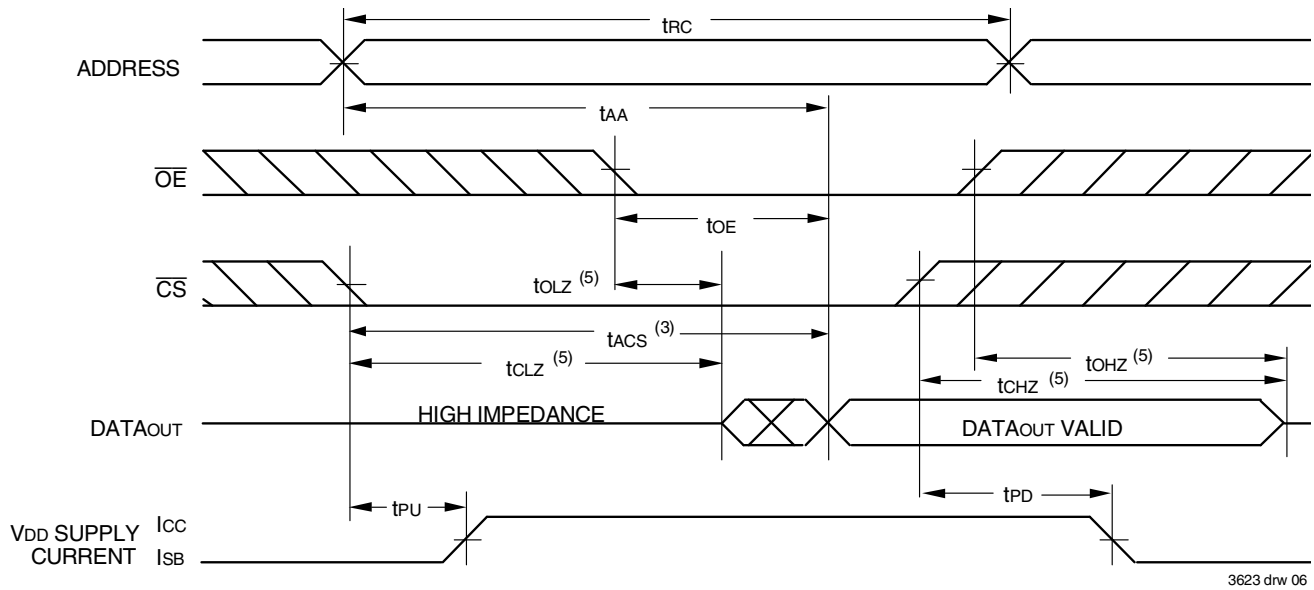

Timing Waveform of Read Cycle No. 2^(1,2,4)

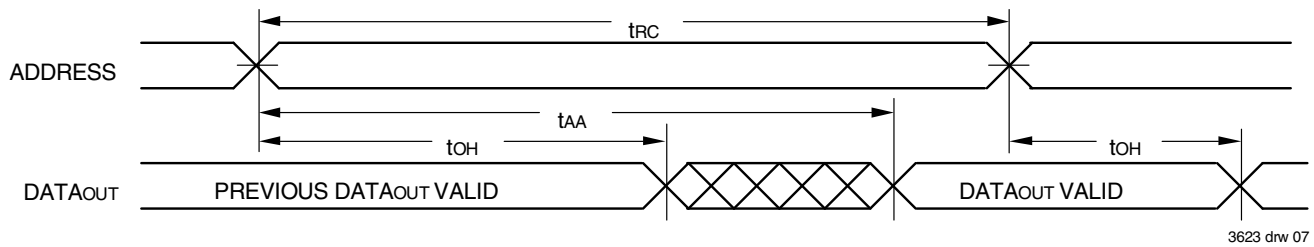

NOTES:

1. \overline{WE} is HIGH for Read Cycle.
2. Device is continuously selected, \overline{CS} is LOW.
3. Address must be valid prior to or coincident with the later of \overline{CS} transition LOW; otherwise t_{AA} is the limiting parameter.
4. \overline{OE} is LOW.
5. Transition is measured $\pm 200\text{mV}$ from steady state.

Timing Waveform of Write Cycle No.1 (\overline{WE} Controlled Timing)^(1,2,4)

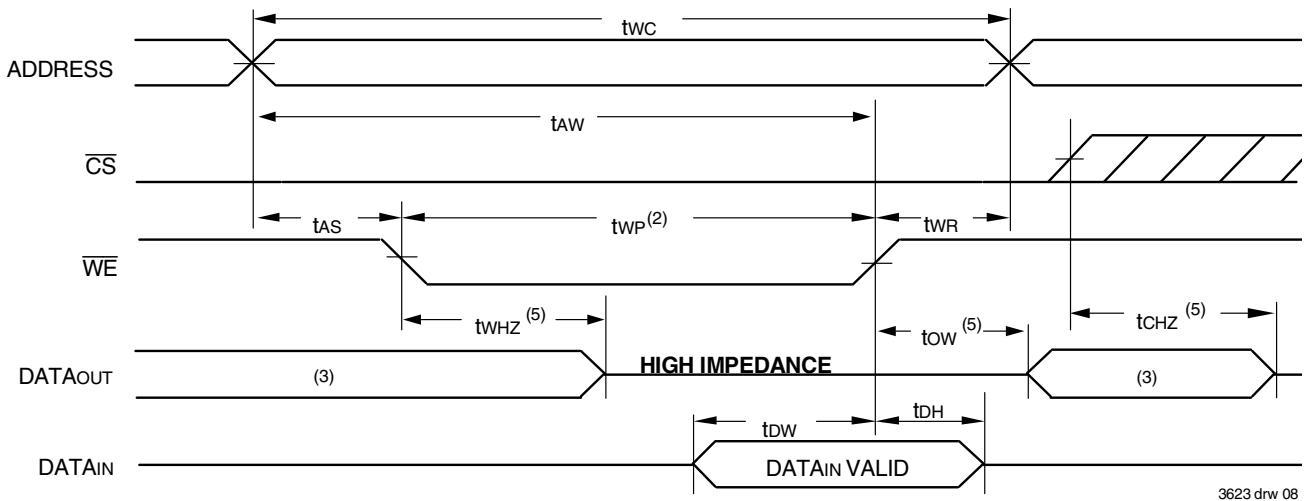

Timing Waveform of Write Cycle No.2 (\overline{CS} Controlled Timing)^(1,4)

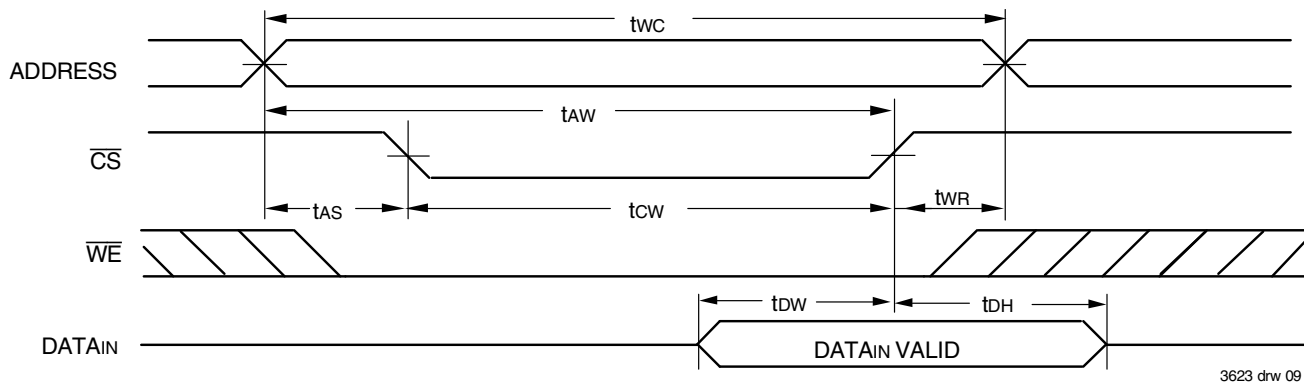

NOTES:

1. A write occurs during the overlap of a LOW \overline{CS} and a LOW \overline{WE} .
2. \overline{OE} is continuously HIGH. If during a \overline{WE} controlled write cycle \overline{OE} is LOW, t_{WP} must be greater than or equal to $t_{WHZ} + t_{OW}$ to allow the I/O drivers to turn off and data to be placed on the bus for the required t_{OW} . If \overline{OE} is HIGH during a \overline{WE} controlled write cycle, this requirement does not apply and the minimum write pulse is as short as the specified t_{WP} .
3. During this period, I/O pins are in the output state, and input signals must not be applied.
4. If the \overline{CS} LOW transition occurs simultaneously with or after the \overline{WE} LOW transition, the outputs remain in a high-impedance state.
5. Transition is measured $\pm 200\text{mV}$ from steady state.

Ordering Information

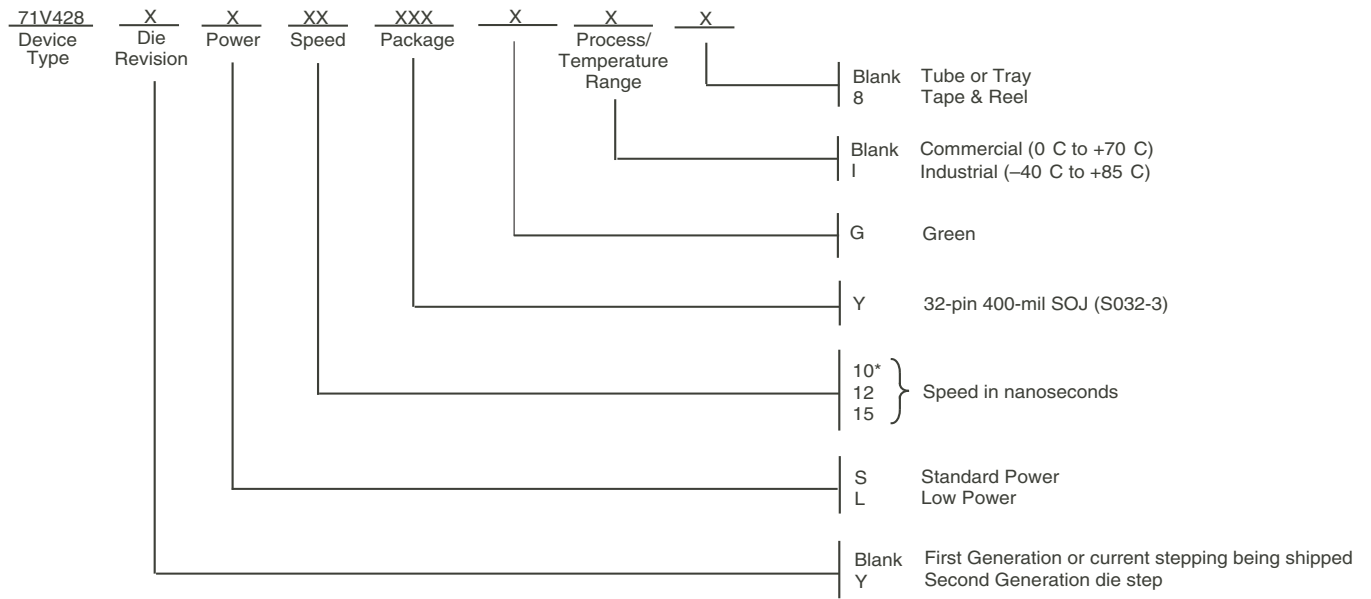

* Commercial only for low power (L10) speed grade.

3623 drw 10

Datasheet Document History

8/31/99		Updated to new format
	Pg. 2	Added footnote for VHC in Truth Table
	Pg. 4	Added footnote on jig and scope capacitance in Figure 2
	Pg. 7	Revised footnote on Write Cycle No. 1 diagram
	Pg. 9	Added Datasheet Document History
9/29/99	Pg. 1-9	Added Industrial temperature range offerings
11/26/02	Pg. 8	Updated ordering information for die revision
07/31/03	Pg. 8	Updated note, L10 speed grade commercial temperature only and updated die stepping from YF to Y.
09/30/04	Pg. 8	Added "Restricted hazardous substance device" to ordering information.
07/18/14	Pg. 1	Added green availability to Features
07/18/14	Pg. 8	Changed Restricted hazardous substance device indicator to Green in the ordering information
07/18/14	Pg. 8	Added T & R indicator to ordering Information
01/01/07		PDN-SR-0607. See IDT.com for PDN specifics

Notice

1. Descriptions of circuits, software and other related information in this document are provided only to illustrate the operation of semiconductor products and application examples. You are fully responsible for the incorporation or any other use of the circuits, software, and information in the design of your product or system. Renesas Electronics disclaims any and all liability for any losses and damages incurred by you or third parties arising from the use of these circuits, software, or information.
2. Renesas Electronics hereby expressly disclaims any warranties against and liability for infringement or any other claims involving patents, copyrights, or other intellectual property rights of third parties, by or arising from the use of Renesas Electronics products or technical information described in this document, including but not limited to, the product data, drawings, charts, programs, algorithms, and application examples.
3. No license, express, implied or otherwise, is granted hereby under any patents, copyrights or other intellectual property rights of Renesas Electronics or others.
4. You shall not alter, modify, copy, or reverse engineer any Renesas Electronics product, whether in whole or in part. Renesas Electronics disclaims any and all liability for any losses or damages incurred by you or third parties arising from such alteration, modification, copying or reverse engineering.
5. Renesas Electronics products are classified according to the following two quality grades: "Standard" and "High Quality". The intended applications for each Renesas Electronics product depends on the product's quality grade, as indicated below.
 - "Standard": Computers; office equipment; communications equipment; test and measurement equipment; audio and visual equipment; home electronic appliances; machine tools; personal electronic equipment; industrial robots; etc.
 - "High Quality": Transportation equipment (automobiles, trains, ships, etc.); traffic control (traffic lights); large-scale communication equipment; key financial terminal systems; safety control equipment; etc.Unless expressly designated as a high reliability product or a product for harsh environments in a Renesas Electronics data sheet or other Renesas Electronics document, Renesas Electronics products are not intended or authorized for use in products or systems that may pose a direct threat to human life or bodily injury (artificial life support devices or systems; surgical implantations; etc.), or may cause serious property damage (space system; undersea repeaters; nuclear power control systems; aircraft control systems; key plant systems; military equipment; etc.). Renesas Electronics disclaims any and all liability for any damages or losses incurred by you or any third parties arising from the use of any Renesas Electronics product that is inconsistent with any Renesas Electronics data sheet, user's manual or other Renesas Electronics document.
6. When using Renesas Electronics products, refer to the latest product information (data sheets, user's manuals, application notes, "General Notes for Handling and Using Semiconductor Devices" in the reliability handbook, etc.), and ensure that usage conditions are within the ranges specified by Renesas Electronics with respect to maximum ratings, operating power supply voltage range, heat dissipation characteristics, installation, etc. Renesas Electronics disclaims any and all liability for any malfunctions, failure or accident arising out of the use of Renesas Electronics products outside of such specified ranges.
7. Although Renesas Electronics endeavors to improve the quality and reliability of Renesas Electronics products, semiconductor products have specific characteristics, such as the occurrence of failure at a certain rate and malfunctions under certain use conditions. Unless designated as a high reliability product or a product for harsh environments in a Renesas Electronics data sheet or other Renesas Electronics document, Renesas Electronics products are not subject to radiation resistance design. You are responsible for implementing safety measures to guard against the possibility of bodily injury, injury or damage caused by fire, and/or danger to the public in the event of a failure or malfunction of Renesas Electronics products, such as safety design for hardware and software, including but not limited to redundancy, fire control and malfunction prevention, appropriate treatment for aging degradation or any other appropriate measures. Because the evaluation of microcomputer software alone is very difficult and impractical, you are responsible for evaluating the safety of the final products or systems manufactured by you.
8. Please contact a Renesas Electronics sales office for details as to environmental matters such as the environmental compatibility of each Renesas Electronics product. You are responsible for carefully and sufficiently investigating applicable laws and regulations that regulate the inclusion or use of controlled substances, including without limitation, the EU RoHS Directive, and using Renesas Electronics products in compliance with all these applicable laws and regulations. Renesas Electronics disclaims any and all liability for damages or losses occurring as a result of your noncompliance with applicable laws and regulations.
9. Renesas Electronics products and technologies shall not be used for or incorporated into any products or systems whose manufacture, use, or sale is prohibited under any applicable domestic or foreign laws or regulations. You shall comply with any applicable export control laws and regulations promulgated and administered by the governments of any countries asserting jurisdiction over the parties or transactions.
10. It is the responsibility of the buyer or distributor of Renesas Electronics products, or any other party who distributes, disposes of, or otherwise sells or transfers the product to a third party, to notify such third party in advance of the contents and conditions set forth in this document.
11. This document shall not be reprinted, reproduced or duplicated in any form, in whole or in part, without prior written consent of Renesas Electronics.
12. Please contact a Renesas Electronics sales office if you have any questions regarding the information contained in this document or Renesas Electronics products.

(Note1) "Renesas Electronics" as used in this document means Renesas Electronics Corporation and also includes its directly or indirectly controlled subsidiaries.

(Note2) "Renesas Electronics product(s)" means any product developed or manufactured by or for Renesas Electronics.

(Rev.4.0-1 November 2017)

Corporate Headquarters

TOYOSU FORESIA, 3-2-24 Toyosu,
Koto-ku, Tokyo 135-0061, Japan
www.renesas.com

Contact Information

For further information on a product, technology, the most up-to-date version of a document, or your nearest sales office, please visit:
www.renesas.com/contact/

Trademarks

Renesas and the Renesas logo are trademarks of Renesas Electronics Corporation. All trademarks and registered trademarks are the property of their respective owners.