



## Device Overview

The 89HPES34H16G2 is a member of the IDT PRECISE™ family of PCI Express® switching solutions. The PES34H16G2 is a 34-lane, 16-port peripheral chip that performs PCI Express packet switching with a feature set optimized for high-performance applications such as servers, storage, and communications/networking. It provides connectivity and switching functions between a PCI Express upstream port and up to fifteen downstream ports and supports switching between downstream ports.

## Features

### ◆ High Performance Non-Blocking Switch Architecture

- 34-lane 16-port PCIe switch
  - Three x8 switch ports each of which can bifurcate to two x4 ports (total of six x4 ports)
  - Ten x1 switch ports
- Integrated SerDes supports 5.0 GT/s Gen2 and 2.5 GT/s Gen1 operation
- Delivers up to 34 GBps (272 Gbps) of switching capacity
- Supports 128 Bytes to 2 KB maximum payload size
- Low latency cut-through architecture
- Supports one virtual channel and eight traffic classes

### ◆ Standards and Compatibility

- PCI Express Base Specification 2.0 compliant
- Implements the following optional PCI Express features
  - Advanced Error Reporting (AER) on all ports
  - End-to-End CRC (ECRC)
  - Access Control Services (ACS)
  - Power Budgeting Enhanced Capability
  - Device Serial Number Enhanced Capability
  - Sub-System ID and Sub-System Vendor ID Capability
  - Internal Error Reporting ECN
  - Multicast ECN
  - VGA and ISA enable
  - L0s and L1 ASPM
  - ARI ECN
- Compatible with IDT 89HPES34H16 PCIe Gen1 switch

### ◆ Port Configurability

- x8, x4, and x1 ports
  - Ability to merge adjacent x4 ports to create a x8 port
- Automatic per port link width negotiation (x8 → x4 → x2 → x1)
- Crosslink support
- Automatic lane reversal

- Autonomous and software managed link width and speed control
- Per lane SerDes configuration
  - De-emphasis
  - Receive equalization
  - Drive strength

### ◆ Switch Partitioning

- IDT proprietary feature that creates logically independent switches in the device
- Supports up to 16 fully independent switch partitions
- Configurable downstream port device numbering
- Supports dynamic reconfiguration of switch partitions
  - Dynamic port reconfiguration (downstream or upstream)
  - Dynamic migration of ports between partitions
  - Movable upstream port within and between switch partitions

### ◆ Initialization / Configuration

- Supports Root (BIOS, OS, or driver), Serial EEPROM, or SMBus switch initialization
- Common switch configurations are supported with pin strapping (no external components)
- Supports in-system Serial EEPROM initialization/programming

### ◆ Quality of Service (QoS)

- Port arbitration
  - Round robin
- Request metering
  - IDT proprietary feature that balances bandwidth among switch ports for maximum system throughput
- High performance switch core architecture
  - Combined Input Output Queued (CIOQ) switch architecture with large buffers

### ◆ Multicast

- Compliant to the PCI-SIG multicast ECN
- Supports arbitrary multicasting of Posted transactions
- Supports 64 multicast groups
- Multicast overlay mechanism support
- ECRC regeneration support

### ◆ Clocking

- Supports 100 MHz and 125 MHz reference clock frequencies
- Flexible clocking modes
  - Common clock
  - Non-common clock

### ◆ Hot-Plug and Hot Swap

- Hot-plug controller on all ports
  - Hot-plug supported on all downstream switch ports

- All ports support hot-plug using low-cost external I<sup>2</sup>C I/O expanders
  - Configurable presence detect supports card and cable applications
  - GPE output pin for hot-plug event notification
    - *Enables SCI/SMI generation for legacy operating system support*
  - Hot-swap capable I/O
  - ◆ **Power Management**
    - Supports D0, D3hot and D3 power management states
    - Active State Power Management (ASPM)
      - *Supports L0, L0s, L1, L2/L3 Ready and L3 link states*
      - *Configurable L0s and L1 entry timers allow performance/power-savings tuning*
    - Supports PCI Express Power Budgeting Capability
    - SerDes power savings
      - *Supports low swing / half-swing SerDes operation*
      - *SerDes optionally turned-off in D3hot*
      - *SerDes associated with unused ports are turned-off*
      - *SerDes associated with unused lanes are placed in a low power state*
  - ◆ **32 General Purpose I/O**
  - ◆ **Reliability, Availability and Serviceability (RAS)**
    - ECRC support
    - AER on all ports
    - SECCDED ECC protection on all internal RAMs
    - End-to-end data path parity protection
    - Checksum Serial EEPROM content protected
    - Autonomous link reliability (preserves system operation in the presence of faulty links)
    - Ability to generate an interrupt (INTx or MSI) on link up/down transitions
  - ◆ **Test and Debug**
    - On-chip link activity and status outputs available for Port 0 (upstream port)
    - Per port link activity and status outputs available using external I<sup>2</sup>C I/O expander for all other ports
    - SerDes test modes
    - Supports IEEE 1149.6 AC JTAG and IEEE 1149.1 JTAG
  - ◆ **Power Supplies**
    - Requires only two power supply voltages (1.0 V and 2.5 V)  
Note that a 3.3V is preferred for V<sub>DD</sub>I/O
    - No power sequencing requirements
  - ◆ **Packaged in a 35mm x 35mm 1156-ball Flip Chip BGA with 1mm ball spacing**
    - Compatible with IDT 89HPES34H16 PCIe Gen1 switch
- Note:** For pin compatibility issues, contact the IDT help desk at [ssdhelp@idt.com](mailto:ssdhelp@idt.com).

## Product Description

Utilizing standard PCI Express interconnect, the PES34H16G2 provides the most efficient I/O connectivity for applications requiring high throughput, low latency, and simple board layout with a minimum number of board layers. It provides 34 GBps (272 Gbps) of aggregated, full-duplex switching capacity through 34 integrated serial lanes, using proven and robust IDT technology. Each lane provides 5 GT/s of bandwidth in both directions and is fully compliant with PCI Express Base Specification, Revision 2.0.

The PES34H16G2 is based on a flexible and efficient layered architecture. The PCI Express layer consists of SerDes, Physical, Data Link and Transaction layers. The PES34H16G2 can operate either as a store and forward switch or a cut-through switch. It supports eight Traffic Classes (TCs) and one Virtual Channel (VC) with sophisticated resource management to enable efficient switching and I/O connectivity.

The PES34H16G2 is a *partitionable* PCIe switch. This means that in addition to operating as a standard PCI express switch, the PES34H16G2 ports may be partitioned into groups that logically operate as completely independent PCIe switches. Figure 2 illustrates a three partition PES34H16G2 configuration.

# Block Diagram

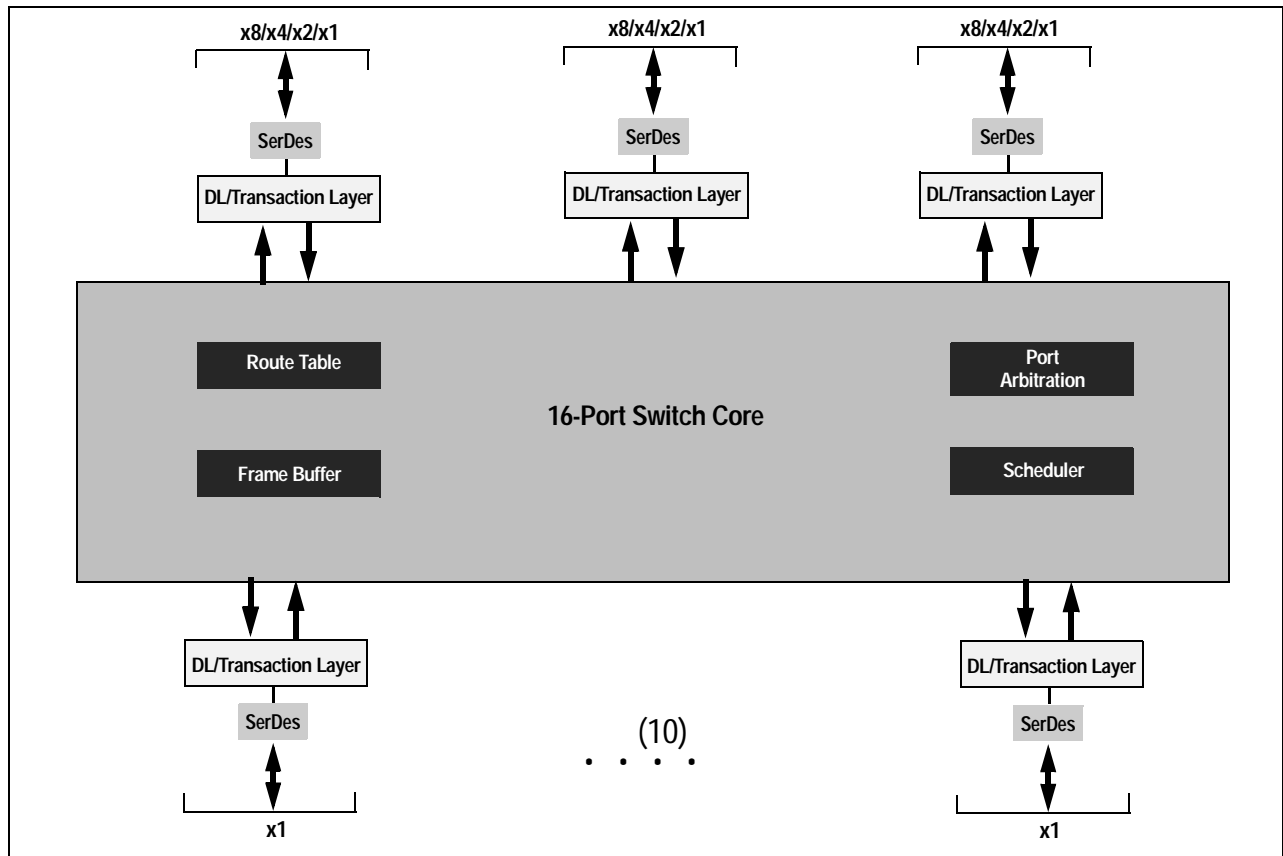

34 PCI Express Lanes  
Up to 6 x4 ports and 10 x1 Ports

Figure 1 PES34H16G2 Block Diagram

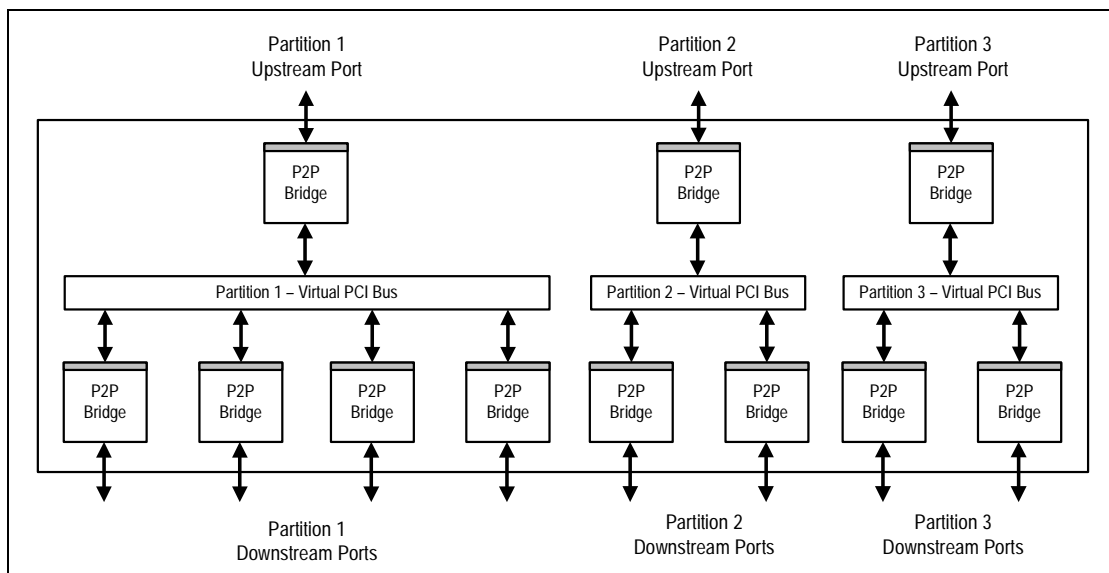

Figure 2 Example of Usage of Switch Partitioning

### SMBus Interface

The PES34H16G2 contains two SMBus interfaces. The slave interface provides full access to the configuration registers in the PES34H16G2, allowing every configuration register in the device to be read or written by an external agent. The master interface allows the default configuration register values of the PES34H16G2 to be overridden following a reset with values programmed in an external serial EEPROM. The master interface is also used by an external Hot-Plug I/O expander.

Six pins make up each of the two SMBus interfaces. These pins consist of an SMBus clock pin, an SMBus data pin, and 4 SMBus address pins. In the slave interface, these address pins allow the SMBus address to which the device responds to be configured. In the master interface, these address pins allow the SMBus address of the serial configuration EEPROM from which data is loaded to be configured. The SMBus address is set up on negation of PERSTN by sampling the corresponding address pins. When the pins are sampled, the resulting address is assigned as shown in Table 1.

Bit	Slave SMBus Address	Master SMBus Address
1	SSMBADDR[1]	MSMBADDR[1]
2	SSMBADDR[2]	MSMBADDR[2]
3	SSMBADDR[3]	MSMBADDR[3]
4	0	MSMBADDR[4]
5	SSMBADDR[5]	1
6	1	0
7	1	1

Table 1 Master and Slave SMBus Address Assignment

As shown in Figure 3, the master and slave SMBuses may only be used in a split configuration.

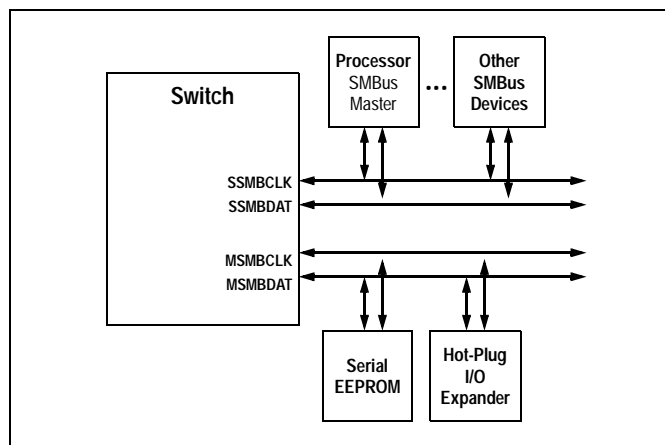

Figure 3 Split SMBus Interface Configuration

The switch's SMBus master interface does not support SMBus arbitration. As a result, the switch's SMBus master must be the only master in the SMBus lines that connect to the serial EEPROM and I/O expander slaves. In the split configuration, the master and slave SMBuses operate as two independent buses; thus, multi-master arbitration is not required.

## Hot-Plug Interface

The PES34H16G2 supports PCI Express Hot-Plug on each downstream port (ports 1 through 15). To reduce the number of pins required on the device, the PES34H16G2 utilizes an external I/O expander, such as that used on PC motherboards, connected to the SMBus master interface. Following reset and configuration, whenever the state of a Hot-Plug output needs to be modified, the PES34H16G2 generates an SMBus transaction to the I/O expander with the new value of all of the outputs. Whenever a Hot-Plug input changes, the I/O expander generates an interrupt which is received on the IOEXPINTN input pin (alternate function of GPIO) of the PES34H16G2. In response to an I/O expander interrupt, the PES34H16G2 generates an SMBus transaction to read the state of all of the Hot-Plug inputs from the I/O expander.

## General Purpose Input/Output

The PES34H16G2 provides 32 General Purpose I/O (GPIO) pins that may be individually configured as general purpose inputs, general purpose outputs, or alternate functions. Some GPIO pins are shared with other on-chip functions. These alternate functions may be enabled via software, SMBus slave interface, or serial configuration EEPROM.

## Pin Description

The following tables list the functions of the pins provided on the PES34H16G2. Some of the functions listed may be multiplexed onto the same pin. The active polarity of a signal is defined using a suffix. Signals ending with an "N" are defined as being active, or asserted, when at a logic zero (low) level. All other signals (including clocks, buses, and select lines) will be interpreted as being active, or asserted, when at a logic one (high) level. Differential signals end with a suffix "N" or "P." The differential signal ending in "P" is the positive portion of the differential pair and the differential signal ending in "N" is the negative portion of the differential pair.

Signal	Type	Name/Description
PE00RN[3:0] PE00RP[3:0]	I	<b>PCI Express Port 0 Serial Data Receive.</b> Differential PCI Express receive pairs for port 0.
PE00TN[3:0] PE00TP[3:0]	O	<b>PCI Express Port 0 Serial Data Transmit.</b> Differential PCI Express transmit pairs for port 0.
PE01RN[3:0] PE01RP[3:0]	I	<b>PCI Express Port 1 Serial Data Receive.</b> Differential PCI Express receive pairs for port 1. When port 0 is merged with port 1, these signals become port 0 receive pairs for lanes 4 through 7.
PE01TN[3:0] PE01TP[3:0]	O	<b>PCI Express Port 1 Serial Data Transmit.</b> Differential PCI Express transmit pairs for port 1. When port 0 is merged with port 1, these signals become port 0 transmit pairs for lanes 4 through 7.
PE02RN[3:0] PE02RP[3:0]	I	<b>PCI Express Port 2 Serial Data Receive.</b> Differential PCI Express receive pairs for port 2.
PE02TN[3:0] PE02TP[3:0]	O	<b>PCI Express Port 2 Serial Data Transmit.</b> Differential PCI Express transmit pairs for port 2.
PE03RN[3:0] PE03RP[3:0]	I	<b>PCI Express Port 3 Serial Data Receive.</b> Differential PCI Express receive pairs for port 3. When port 2 is merged with port 3, these signals become port 2 receive pairs for lanes 4 through 7.
PE03TN[3:0] PE03TP[3:0]	O	<b>PCI Express Port 3 Serial Data Transmit.</b> Differential PCI Express transmit pairs for port 2. When port 2 is merged with port 3, these signals become port 2 transmit pairs for lanes 4 through 7.
PE04RN[3:0] PE04RP[3:0]	I	<b>PCI Express Port 4 Serial Data Receive.</b> Differential PCI Express receive pairs for port 4.
PE04TN[3:0] PE04TP[3:0]	O	<b>PCI Express Port 4 Serial Data Transmit.</b> Differential PCI Express transmit pairs for port 4.
PE05RN[3:0] PE05RP[3:0]	I	<b>PCI Express Port 5 Serial Data Receive.</b> Differential PCI Express receive pairs for port 5. When port 4 is merged with port 5, these signals become port 4 receive pairs for lanes 4 through 7.

Table 2 PCI Express Interface Pins (Part 1 of 2)

Signal	Type	Name/Description
PE05TN[3:0] PE05TP[3:0]	0	<b>PCI Express Port 5 Serial Data Transmit.</b> Differential PCI Express transmit pairs for port 5. When port 4 is merged with port 5, these signals become port 4 transmit pairs for lanes 4 through 7.
PE06RN[0] PE06RP[0]	1	<b>PCI Express Port 6 Serial Data Receive.</b> Differential PCI Express receive pair for port 6.
PE06TN[0] PE06TP[0]	0	<b>PCI Express Port 6 Serial Data Transmit.</b> Differential PCI Express transmit pair for port 6.
PE07RN[0] PE07RP[0]	1	<b>PCI Express Port 7 Serial Data Receive.</b> Differential PCI Express receive pair for port 7.
PE07TN[0] PE07TP[0]	0	<b>PCI Express Port 7 Serial Data Transmit.</b> Differential PCI Express transmit pair for port 7.
PE08RN[0] PE08RP[0]	1	<b>PCI Express Port 8 Serial Data Receive.</b> Differential PCI Express receive pair for port 8.
PE08TN[0] PE08TP[0]	0	<b>PCI Express Port 8 Serial Data Transmit.</b> Differential PCI Express transmit pair for port 8.
PE09RN[0] PE09RP[0]	1	<b>PCI Express Port 9 Serial Data Receive.</b> Differential PCI Express receive pair for port 9.
PE09TN[0] PE09TP[0]	0	<b>PCI Express Port 9 Serial Data Transmit.</b> Differential PCI Express transmit pair for port 9.
PE10RN[0] PE10RP[0]	1	<b>PCI Express Port 10 Serial Data Receive.</b> Differential PCI Express receive pair for port 10.
PE10TN[0] PE10TP[0]	0	<b>PCI Express Port 10 Serial Data Transmit.</b> Differential PCI Express transmit pair for port 10.
PE11RN[0] PE11RP[0]	1	<b>PCI Express Port 11 Serial Data Receive.</b> Differential PCI Express receive pair for port 11.
PE11TN[0] PE11TP[0]	0	<b>PCI Express Port 11 Serial Data Transmit.</b> Differential PCI Express transmit pair for port 11.
PE12RN[0] PE12RP[0]	1	<b>PCI Express Port 12 Serial Data Receive.</b> Differential PCI Express receive pair for port 12.
PE12TN[0] PE12TP[0]	0	<b>PCI Express Port 12 Serial Data Transmit.</b> Differential PCI Express transmit pair for port 12.
PE13RN[0] PE13RP[0]	1	<b>PCI Express Port 13 Serial Data Receive.</b> Differential PCI Express receive pair for port 13.
PE13TN[0] PE13TP[0]	0	<b>PCI Express Port 13 Serial Data Transmit.</b> Differential PCI Express transmit pair for port 13. W
PE14RN[0] PE14RP[0]	1	<b>PCI Express Port 14 Serial Data Receive.</b> Differential PCI Express receive pair for port 14.
PE14TN[0] PE14TP[0]	0	<b>PCI Express Port 14 Serial Data Transmit.</b> Differential PCI Express transmit pair for port 14.
PE15RN[0] PE15RP[0]	1	<b>PCI Express Port 15 Serial Data Receive.</b> Differential PCI Express receive pair for port 15.
PE15TN[0] PE15TP[0]	0	<b>PCI Express Port 15 Serial Data Transmit.</b> Differential PCI Express transmit pair for port 15.

Table 2 PCI Express Interface Pins (Part 2 of 2)

Signal	Type	Name/Description
GCLKN[1:0] GCLKP[1:0]	I	<b>Global Reference Clock.</b> Differential reference clock input pair. This clock is used as the reference clock by on-chip PLLs to generate the clocks required for the system logic. The frequency of the differential reference clock is determined by the GCLKFSEL signal.

Table 3 Reference Clock Pins

Signal	Type	Name/Description
MSMBADDR[4:1]	I	<b>Master SMBus Address.</b> These pins determine the SMBus address of the serial EEPROM from which configuration information is loaded.
MSMBCLK	I/O	<b>Master SMBus Clock.</b> This bidirectional signal is used to synchronize transfers on the master SMBus. It is active and generating the clock only when the EEPROM or I/O Expanders are being accessed.
MSMBDAT	I/O	<b>Master SMBus Data.</b> This bidirectional signal is used for data on the master SMBus.
SSMBADDR[5,3:1]	I	<b>Slave SMBus Address.</b> These pins determine the SMBus address to which the slave SMBus interface responds.
SSMBCLK	I/O	<b>Slave SMBus Clock.</b> This bidirectional signal is used to synchronize transfers on the slave SMBus.
SSMBDAT	I/O	<b>Slave SMBus Data.</b> This bidirectional signal is used for data on the slave SMBus.

Table 4 SMBus Interface Pins

Signal	Type	Name/Description
GPIO[0]	I/O	General Purpose I/O. This pin can be configured as a general purpose I/O pin. Alternate function pin name: PART0PERSTN Alternate function pin type: Input/Output Alternate function: Assertion of this signal initiated a partition fundamental reset in the corresponding partition.
GPIO[1]	I/O	General Purpose I/O. This pin can be configured as a general purpose I/O pin. Alternate function pin name: PART1PERSTN Alternate function pin type: Input/Output Alternate function: Assertion of this signal initiated a partition fundamental reset in the corresponding partition.
GPIO[2]	I/O	General Purpose I/O. This pin can be configured as a general purpose I/O pin. Alternate function pin name: PART2PERSTN Alternate function pin type: Input/Output Alternate function: Assertion of this signal initiated a partition fundamental reset in the corresponding partition.
GPIO[3]	I/O	General Purpose I/O. This pin can be configured as a general purpose I/O pin. Alternate function pin name: PART3PERSTN Alternate function pin type: Input/Output Alternate function: Assertion of this signal initiated a partition fundamental reset in the corresponding partition.

Table 5 General Purpose I/O Pins (Part 1 of 5)

Signal	Type	Name/Description
GPIO[4]	I	General Purpose I/O. This pin can be configured as a general purpose I/O pin. 1st Alternate function — Reserved 2nd Alternate function pin name: P0LINKUPN 2nd Alternate function pin type: Output 2nd Alternate function: Port 0 Link Up Status output.
GPIO[5]	O	General Purpose I/O. This pin can be configured as a general purpose I/O pin. 1st Alternate function pin name: GPEN 1st Alternate function pin type: Output 1st Alternate function: Hot-plug general purpose even output. 2nd Alternate function pin name: P0ACTIVEN 2nd Alternate function pin type: Output 2nd Alternate function: Port 0 Link Active Status Output.
GPIO[6]	I	General Purpose I/O. This pin can be configured as a general purpose I/O pin.
GPIO[7]	I/O	General Purpose I/O. This pin can be configured as a general purpose I/O pin.
GPIO[8]	I	General Purpose I/O. This pin can be configured as a general purpose I/O pin. Alternate function pin name: IOEXPINTN Alternate function pin type: Input Alternate function: IO expander interrupt.
GPIO[9]	I	General Purpose I/O. This pin can be configured as a general purpose I/O pin. Alternate function pin name: HP0APN Alternate function pin type: Input Alternate function: Hot Plug Signal Group 0 Attention Push Button Input.
GPIO[10]	I	General Purpose I/O. This pin can be configured as a general purpose I/O pin. Alternate function pin name: HP0PDN Alternate function pin type: Input Alternate function: Hot Plug Signal Group 0 Presence Detect Input.
GPIO[11]	I	General Purpose I/O. This pin can be configured as a general purpose I/O pin. Alternate function pin name: HP0PFN Alternate function pin type: Input Alternate function: Hot Plug Signal Group 0 Power Fault Input.
GPIO[12]	I	General Purpose I/O. This pin can be configured as a general purpose I/O pin. Alternate function pin name: HP0PWRGDN Alternate function pin type: Input Alternate function: Hot Plug Signal Group 0 Power Good Input.
GPIO[13]	I	General Purpose I/O. This pin can be configured as a general purpose I/O pin. Alternate function pin name: HP0MRLN Alternate function pin type: Input Alternate function: Hot Plug Signal Group 0 Manually Operated Retention latch Input.
GPIO[14]	O	General Purpose I/O. This pin can be configured as a general purpose I/O pin. Alternate function pin name: HP0AIN Alternate function pin type: Output Alternate function: Hot Plug Signal Group 0 Attention Indicator Output.

Table 5 General Purpose I/O Pins (Part 2 of 5)



Signal	Type	Name/Description
GPIO[15]	0	General Purpose I/O. This pin can be configured as a general purpose I/O pin. Alternate function pin name: HP0PIN Alternate function pin type: Output Alternate function: Hot Plug Signal Group 0 Power Indicator Output.
GPIO[16]	0	General Purpose I/O. This pin can be configured as a general purpose I/O pin. Alternate function pin name: HP0PEP Alternate function pin type: Output Alternate function: Hot Plug Signal Group 0 Power Enable Output.
GPIO[17]	0	General Purpose I/O. This pin can be configured as a general purpose I/O pin. Alternate function pin name: HP0RSTN Alternate function pin type: Output Alternate function: Hot Plug Signal Group 0 Reset Output.
GPIO[18]	1	General Purpose I/O. This pin can be configured as a general purpose I/O pin. Alternate function pin name: HP1APN Alternate function pin type: Input Alternate function: Hot Plug Signal Group 1 Attention Push Button Input.
GPIO[19]	1	General Purpose I/O. This pin can be configured as a general purpose I/O pin. Alternate function pin name: HP1PDN Alternate function pin type: Input Alternate function: Hot Plug Signal Group 1 Presence Detect Input.
GPIO[20]	1	General Purpose I/O. This pin can be configured as a general purpose I/O pin. Alternate function pin name: HP1PFN Alternate function pin type: Input Alternate function: Hot Plug Signal Group 1 Power Fault Input.
GPIO[21]	1	General Purpose I/O. This pin can be configured as a general purpose I/O pin. Alternate function pin name: HP1PWRGDN Alternate function pin type: Input Alternate function: Hot Plug Signal Group 1 Power Good Input.
GPIO[22]	I/O	General Purpose I/O. This pin can be configured as a general purpose I/O pin. 1st Alternate function pin name: HP1MRLN 1st Alternate function pin type: Input 1st Alternate function: Hot Plug Signal Group 1 Manually Operated Retention. 2nd Alternate function pin name: P1LINKUPN 2nd Alternate function pin type: Output 2nd Alternate function: Port 1 Link Up Status Output.
GPIO[23]	0	General Purpose I/O. This pin can be configured as a general purpose I/O pin. 1st Alternate function pin name: HP1AIN 1st Alternate function pin type: Output 1st Alternate function: Hot Plug Signal Group 1 Attention Indicator Output. 2nd Alternate function pin name: P1ACTIVEN 2nd Alternate function pin type: Output 2nd Alternate function: Port 1 Link Active Status Output.

Table 5 General Purpose I/O Pins (Part 3 of 5)

Signal	Type	Name/Description
GPIO[24]	O	General Purpose I/O. This pin can be configured as a general purpose I/O pin. 1st Alternate function pin name: HP1PIN 1st Alternate function pin type: Output 1st Alternate function: Hot Plug Signal Group 1 Power Indicator Output. 2nd Alternate function pin name: P2LINKUPN 2nd Alternate function pin type: Output 2nd Alternate function: Port 2 Link Up Status Output.
GPIO[25]	O	General Purpose I/O. This pin can be configured as a general purpose I/O pin. 1st Alternate function pin name: HP1PEP 1st Alternate function pin type: Output 1st Alternate function: Hot Plug Signal Group 1 Power Enable Output. 2nd Alternate function pin name: P2ACTIVEN 2nd Alternate function pin type: Output 2nd Alternate function: Port 2 Link Active Status Output.
GPIO[26]	O	General Purpose I/O. This pin can be configured as a general purpose I/O pin. 1st Alternate function pin name: HP1RSTN 1st Alternate function pin type: Output 1st Alternate function: Hot Plug Signal Group 1 Reset Output. 2nd Alternate function pin name: P3LINKUPN 2nd Alternate function pin type: Output 2nd Alternate function: Port 3 Link Up Status Output.
GPIO[27]	I/O	General Purpose I/O. This pin can be configured as a general purpose I/O pin. 1st Alternate function pin name: HP2APN 1st Alternate function pin type: Input 1st Alternate function: Hot Plug Signal Group 2 Attention Push Button Input. 2nd Alternate function pin name: P3ACTIVEN 2nd Alternate function pin type: Output 2nd Alternate function: Port 3 Link Active Status Output.
GPIO[28]	I/O	General Purpose I/O. This pin can be configured as a general purpose I/O pin. 1st Alternate function pin name: HP2PDN 1st Alternate function pin type: Input 1st Alternate function: Hot Plug Signal Group 0 Presence Detect Input. 2nd Alternate function pin name: P4LINKUPN 2nd Alternate function pin type: Output 2nd Alternate function: Port 4 Link Up Status Output.

Table 5 General Purpose I/O Pins (Part 4 of 5)

Signal	Type	Name/Description
GPIO[29]	I/O	General Purpose I/O. This pin can be configured as a general purpose I/O pin. 1st Alternate function pin name: HP2PFN 1st Alternate function pin type: Input 1st Alternate function: Hot Plug Signal Group 2 Power Fault Input. 2nd Alternate function pin name: P4ACTIVEN 2nd Alternate function pin type: Output 2nd Alternate function: Port 4 Link Active Status Output.
GPIO[30]	I/O	General Purpose I/O. This pin can be configured as a general purpose I/O pin. 1st Alternate function pin name: HP2PWRGDN 1st Alternate function pin type: Input 1st Alternate function: Hot Plug Signal Group 2 Power Good Input. 2nd Alternate function pin name: P5LINKUPN 2nd Alternate function pin type: Output 2nd Alternate function: Port 5 Link Up Status Output.
GPIO[31]	I/O	General Purpose I/O. This pin can be configured as a general purpose I/O pin. 1st Alternate function pin name: HP2MRLN 1st Alternate function pin type: Input 1st Alternate function: Hot Plug Signal Group 2 Manually Operated Retention Latch Input. 2nd Alternate function pin name: P5ACTIVEN 2nd Alternate function pin type: Output 2nd Alternate function: Port 5 Link Active Status Output.

Table 5 General Purpose I/O Pins (Part 5 of 5)

Signal	Type	Name/Description
CLKMODE[1:0]		<b>Clock Mode.</b> These signals determine the port clocking mode used by ports of the device.
GCLKFSEL	I	<b>Global Clock Frequency Select.</b> These signals select the frequency of the GCLKP and GCLKN signals. 0x0 100 MHz 0x1 125 MHz
MSMBSMODE	I	<b>Master SMBus Slow Mode.</b> The assertion of this pin indicates that the master SMBus should operate at 100 KHz instead of 400 KHz. This value may not be overridden.
P01MERGEN	I	<b>Port 0 and 1 Merge.</b> P01MERGEN is an active low signal. It is pulled low internally. When this pin is low, port 0 is merged with port 1 to form a single x8 port. The Serdes lanes associated with port 1 become lanes 4 through 7 of port 0. When this pin is high, port 0 and port 1 are not merged, and each operates as a single x4 port.
P23MERGEN	I	<b>Port 2 and 3 Merge.</b> P23MERGEN is an active low signal. It is pulled low internally. When this pin is low, port 2 is merged with port 3 to form a single x8 port. The Serdes lanes associated with port 3 become lanes 4 through 7 of port 2. When this pin is high, port 2 and port 3 are not merged, and each operates as a single x4 port.
P45MERGEN	I	<b>Port 4 and 5 Merge.</b> P45MERGEN is an active low signal. It is pulled low internally. When this pin is low, port 4 is merged with port 5 to form a single x8 port. The Serdes lanes associated with port 5 become lanes 4 through 7 of port 4. When this pin is high, port 4 and port 5 are not merged, and each operates as a single x4 port.

Table 6 System Pins (Part 1 of 2)

Signal	Type	Name/Description
PERSTN	I	<b>Fundamental Reset.</b> Assertion of this signal resets all logic inside the PES34H16G2 and initiates a PCI Express fundamental reset.
RSTHALT	I	<b>Reset Halt.</b> When this signal is asserted during a PCI Express fundamental reset, the PES34H16G2 executes the reset procedure and remains in a reset state with the Master and Slave SMBuses active. This allows software to read and write registers internal to the device before normal device operation begins. The device exits the reset state when the RSTHALT bit is cleared in the PA_SWCTL register by an SMBus master.
SWMODE[3:0]	I	<b>Switch Mode.</b> These configuration pins determine the PES34H16G2 switch operating mode. <b>Note:</b> These pins should be static and not change following the negation of PERSTN. 0x0 - Single partition 0x1 - Single partition with Serial EEPROM initialization 0x2 through 0x7 - Reserved 0x8 - Single partition with port 0 selected as the upstream port (port 2 disabled) 0x9 - Single partition with port 2 selected as the upstream port (port 0 disabled) 0xA - Single partition with Serial EEPROM initialization and port 0 selected as the upstream port (port 2 disabled) 0xB - Single partition with Serial EEPROM initialization and port 2 selected as the upstream port (port 0 disabled) 0xC - Multi-partition 0xD - Multi-partition with Serial EEPROM initialization 0xE - Reserved 0xF - Reserved

Table 6 System Pins (Part 2 of 2)

Signal	Type	Name/Description
JTAG_TCK	I	<b>JTAG Clock.</b> This is an input test clock used to clock the shifting of data into or out of the boundary scan logic or JTAG Controller. JTAG_TCK is independent of the system clock with a nominal 50% duty cycle.
JTAG_TDI	I	<b>JTAG Data Input.</b> This is the serial data input to the boundary scan logic or JTAG Controller.
JTAG_TDO	O	<b>JTAG Data Output.</b> This is the serial data shifted out from the boundary scan logic or JTAG Controller. When no data is being shifted out, this signal is tri-stated.
JTAG_TMS	I	<b>JTAG Mode.</b> The value on this signal controls the test mode select of the boundary scan logic or JTAG Controller.
JTAG_TRST_N	I	<b>JTAG Reset.</b> This active low signal asynchronously resets the boundary scan logic and JTAG TAP Controller. An external pull-up on the board is recommended to meet the JTAG specification in cases where the tester can access this signal. However, for systems running in functional mode, one of the following should occur: 1) actively drive this signal low with control logic 2) statically drive this signal low with an external pull-down on the board

Table 7 Test Pins

Signal	Type	Name/Description
REFRES00	I/O	<b>Port 0 External Reference Resistor.</b> Provides a reference for the Port 0 SerDes bias currents and PLL calibration circuitry. A 3 kOhm +/- 1% resistor should be connected from this pin to ground.
REFRES01	I/O	<b>Port 1 External Reference Resistor.</b> Provides a reference for the Port 1 SerDes bias currents and PLL calibration circuitry. A 3 kOhm +/- 1% resistor should be connected from this pin to ground.
REFRES02	I/O	<b>Port 2 External Reference Resistor.</b> Provides a reference for the Port 2 SerDes bias currents and PLL calibration circuitry. A 3 kOhm +/- 1% resistor should be connected from this pin to ground.
REFRES30	I/O	<b>Port 3 External Reference Resistor.</b> Provides a reference for the Port 3 SerDes bias currents and PLL calibration circuitry. A 3 kOhm +/- 1% resistor should be connected from this pin to ground.
REFRES04	I/O	<b>Port 4 External Reference Resistor.</b> Provides a reference for the Port 4 SerDes bias currents and PLL calibration circuitry. A 3 kOhm +/- 1% resistor should be connected from this pin to ground.
REFRES05	I/O	<b>Port 5 External Reference Resistor.</b> Provides a reference for the Port 5 SerDes bias currents and PLL calibration circuitry. A 3 kOhm +/- 1% resistor should be connected from this pin to ground.
REFRES06	I/O	<b>Port 6 External Reference Resistor.</b> Provides a reference for the Port 6 SerDes bias currents and PLL calibration circuitry. A 3 kOhm +/- 1% resistor should be connected from this pin to ground.
REFRES07	I/O	<b>Port 7 External Reference Resistor.</b> Provides a reference for the Port 7 SerDes bias currents and PLL calibration circuitry. A 3 kOhm +/- 1% resistor should be connected from this pin to ground.
REFRES08	I/O	<b>Port 8 External Reference Resistor.</b> Provides a reference for the Port 8 SerDes bias currents and PLL calibration circuitry. A 3 kOhm +/- 1% resistor should be connected from this pin to ground.
REFRES09	I/O	<b>Port 9 External Reference Resistor.</b> Provides a reference for the Port 9 SerDes bias currents and PLL calibration circuitry. A 3 kOhm +/- 1% resistor should be connected from this pin to ground.
REFRES10	I/O	<b>Port 10 External Reference Resistor.</b> Provides a reference for the Port 10 SerDes bias currents and PLL calibration circuitry. A 3 kOhm +/- 1% resistor should be connected from this pin to ground.
REFRES11	I/O	<b>Port 11 External Reference Resistor.</b> Provides a reference for the Port 11 SerDes bias currents and PLL calibration circuitry. A 3 kOhm +/- 1% resistor should be connected from this pin to ground.
REFRES12	I/O	<b>Port 12 External Reference Resistor.</b> Provides a reference for the Port 12 SerDes bias currents and PLL calibration circuitry. A 3 kOhm +/- 1% resistor should be connected from this pin to ground.
REFRES13	I/O	<b>Port 13 External Reference Resistor.</b> Provides a reference for the Port 13 SerDes bias currents and PLL calibration circuitry. A 3 kOhm +/- 1% resistor should be connected from this pin to ground.
REFRES14	I/O	<b>Port 14 External Reference Resistor.</b> Provides a reference for the Port 14 SerDes bias currents and PLL calibration circuitry. A 3 kOhm +/- 1% resistor should be connected from this pin to ground.

Table 8 Power, Ground, and SerDes Resistor Pins (Part 1 of 2)

Signal	Type	Name/Description
REFRES15	I/O	<b>Port 15 External Reference Resistor.</b> Provides a reference for the Port 15 SerDes bias currents and PLL calibration circuitry. A 3 kOhm +/- 1% resistor should be connected from this pin to ground.
REFRESPLL	I/O	<b>PLL External Reference Resistor.</b> Provides a reference for the PLL bias currents and PLL calibration circuitry. A 3K Ohm +/- 1% resistor should be connected from this pin to ground.
V <sub>DD</sub> CORE	I	<b>Core V<sub>DD</sub>.</b> Power supply for core logic (1.0V).
V <sub>DD</sub> I/O	I	<b>I/O V<sub>DD</sub>.</b> LVTTTL I/O buffer power supply (2.5V or preferred 3.3V).
V <sub>DD</sub> PEA	I	<b>PCI Express Analog Power.</b> Serdes analog power supply (1.0V).
V <sub>DD</sub> PEHA	I	<b>PCI Express Analog High Power.</b> Serdes analog power supply (2.5V).
V <sub>DD</sub> PETA	I	<b>PCI Express Transmitter Analog Voltage.</b> Serdes transmitter analog power supply (1.0V).
V <sub>SS</sub>	I	<b>Ground.</b>

Table 8 Power, Ground, and SerDes Resistor Pins (Part 2 of 2)

## Pin Characteristics

**Note:** Some input pads of the switch do not contain internal pull-ups or pull-downs. Unused SMBus and System inputs should be tied off to appropriate levels. This is especially critical for unused control signal inputs which, if left floating, could adversely affect operation. Also, floating pins can cause a slight increase in power consumption. Unused Serdes (Rx and Tx) pins should be left floating. Finally, No Connection pins should not be connected.

Function	Pin Name	Type	Buffer	I/O Type	Internal Resistor <sup>1</sup>	Notes
PCI Express Interface	PE00RN[3:0]	I	PCIe differential <sup>2</sup>	Serial Link		
	PE00RP[3:0]	I				
	PE00TN[3:0]	O				
	PE00TP[3:0]	O				
	PE01RN[3:0]	I				
	PE01RP[3:0]	I				
	PE01TN[3:0]	O				
	PE01TP[3:0]	O				
	PE02RN[3:0]	I				
	PE02RP[3:0]	I				
	PE02TN[3:0]	O				
	PE02TP[3:0]	O				
	PE03RN[3:0]	I				
	PE03RP[3:0]	I				
	PE03TN[3:0]	O				
	PE03TP[3:0]	O				
	PE04RN[3:0]	I				
	PE04RP[3:0]	I				
	PE04TN[3:0]	O				
	PE04TP[3:0]	O				
	PE05RN[3:0]	I				
	PE05RP[3:0]	I				
	PE05TN[3:0]	O				
	PE05TP[3:0]	O				
	PE06RN[0]	I				
	PE06RP[0]	I				
	PE06TN[0]	O				
	PE06TP[0]	O				
	PE07RN[0]	I				
	PE07RP[0]	I				
	PE07TN[0]	O				
	PE07TP[0]	O				
PE08RN[0]	I					

Table 9 Pin Characteristics (Part 1 of 4)

Function	Pin Name	Type	Buffer	I/O Type	Internal Resistor <sup>1</sup>	Notes
PCI Express Interface (cont.)	PE08RP[0]	I	PCIe differential	Serial Link		
	PE08TN[0]	O				
	PE08TP[0]	O				
	PE09RN[0]	I				
	PE09RP[0]	I				
	PE09TN[0]	O				
	PE09TP[0]	O				
	PE10RN[0]	I				
	PE10RP[0]	I				
	PE10TN[0]	O				
	PE10TP[0]	O				
	PE11RN[0]	I				
	PE11RP[0]	I				
	PE11TN[0]	O				
	PE11TP[0]	O				
	PE12RN[0]	I				
	PE12RP[0]	I				
	PE12TN[0]	O				
	PE12TP[0]	O				
	PE13RN[0]	I				
	PE13RP[0]	I				
	PE13TN[0]	O				
	PE13TP[0]	O				
	PE14RN[0]	I				
	PE14RP[0]	I				
	PE14TN[0]	O				
	PE14TP[0]	O				
	PE15RN[0]	I				
	PE15RP[0]	I				
	PE15TN[0]	O				
PE15TP[0]	O					
	GCLKN[1:0]	I	HCSL	Diff. Clock Input		Refer to Table 10
	GCLKP[1:0]	I				

Table 9 Pin Characteristics (Part 2 of 4)



Function	Pin Name	Type	Buffer	I/O Type	Internal Resistor <sup>1</sup>	Notes
SMBus	MSMBADDR[4:1]	I	LVTTTL		pull-down	
	MSMBCLK	I/O		STI <sup>3</sup>		
	MSMBDAT	I/O		STI		
	SSMBADDR[5,3:1]	I			pull-up	
	SSMBCLK	I/O		STI		
	SSMBDAT	I/O		STI		
General Purpose I/O	GPIO[31:0]	I/O	LVTTTL		pull-up	
System Pins	CLKMODE[1:0]	I	LVTTTL	Input	pull-up	
	GCLKFSEL	I			pull-down	
	MSMBSMODE	I			pull-down	
	P01MERGEN	I			pull-down	
	P23MERGEN	I			pull-down	
	P45MERGEN	I			pull-down	
	PERSTN	I		STI		
	RSTHALT	I		Input	pull-down	
	SWMODE[3:0]	I		pull-down		
EJTAG / JTAG	JTAG_TCK	I	LVTTTL	STI	pull-up	
	JTAG_TDI	I		STI	pull-up	
	JTAG_TDO	O				
	JTAG_TMS	I		STI	pull-up	
	JTAG_TRST_N	I		STI	pull-up	External pull-down
SerDes Reference Resistors	REFRES00	I/O	Analog			
	REFRES01	I/O				
	REFRES02	I/O				
	REFRES03	I/O				
	REFRES04	I/O				
	REFRES05	I/O				
	REFRES06	I/O				
	REFRES07	I/O				
	REFRES08	I/O				
	REFRES09	I/O				
	REFRES10	I/O				
	REFRES11	I/O				
	REFRES12	I/O				
	REFRES13	I/O				

Table 9 Pin Characteristics (Part 3 of 4)

Function	Pin Name	Type	Buffer	I/O Type	Internal Resistor <sup>1</sup>	Notes
SerDes Reference Resistors (Cont.)	REFRES14	I/O	Analog			
	REFRES15	I/O				
	REFRESPLL	I/O				

**Table 9 Pin Characteristics (Part 4 of 4)**

- <sup>1</sup>. Internal resistor values under typical operating conditions are 92K  $\Omega$  for pull-up and 91K  $\Omega$  for pull-down.
- <sup>2</sup>. All receiver pins set the DC common mode voltage to ground. All transmitters must be AC coupled to the media.
- <sup>3</sup>. Schmitt Trigger Input (STI).

Logic Diagram — PES34H16G2

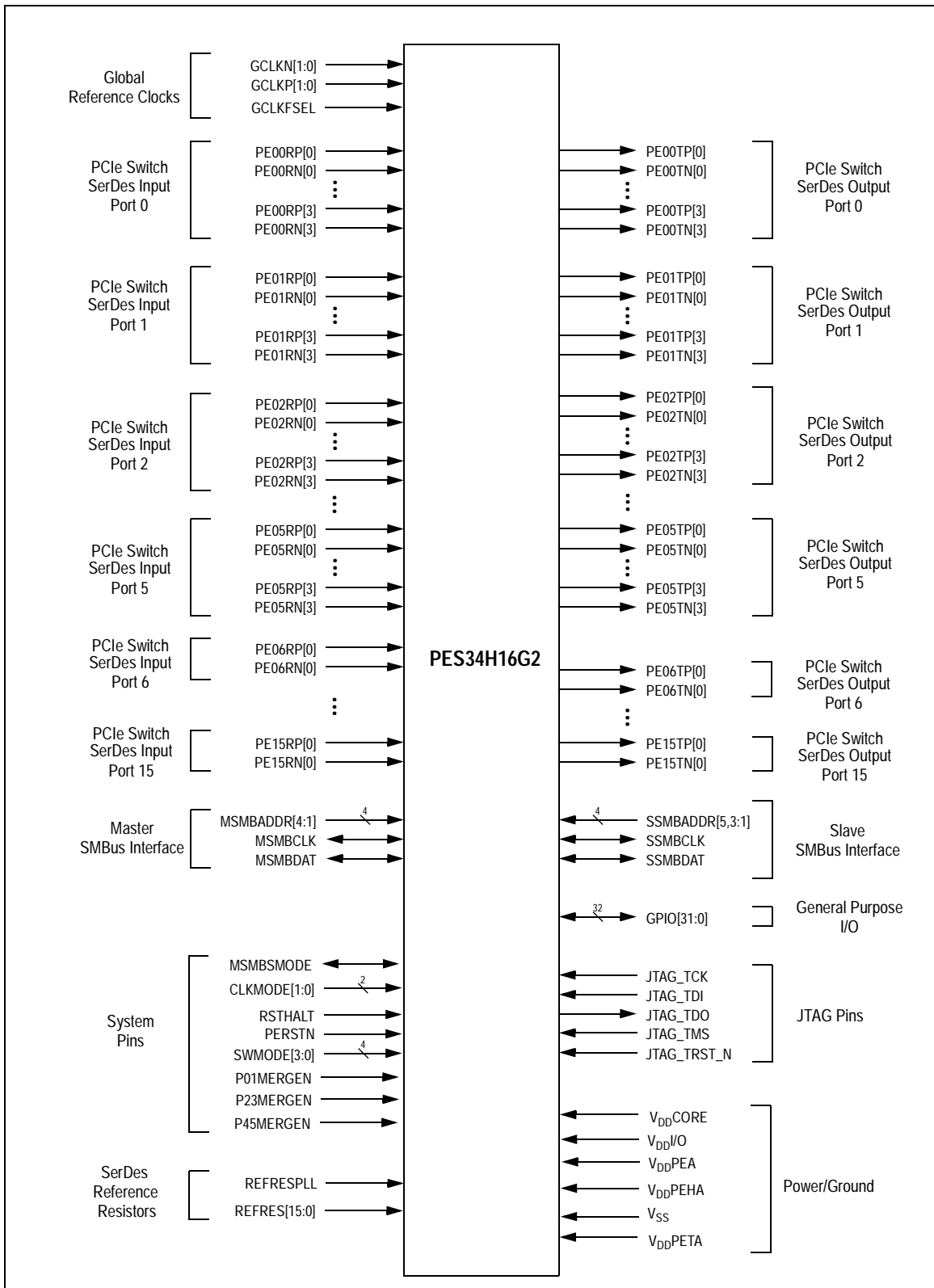

Figure 4 PES34H16G2 Logic Diagram

## System Clock Parameters

Values based on systems running at recommended supply voltages and operating temperatures, as shown in Tables 14 and 15.

Parameter	Description	Condition	Min	Typical	Max	Unit
Refclk <sub>FREQ</sub>	Input reference clock frequency range		100		125 <sup>1</sup>	MHz
T <sub>C-RISE</sub>	Rising edge rate	Differential	0.6		4	V/ns
T <sub>C-FALL</sub>	Falling edge rate	Differential	0.6		4	V/ns
V <sub>IH</sub>	Differential input high voltage	Differential	+150			mV
V <sub>IL</sub>	Differential input low voltage	Differential			-150	mV
V <sub>CROSS</sub>	Absolute single-ended crossing point voltage	Single-ended	+250		+550	mV
V <sub>CROSS-DELTA</sub>	Variation of V <sub>CROSS</sub> over all rising clock edges	Single-ended			+140	mV
V <sub>RB</sub>	Ring back voltage margin	Differential	-100		+100	mV
T <sub>STABLE</sub>	Time before V <sub>RB</sub> is allowed	Differential	500			ps
T <sub>PERIOD-AVG</sub>	Average clock period accuracy		-300		2800	ppm
T <sub>PERIOD-ABS</sub>	Absolute period, including spread-spectrum and jitter		9.847		10.203	ns
T <sub>CC-JITTER</sub>	Cycle to cycle jitter				150	ps
V <sub>MAX</sub>	Absolute maximum input voltage				+1.15	V
V <sub>MIN</sub>	Absolute minimum input voltage		-0.3			V
Duty Cycle	Duty cycle		40		60	%
Rise/Fall Matching	Single ended rising Refclk edge rate versus falling Refclk edge rate			20		%
Z <sub>C-DC</sub>	Clock source output DC impedance		40		60	Ω

**Table 10 Input Clock Requirements**

<sup>1</sup> The input clock frequency will be either 100 or 125 MHz depending on signal GCLKFSEL.

## AC Timing Characteristics

Parameter	Description	Gen 1			Gen 2			Units
		Min <sup>1</sup>	Typ <sup>1</sup>	Max <sup>1</sup>	Min <sup>1</sup>	Typ <sup>1</sup>	Max <sup>1</sup>	
PCIe Transmit								
UI	Unit Interval	399.88	400	400.12	199.94	200	200.06	ps
T <sub>TX-EYE</sub>	Minimum Tx Eye Width	0.75			0.75			UI
T <sub>TX-EYE-MEDIAN-to-MAX-JITTER</sub>	Maximum time between the jitter median and maximum deviation from the median			0.125				UI
T <sub>TX-RISE</sub> , T <sub>TX-FALL</sub>	TX Rise/Fall Time: 20% - 80%	0.125			0.15			UI
T <sub>TX-IDLE-MIN</sub>	Minimum time in idle	20			20			UI

**Table 11 PCIe AC Timing Characteristics (Part 1 of 2)**

Parameter	Description	Gen 1			Gen 2			Units
		Min <sup>1</sup>	Typ <sup>1</sup>	Max <sup>1</sup>	Min <sup>1</sup>	Typ <sup>1</sup>	Max <sup>1</sup>	
T <sub>TX-IDLE-SET-TO-IDLE</sub>	Maximum time to transition to a valid Idle after sending an Idle ordered set			8			8	ns
T <sub>TX-IDLE-TO-DIFF-DATA</sub>	Maximum time to transition from valid idle to diff data			8			8	ns
T <sub>TX-SKEW</sub>	Transmitter data skew between any 2 lanes			1.3			1.3	ns
T <sub>MIN-PULSED</sub>	Minimum Instantaneous Lone Pulse Width	NA			0.9			UI
T <sub>TX-HF-DJ-DD</sub>	Transmitter Deterministic Jitter > 1.5MHz Bandwidth	NA					0.15	UI
T <sub>RF-MISMATCH</sub>	Rise/Fall Time Differential Mismatch	NA					0.1	UI
PCIe Receive								
UI	Unit Interval	399.88	400	400.12	199.94		200.06	ps
T <sub>RX-EYE (with jitter)</sub>	Minimum Receiver Eye Width (jitter tolerance)	0.4			0.4			UI
T <sub>RX-EYE-MEDIUM TO MAX JITTER</sub>	Max time between jitter median & max deviation			0.3				UI
T <sub>RX-SKEW</sub>	Lane to lane input skew			20			8	ns
T <sub>RX-HF-RMS</sub>	1.5 — 100 MHz RMS jitter (common clock)	NA					3.4	ps
T <sub>RX-HF-DJ-DD</sub>	Maximum tolerable DJ by the receiver (common clock)	NA					88	ps
T <sub>RX-LF-RMS</sub>	10 KHz to 1.5 MHz RMS jitter (common clock)	NA					4.2	ps
T <sub>RX-MIN-PULSE</sub>	Minimum receiver instantaneous eye width	NA			0.6			UI

Table 11 PCIe AC Timing Characteristics (Part 2 of 2)

<sup>1</sup> Minimum, Typical, and Maximum values meet the requirements under PCI Specification 2.0

Signal	Symbol	Reference Edge	Min	Max	Unit	Timing Diagram Reference
<b>GPIO</b>						
GPIO[31:0] <sup>1</sup>	Tpw_13b <sup>2</sup>	None	50	—	ns	See Figure 5.

Table 12 GPIO AC Timing Characteristics

<sup>1</sup> GPIO signals must meet the setup and hold times if they are synchronous or the minimum pulse width if they are asynchronous.

<sup>2</sup> The values for this symbol were determined by calculation, not by testing.

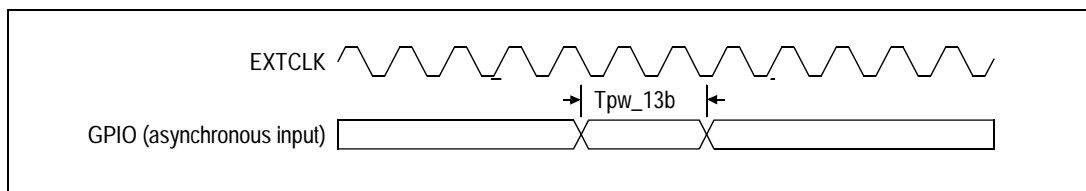

Figure 5 GPIO AC Timing Waveform

Signal	Symbol	Reference Edge	Min	Max	Unit	Timing Diagram Reference
<b>JTAG</b>						
JTAG_TCK	Tper_16a	none	50.0	—	ns	See Figure 6.
	Thigh_16a, Tlow_16a		10.0	25.0	ns	
JTAG_TMS <sup>1</sup> , JTAG_TDI	Tsu_16b	JTAG_TCK rising	2.4	—	ns	
	Thld_16b		1.0	—	ns	
JTAG_TDO	Tdo_16c	JTAG_TCK falling	—	20	ns	
	Tdz_16c <sup>2</sup>		—	20	ns	
JTAG_TRST_N	Tpw_16d <sup>2</sup>	none	25.0	—	ns	

**Table 13 JTAG AC Timing Characteristics**

<sup>1</sup>: The JTAG specification, IEEE 1149.1, recommends that JTAG\_TMS should be held at 1 while the signal applied at JTAG\_TRST\_N changes from 0 to 1. Otherwise, a race may occur if JTAG\_TRST\_N is deasserted (going from low to high) on a rising edge of JTAG\_TCK when JTAG\_TMS is low, because the TAP controller might go to either the Run-Test/Idle state or stay in the Test-Logic-Reset state.

<sup>2</sup>: The values for this symbol were determined by calculation, not by testing.

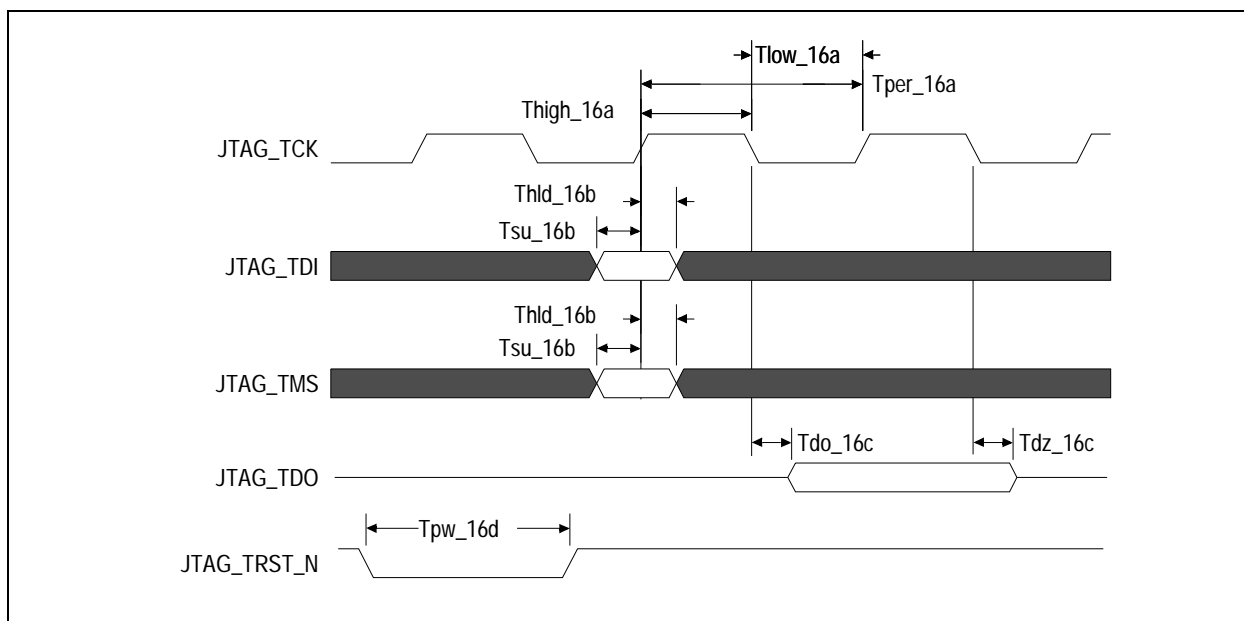

**Figure 6 JTAG AC Timing Waveform**

## Recommended Operating Supply Voltages

Symbol	Parameter	Minimum	Typical	Maximum	Unit
$V_{DDCORE}$	Internal logic supply	0.9	1.0	1.1	V
$V_{DDI/O}$	I/O supply except for SerDes	2.25	2.5	2.75	V
		3.125	3.3	3.465	V
$V_{DDPEA}^1$	PCI Express Analog Power	0.95	1.0	1.1	V
$V_{DDPEHA}^2$	PCI Express Analog High Power	2.25	2.5	2.75	V
$V_{DDPETA}^1$	PCI Express Transmitter Analog Voltage	0.95	1.0	1.1	V
$V_{SS}$	Common ground	0	0	0	V

**Table 14 PES34H16G2 Operating Voltages**

<sup>1</sup>  $V_{DDPEA}$  and  $V_{DDPETA}$  should have no more than 25mV<sub>peak-peak</sub> AC power supply noise superimposed on the 1.0V nominal DC value.

<sup>2</sup>  $V_{DDPEHA}$  should have no more than 50mV<sub>peak-peak</sub> AC power supply noise superimposed on the 2.5V nominal DC value.

## Power-Up/Power-Down Sequence

During power supply ramp-up,  $V_{DDCORE}$  must remain at least 1.0V below  $V_{DDI/O}$  at all times. There are no other power-up sequence requirements for the various operating supply voltages.

The power-down sequence can occur in any order.

## Recommended Operating Temperature

Grade	Temperature
Commercial	0°C to +70°C Ambient
Industrial	-40°C to +85°C Ambient

**Table 15 PES34H16G2 Operating Temperatures**

## Power Consumption

Typical power is measured under the following conditions: 25°C Ambient, 35% total link usage on all ports, typical voltages defined in Table 14 (and also listed below).

Maximum power is measured under the following conditions: 70°C Ambient, 85% total link usage on all ports, maximum voltages defined in Table 14 (and also listed below).

Number of active Lanes per Port		Core Supply		PCIe Digital Supply		PCIe Analog Supply		PCIe Transmitter Supply		I/O Supply		Total	
		Typ 1.0V	Max 1.1V	Typ 1.0V	Max 1.1V	Typ 2.5V	Max 2.75V	Typ 1.0V	Max 1.1V	Typ 2.5V	Max 2.75V	Typ Power	Max Power
Three x8 and ten x1 (Full Swing)	<b>mA</b>	3630	6264	1741	2049	805	818	1060	1117	32	40		
	<b>Watts</b>	3.63	6.89	1.74	2.25	2.01	2.25	1.06	1.23	0.08	0.11	8.52	12.73
Three x8 and ten x1 (Half Swing)	<b>mA</b>	3630	6264	1497	1762	805	818	551	581	32	40		
	<b>Watts</b>	3.63	6.89	1.50	1.94	2.01	2.25	0.55	0.64	0.08	0.11	7.77	11.83

Table 16 PES34H16G2 Power Consumption — 2.5V I/O

Number of active Lanes per Port		Core Supply		PCIe Digital Supply		PCIe Analog Supply		PCIe Transmitter Supply		I/O Supply		Total	
		Typ 1.0V	Max 1.1V	Typ 1.0V	Max 1.1V	Typ 2.5V	Max 2.75V	Typ 1.0V	Max 1.1V	Typ 3.3V	Max 3.465V	Typ Power	Max Power
Three x8 and ten x1 (Full Swing)	<b>mA</b>	3630	6264	1741	2049	805	818	1060	1117	36	46		
	<b>Watts</b>	3.63	6.89	1.74	2.25	2.01	2.25	1.06	1.23	0.12	0.16	8.56	12.78
Three x8 and ten x1 (Half Swing)	<b>mA</b>	3630	6264	1497	1762	805	818	551	581	36	46		
	<b>Watts</b>	3.63	6.89	1.50	1.94	2.01	2.25	0.55	0.64	0.12	0.16	7.81	11.88

Table 17 PES34H16G2 Power Consumption — 3.3V I/O

**Note 1:** I/O supply of 3.3V is preferred.

**Note 2:** The above power consumption assumes that all ports are functioning at Gen2 (5.0 GT/S) speeds. Power consumption can be reduced by turning off unused ports through software or through boot EEPROM. Power savings will occur in  $V_{DDPEA}$ ,  $V_{DDPEHA}$ , and  $V_{DDPETA}$ . Power savings can be estimated as directly proportional to the number of unused ports, since the power consumption of a turned-off port is close to zero. For example, if 3 ports out of 16 are turned off, then the power savings for each of the above three power rails can be calculated quite simply as 3/16 multiplied by the power consumption indicated in the above table.

**Note 3:** Using a port in Gen1 mode (2.5GT/S) results in approximately 18% power savings for each power rail:  $V_{DDPEA}$ ,  $V_{DDPEHA}$ , and  $V_{DDPETA}$ .



## Thermal Considerations

This section describes thermal considerations for the PES34H16G2 (35X35<sup>2</sup> FCBGA1156 package). The data in Table 18 below contains information that is relevant to the thermal performance of the PES34H16G2 switch.

Symbol	Parameter	Value	Units	Conditions
$T_{J(max)}$	Junction Temperature	125	°C	Maximum
$T_{A(max)}$	Ambient Temperature	70	°C	Maximum for commercial-rated products
		85	°C	Maximum for industrial-rated products
$\theta_{JA(effective)}$	Effective Thermal Resistance, Junction-to-Ambient	13.0	°C/W	Zero air flow
		6.8	°C/W	1 m/S air flow
		5.8	°C/W	2 m/S air flow
$\theta_{JB}$	Thermal Resistance, Junction-to-Board	2.5	°C/W	
$\theta_{JC}$	Thermal Resistance, Junction-to-Case	0.15	°C/W	
P	Power Dissipation of the Device	12.78	Watts	Maximum

**Table 18 Thermal Specifications for PES34H16G2, 35x35mm FCBGA1156 Package**

**Note:** It is important for the reliability of this device in any user environment that the junction temperature not exceed the  $T_{J(max)}$  value specified in Table 18. Consequently, the effective junction to ambient thermal resistance ( $\theta_{JA}$ ) for the worst case scenario must be maintained below the value determined by the formula:

$$\theta_{JA} = (T_{J(max)} - T_{A(max)})/P$$

Given that the values of  $T_{J(max)}$ ,  $T_{A(max)}$ , and P are known, the value of desired  $\theta_{JA}$  becomes a known entity to the system designer. How to achieve the desired  $\theta_{JA}$  is left up to the board or system designer, but in general, it can be achieved by adding the effects of  $\theta_{JC}$  (value provided in Table 18), thermal resistance of the chosen adhesive ( $\theta_{CS}$ ), that of the heat sink ( $\theta_{SA}$ ), amount of airflow, and properties of the circuit board (number of layers and size of the board). It is strongly recommended that users perform their own thermal analysis for their own board and system design scenarios.

## DC Electrical Characteristics

Values based on systems running at recommended supply voltages, as shown in Table 14.

**Note:** See Table 9, Pin Characteristics, for a complete I/O listing.

I/O Type	Parameter	Description	Gen1			Gen2			Unit	Condi- tions
			Min <sup>1</sup>	Typ <sup>1</sup>	Max <sup>1</sup>	Min <sup>1</sup>	Typ <sup>1</sup>	Max <sup>1</sup>		
Serial Link	PCIe Transmit									
	$V_{TX-DIFFp-p}$	Differential peak-to-peak output voltage	800		1200	800		1200	mV	
	$V_{TX-DIFFp-p-LOW}$	Low-Drive Differential Peak to Peak Output Voltage	400		1200	400		1200	mV	
	$V_{TX-DE-RATIO-3.5dB}$	De-emphasized differential output voltage	-3		-4	-3.0	-3.5	-4.0	dB	
	$V_{TX-DE-RATIO-6.0dB}$	De-emphasized differential output voltage	NA			-5.5	-6.0	-6.5	dB	
	$V_{TX-DC-CM}$	DC Common mode voltage	0		3.6	0		3.6	V	
	$V_{TX-CM-ACP}$	RMS AC peak common mode output voltage			20				mV	
	$V_{TX-CM-DC-active-idle-delta}$	Abs delta of DC common mode voltage between LO and idle			100			100	mV	
	$V_{TX-CM-DC-line-delta}$	Abs delta of DC common mode voltage between D+ and D-			25			25	mV	
	$V_{TX-Idle-DiffP}$	Electrical idle diff peak output			20			20	mV	
	$RL_{TX-DIFF}$	Transmitter Differential Return loss	10					10	dB	0.05 - 1.25GHz
									8	dB
	$RL_{TX-CM}$	Transmitter Common Mode Return loss	6					6	dB	
	$Z_{TX-DIFF-DC}$	DC Differential TX impedance	80	100	120			120	$\Omega$	
	$V_{TX-CM-ACpp}$	Peak-Peak AC Common	NA					100	mV	
	$V_{TX-DC-CM}$	Transmit Driver DC Common Mode Voltage	0		3.6	0		3.6	V	
$V_{TX-RCV-DETECT}$	The amount of voltage change allowed during Receiver Detection			600			600	mV		
$I_{TX-SHORT}$	Transmitter Short Circuit Current Limit	0		90				90	mA	

Table 19 DC Electrical Characteristics (Part 1 of 2)

I/O Type	Parameter	Description	Gen1			Gen2			Unit	Condi- tions
			Min <sup>1</sup>	Typ <sup>1</sup>	Max <sup>1</sup>	Min <sup>1</sup>	Typ <sup>1</sup>	Max <sup>1</sup>		
Serial Link (cont.)	PCIe Receive									
	$V_{RX-DIFFp-p}$	Differential input voltage (peak-to-peak)	175		1200	120		1200	mV	
	$RL_{RX-DIFF}$	Receiver Differential Return Loss	10					10	dB	0.05 - 1.25GHz
								8		1.25 - 2.5GHz
	$RL_{RX-CM}$	Receiver Common Mode Return Loss	6					6	dB	
	$Z_{RX-DIFF-DC}$	Differential input impedance (DC)	80	100	120	Refer to return loss spec			$\Omega$	
	$Z_{RX--DC}$	DC common mode impedance	40	50	60	40		60	$\Omega$	
	$Z_{RX-COMM-DC}$	Powered down input common mode impedance (DC)	200k	350k				50k	$\Omega$	
	$Z_{RX-HIGH-IMP-DC-POS}$	DC input CM input impedance for $V > 0$ during reset or power down			50k			50k	$\Omega$	
	$Z_{RX-HIGH-IMP-DC-NEG}$	DC input CM input impedance for $V < 0$ during reset or power down			1.0k			1.0k	$\Omega$	
$V_{RX-IDLE-DET-DIFFp-p}$	Electrical idle detect threshold	65		175	65		175	mV		
$V_{RX-CM-ACp}$	Receiver AC common-mode peak voltage			150			150	mV	$V_{RX-CM-ACp}$	
PCIe REFCLK										
	$C_{IN}$	Input Capacitance	1.5	—		1.5	—		pF	
Other I/Os										
LOW Drive Output	$I_{OL}$		—	2.5	—	—	2.5	—	mA	$V_{OL} = 0.4v$
	$I_{OH}$		—	-5.5	—	—	-5.5	—	mA	$V_{OH} = 1.5V$
High Drive Output	$I_{OL}$		—	12.0	—	—	12.0	—	mA	$V_{OL} = 0.4v$
	$I_{OH}$		—	-20.0	—	—	-20.0	—	mA	$V_{OH} = 1.5V$
Schmitt Trig- ger Input (STI)	$V_{IL}$		-0.3	—	0.8	-0.3	—	0.8	V	—
	$V_{IH}$		2.0	—	$V_{DD}/O + 0.5$	2.0	—	$V_{DD}/O + 0.5$	V	—
Input	$V_{IL}$		-0.3	—	0.8	-0.3	—	0.8	V	—
	$V_{IH}$		2.0	—	$V_{DD}/O + 0.5$	2.0	—	$V_{DD}/O + 0.5$	V	—
Capacitance	$C_{IN}$		—	—	8.5	—	—	8.5	pF	—
Leakage	Inputs		—	—	$\pm 10$	—	—	$\pm 10$	$\mu A$	$V_{DD}/O$ (max)
	$I/O_{LEAK}$ W/O Pull-ups/downs		—	—	$\pm 10$	—	—	$\pm 10$	$\mu A$	$V_{DD}/O$ (max)
	$I/O_{LEAK}$ WITH Pull-ups/downs		—	—	$\pm 80$	—	—	$\pm 80$	$\mu A$	$V_{DD}/O$ (max)

Table 19 DC Electrical Characteristics (Part 2 of 2)

<sup>1</sup> Minimum, Typical, and Maximum values meet the requirements under PCI Specification 2.0.

## Absolute Maximum Voltage Rating

Core Supply	PCIe Analog Supply	PCIe Analog High Supply	PCIe Transmitter Supply	I/O Supply
1.5V	1.5V	4.6V	1.5V	4.6V

Table 20 PES34H16G2 Absolute Maximum Voltage Rating

**Warning:** For proper and reliable operation in adherence with this data sheet, the device should not exceed the recommended operating voltages in Table 14. The absolute maximum operating voltages in Table 20 are offered to provide guidelines for voltage excursions outside the recommended voltage ranges. Device functionality is not guaranteed at these conditions and sustained operation at these values or any exposure to voltages outside the maximum range may adversely affect device functionality and reliability.

## SMBus Characterization

Symbol	Parameter	SMBus 2.0 Char. Data <sup>1</sup>			Unit
		3V	3.3V	3.6V	
<b>DC Parameter for SDA Pin</b>					
V <sub>IL</sub>	Input Low	1.16	1.26	1.35	V
V <sub>IH</sub>	Input High	1.56	1.67	1.78	V
V <sub>OL@350uA</sub>	Output Low	15	15	15	mV
I <sub>OL@0.4V</sub>		23	24	25	mA
I <sub>Pullup</sub>	Current Source	—	—	—	μA
I <sub>IL_Leak</sub>	Input Low Leakage	0	0	0	μA
I <sub>IH_Leak</sub>	Input High Leakage	0	0	0	μA
<b>DC Parameter for SCL Pin</b>					
V <sub>IL (V)</sub>	Input Low	1.11	1.2	1.31	V
V <sub>IH (V)</sub>	Input High	1.54	1.65	1.76	V
I <sub>IL_Leak</sub>	Input Low Leakage	0	0	0	μA
I <sub>IH_Leak</sub>	Input High Leakage	0	0	0	μA

Table 21 SMBus DC Characterization Data

<sup>1</sup> Data at room and hot temperature.

Symbol	Parameter	SMBus @3.3V $\pm 10\%$ <sup>1</sup>		Unit
		Min	Max	
F <sub>SCL</sub>	Clock frequency	5	600	KHz
T <sub>BUF</sub>	Bus free time between Stop and Start	3.5	—	$\mu$ s
T <sub>HD:STA</sub>	Start condition hold time	1	—	$\mu$ s
T <sub>SU:STA</sub>	Start condition setup time	1	—	$\mu$ s
T <sub>SU:STO</sub>	Stop condition setup time	1	—	$\mu$ s
T <sub>HD:DAT</sub>	Data hold time	1	—	ns
T <sub>SU:DAT</sub>	Data setup time	1	—	ns
T <sub>TIMEOUT</sub>	Detect clock low time out	—	74.7	ms
T <sub>LOW</sub>	Clock low period	3.7	—	$\mu$ s
T <sub>HIGH</sub>	Clock high period	3.7	—	$\mu$ s
T <sub>F</sub>	Clock/Data fall time	—	72.2	ns
T <sub>R</sub>	Clock/Data rise time	—	68.3	ns
T <sub>POR@10kHz</sub>	Time which a device must be operational after power-on reset	20	—	ms

Table 22 SMBus AC Timing Data

<sup>1</sup>. Data at room and hot temperature.

## Package Pinout — 1156-BGA Signal Pinout for the PES34H16G2

The following table lists the pin numbers and signal names for the PES34H16G2 device. Note: Pins labeled NC are No Connect.

Pin	Function	Alt	Pin	Function	Alt	Pin	Function	Alt	Pin	Function	Alt
A1	V <sub>SS</sub>		B1	V <sub>SS</sub>		C1	GPIO_29	2	D1	GPIO_28	2
A2	V <sub>SS</sub>		B2	V <sub>DD</sub> /O		C2	GPIO_27	2	D2	GPIO_26	2
A3	GPIO_19	1	B3	GPIO_18	1	C3	GPIO_21	1	D3	V <sub>DD</sub> /O	
A4	V <sub>DD</sub> /O		B4	GPIO_17	1	C4	GPIO_16	1	D4	GPIO_23	2
A5	V <sub>SS</sub>		B5	V <sub>SS</sub>		C5	V <sub>SS</sub>		D5	V <sub>SS</sub>	
A6	NC		B6	NC		C6	V <sub>SS</sub>		D6	NC	
A7	NC		B7	NC		C7	V <sub>SS</sub>		D7	NC	
A8	V <sub>SS</sub>		B8	V <sub>SS</sub>		C8	V <sub>SS</sub>		D8	V <sub>SS</sub>	
A9	NC		B9	NC		C9	V <sub>SS</sub>		D9	NC	
A10	PE09TP0		B10	PE09TN0		C10	V <sub>SS</sub>		D10	PE09RN0	
A11	V <sub>SS</sub>		B11	V <sub>SS</sub>		C11	V <sub>SS</sub>		D11	V <sub>SS</sub>	
A12	NC		B12	NC		C12	V <sub>SS</sub>		D12	NC	
A13	NC		B13	NC		C13	V <sub>SS</sub>		D13	NC	
A14	V <sub>SS</sub>		B14	V <sub>SS</sub>		C14	V <sub>SS</sub>		D14	V <sub>SS</sub>	
A15	NC		B15	NC		C15	V <sub>SS</sub>		D15	NC	
A16	PE08TP0		B16	PE08TN0		C16	V <sub>SS</sub>		D16	PE08RN0	
A17	V <sub>SS</sub>		B17	V <sub>SS</sub>		C17	V <sub>SS</sub>		D17	V <sub>SS</sub>	
A18	PE03TP3		B18	PE03TN3		C18	V <sub>SS</sub>		D18	PE03RN3	
A19	PE03TP2		B19	PE03TN2		C19	V <sub>SS</sub>		D19	PE03RN2	
A20	V <sub>SS</sub>		B20	V <sub>SS</sub>		C20	V <sub>SS</sub>		D20	V <sub>SS</sub>	
A21	PE03TP1		B21	PE03TN1		C21	V <sub>SS</sub>		D21	PE03RN1	
A22	PE03TP0		B22	PE03TN0		C22	V <sub>SS</sub>		D22	PE03RN0	
A23	V <sub>SS</sub>		B23	V <sub>SS</sub>		C23	V <sub>SS</sub>		D23	V <sub>SS</sub>	
A24	PE02TP3		B24	PE02TN3		C24	V <sub>SS</sub>		D24	PE02RN3	
A25	PE02TP2		B25	PE02TN2		C25	V <sub>SS</sub>		D25	PE02RN2	
A26	V <sub>SS</sub>		B26	V <sub>SS</sub>		C26	V <sub>SS</sub>		D26	V <sub>SS</sub>	
A27	PE02TP1		B27	PE02TN1		C27	V <sub>SS</sub>		D27	PE02RN1	
A28	PE02TP0		B28	PE02TN0		C28	V <sub>SS</sub>		D28	PE02RN0	
A29	V <sub>SS</sub>		B29	V <sub>SS</sub>		C29	V <sub>SS</sub>		D29	V <sub>SS</sub>	
A30	V <sub>DD</sub> /O		B30	MSMBADDR3		C30	MSMBADDR4		D30	JTAG_TMS	
A31	MSMBADDR1		B31	MSMBADDR2		C31	JTAG_TDI		D31	V <sub>DD</sub> /O	
A32	MSMBSMODE		B32	PERSTN		C32	JTAG_TRST_N		D32	SSMBADDR5	
A33	V <sub>SS</sub>		B33	V <sub>DD</sub> /O		C33	SSMBADDR2		D33	SSMBADDR3	
A34	V <sub>SS</sub>		B34	V <sub>SS</sub>		C34	SSMBADDR1		D34	V <sub>DD</sub> /O	

Table 23 PES34H16G2 Signal Pin-Out (Part 1 of 9)

Pin	Function	Alt	Pin	Function	Alt	Pin	Function	Alt	Pin	Function	Alt
E1	V <sub>DD</sub> I/O		F1	V <sub>SS</sub>		G1	PE10TP0		H1	NC	
E2	GPIO_30	2	F2	V <sub>SS</sub>		G2	PE10TN0		H2	NC	
E3	GPIO_31	2	F3	V <sub>SS</sub>		G3	V <sub>SS</sub>		H3	V <sub>SS</sub>	
E4	GPIO_24	2	F4	V <sub>SS</sub>		G4	PE10RN0		H4	NC	
E5	V <sub>SS</sub>		F5	V <sub>SS</sub>		G5	PE10RP0		H5	NC	
E6	NC		F6	V <sub>SS</sub>		G6	V <sub>SS</sub>		H6	V <sub>SS</sub>	
E7	NC		F7	V <sub>SS</sub>		G7	V <sub>SS</sub>		H7	V <sub>SS</sub>	
E8	V <sub>SS</sub>		F8	V <sub>SS</sub>		G8	V <sub>SS</sub>		H8	GPIO_20	1
E9	NC		F9	V <sub>SS</sub>		G9	V <sub>SS</sub>		H9	V <sub>DD</sub> I/O	
E10	PE09RP0		F10	REFRES09		G10	V <sub>SS</sub>		H10	V <sub>SS</sub>	
E11	V <sub>SS</sub>		F11	V <sub>SS</sub>		G11	V <sub>SS</sub>		H11	V <sub>SS</sub>	
E12	NC		F12	V <sub>SS</sub>		G12	NC		H12	V <sub>SS</sub>	
E13	NC		F13	V <sub>SS</sub>		G13	V <sub>SS</sub>		H13	V <sub>DD</sub> PEHA	
E14	V <sub>SS</sub>		F14	V <sub>SS</sub>		G14	V <sub>SS</sub>		H14	V <sub>SS</sub>	
E15	NC		F15	V <sub>SS</sub>		G15	NC		H15	V <sub>DD</sub> PETA	
E16	PE08RP0		F16	V <sub>SS</sub>		G16	V <sub>SS</sub>		H16	V <sub>SS</sub>	
E17	V <sub>SS</sub>		F17	REFRESPLL		G17	GCLKN0		H17	V <sub>SS</sub>	
E18	PE03RP3		F18	V <sub>SS</sub>		G18	GCLKP0		H18	V <sub>SS</sub>	
E19	PE03RP2		F19	REFRES03		G19	NC		H19	V <sub>SS</sub>	
E20	V <sub>SS</sub>		F20	V <sub>SS</sub>		G20	V <sub>SS</sub>		H20	V <sub>DD</sub> PETA	
E21	PE03RP1		F21	V <sub>SS</sub>		G21	V <sub>SS</sub>		H21	REFRES02	
E22	PE03RP0		F22	V <sub>SS</sub>		G22	NC		H22	V <sub>DD</sub> PEHA	
E23	V <sub>SS</sub>		F23	V <sub>SS</sub>		G23	V <sub>SS</sub>		H23	V <sub>SS</sub>	
E24	PE02RP3		F24	V <sub>SS</sub>		G24	V <sub>SS</sub>		H24	V <sub>SS</sub>	
E25	PE02RP2		F25	V <sub>SS</sub>		G25	V <sub>SS</sub>		H25	V <sub>SS</sub>	
E26	V <sub>SS</sub>		F26	V <sub>SS</sub>		G26	V <sub>SS</sub>		H26	MSMBDAT	
E27	PE02RP1		F27	V <sub>SS</sub>		G27	MSMBCLK		H27	V <sub>DD</sub> I/O	
E28	PE02RP0		F28	V <sub>SS</sub>		G28	V <sub>SS</sub>		H28	SSMBCLK	
E29	V <sub>SS</sub>		F29	V <sub>SS</sub>		G29	V <sub>SS</sub>		H29	V <sub>SS</sub>	
E30	V <sub>SS</sub>		F30	PE01RP3		G30	PE01RP2		H30	V <sub>SS</sub>	
E31	V <sub>SS</sub>		F31	PE01RN3		G31	PE01RN2		H31	V <sub>SS</sub>	
E32	V <sub>SS</sub>		F32	V <sub>SS</sub>		G32	V <sub>SS</sub>		H32	V <sub>SS</sub>	
E33	V <sub>SS</sub>		F33	PE01TN3		G33	PE01TN2		H33	V <sub>SS</sub>	
E34	V <sub>SS</sub>		F34	PE01TP3		G34	PE01TP2		H34	V <sub>SS</sub>	

Table 23 PES34H16G2 Signal Pin-Out (Part 2 of 9)

Pin	Function	Alt	Pin	Function	Alt	Pin	Function	Alt	Pin	Function	Alt
J1	V <sub>SS</sub>		K1	NC		L1	NC		M1	V <sub>SS</sub>	
J2	V <sub>SS</sub>		K2	NC		L2	NC		M2	V <sub>SS</sub>	
J3	V <sub>SS</sub>		K3	V <sub>SS</sub>		L3	V <sub>SS</sub>		M3	V <sub>SS</sub>	
J4	V <sub>SS</sub>		K4	NC		L4	NC		M4	V <sub>SS</sub>	
J5	V <sub>SS</sub>		K5	NC		L5	NC		M5	V <sub>SS</sub>	
J6	V <sub>SS</sub>		K6	V <sub>SS</sub>		L6	V <sub>SS</sub>		M6	V <sub>SS</sub>	
J7	V <sub>SS</sub>		K7	V <sub>SS</sub>		L7	V <sub>SS</sub>		M7	V <sub>SS</sub>	
J8	V <sub>SS</sub>		K8	V <sub>SS</sub>		L8	V <sub>SS</sub>		M8	V <sub>SS</sub>	
J9	GPIO_25	2	K9	V <sub>DD</sub> I/O		L9	V <sub>SS</sub>		M9	V <sub>SS</sub>	
J10	V <sub>SS</sub>		K10	GPIO_22	2	L10	V <sub>SS</sub>		M10	V <sub>SS</sub>	
J11	V <sub>SS</sub>		K11	V <sub>SS</sub>		L11	V <sub>SS</sub>		M11	V <sub>SS</sub>	
J12	V <sub>SS</sub>		K12	V <sub>SS</sub>		L12	V <sub>SS</sub>		M12	V <sub>SS</sub>	
J13	V <sub>SS</sub>		K13	V <sub>DD</sub> PEHA		L13	V <sub>DD</sub> PEA		M13	V <sub>DD</sub> PEA	
J14	V <sub>DD</sub> PEA		K14	V <sub>SS</sub>		L14	V <sub>DD</sub> PEA		M14	V <sub>SS</sub>	
J15	REFRES08		K15	V <sub>DD</sub> PETA		L15	V <sub>DD</sub> PEA		M15	V <sub>DD</sub> PEA	
J16	V <sub>SS</sub>		K16	V <sub>SS</sub>		L16	V <sub>SS</sub>		M16	V <sub>SS</sub>	
J17	V <sub>DD</sub> PEHA		K17	V <sub>DD</sub> PEHA		L17	V <sub>DD</sub> PEA		M17	V <sub>DD</sub> PEA	
J18	V <sub>DD</sub> PEHA		K18	V <sub>DD</sub> PEHA		L18	V <sub>DD</sub> PEA		M18	V <sub>DD</sub> PEA	
J19	V <sub>SS</sub>		K19	V <sub>SS</sub>		L19	V <sub>SS</sub>		M19	V <sub>SS</sub>	
J20	V <sub>SS</sub>		K20	V <sub>DD</sub> PETA		L20	V <sub>DD</sub> PEA		M20	V <sub>DD</sub> PEA	
J21	V <sub>DD</sub> PEA		K21	V <sub>SS</sub>		L21	V <sub>DD</sub> PEA		M21	V <sub>SS</sub>	
J22	V <sub>SS</sub>		K22	V <sub>DD</sub> PEHA		L22	V <sub>DD</sub> PEA		M22	V <sub>DD</sub> PEA	
J23	V <sub>SS</sub>		K23	V <sub>SS</sub>		L23	V <sub>SS</sub>		M23	V <sub>SS</sub>	
J24	V <sub>SS</sub>		K24	V <sub>SS</sub>		L24	V <sub>SS</sub>		M24	V <sub>SS</sub>	
J25	JTAG_TDO		K25	CLKMODE1		L25	V <sub>SS</sub>		M25	V <sub>SS</sub>	
J26	V <sub>DD</sub> I/O		K26	JTAG_TCK		L26	V <sub>SS</sub>		M26	V <sub>SS</sub>	
J27	SSMBDAT		K27	V <sub>SS</sub>		L27	V <sub>SS</sub>		M27	V <sub>SS</sub>	
J28	V <sub>SS</sub>		K28	V <sub>SS</sub>		L28	V <sub>SS</sub>		M28	REFRES01	
J29	V <sub>SS</sub>		K29	V <sub>SS</sub>		L29	V <sub>SS</sub>		M29	V <sub>SS</sub>	
J30	PE01RP1		K30	PE01RP0		L30	V <sub>SS</sub>		M30	PE00RP3	
J31	PE01RN1		K31	PE01RN0		L31	V <sub>SS</sub>		M31	PE00RN3	
J32	V <sub>SS</sub>		K32	V <sub>SS</sub>		L32	V <sub>SS</sub>		M32	V <sub>SS</sub>	
J33	PE01TN1		K33	PE01TN0		L33	V <sub>SS</sub>		M33	PE00TN3	
J34	PE01TP1		K34	PE01TP0		L34	V <sub>SS</sub>		M34	PE00TP3	

Table 23 PES34H16G2 Signal Pin-Out (Part 3 of 9)



Pin	Function	Alt	Pin	Function	Alt	Pin	Function	Alt	Pin	Function	Alt
N1	PE11TP0		P1	NC		R1	V <sub>SS</sub>		T1	NC	
N2	PE11TN0		P2	NC		R2	V <sub>SS</sub>		T2	NC	
N3	V <sub>SS</sub>		P3	V <sub>SS</sub>		R3	V <sub>SS</sub>		T3	V <sub>SS</sub>	
N4	PE11RN0		P4	NC		R4	V <sub>SS</sub>		T4	NC	
N5	PE11RP0		P5	NC		R5	V <sub>SS</sub>		T5	NC	
N6	V <sub>SS</sub>		P6	V <sub>SS</sub>		R6	V <sub>SS</sub>		T6	NC	
N7	NC		P7	V <sub>SS</sub>		R7	REFRES10		T7	V <sub>SS</sub>	
N8	V <sub>DD</sub> PEHA		P8	V <sub>SS</sub>		R8	V <sub>DD</sub> PETA		T8	V <sub>SS</sub>	
N9	V <sub>SS</sub>		P9	V <sub>DD</sub> PEA		R9	V <sub>SS</sub>		T9	REFRES11	
N10	V <sub>DD</sub> PEHA		P10	V <sub>SS</sub>		R10	V <sub>DD</sub> PETA		T10	V <sub>SS</sub>	
N11	V <sub>DD</sub> PEA		P11	V <sub>DD</sub> PEA		R11	V <sub>DD</sub> PEA		T11	V <sub>SS</sub>	
N12	V <sub>DD</sub> PEA		P12	V <sub>SS</sub>		R12	V <sub>DD</sub> PEA		T12	V <sub>SS</sub>	
N13	V <sub>DD</sub> CORE		P13	V <sub>DD</sub> CORE		R13	V <sub>DD</sub> CORE		T13	V <sub>SS</sub>	
N14	V <sub>DD</sub> CORE		P14	V <sub>SS</sub>		R14	V <sub>DD</sub> CORE		T14	V <sub>SS</sub>	
N15	V <sub>DD</sub> CORE		P15	V <sub>DD</sub> CORE		R15	V <sub>SS</sub>		T15	V <sub>DD</sub> CORE	
N16	V <sub>SS</sub>		P16	V <sub>SS</sub>		R16	V <sub>DD</sub> CORE		T16	V <sub>SS</sub>	
N17	V <sub>DD</sub> CORE		P17	V <sub>DD</sub> CORE		R17	V <sub>SS</sub>		T17	V <sub>DD</sub> CORE	
N18	V <sub>SS</sub>		P18	V <sub>SS</sub>		R18	V <sub>DD</sub> CORE		T18	V <sub>SS</sub>	
N19	V <sub>DD</sub> CORE		P19	V <sub>DD</sub> CORE		R19	V <sub>SS</sub>		T19	V <sub>DD</sub> CORE	
N20	V <sub>DD</sub> CORE		P20	V <sub>SS</sub>		R20	V <sub>DD</sub> CORE		T20	V <sub>SS</sub>	
N21	V <sub>DD</sub> CORE		P21	V <sub>DD</sub> CORE		R21	V <sub>SS</sub>		T21	V <sub>DD</sub> CORE	
N22	V <sub>DD</sub> CORE		P22	V <sub>DD</sub> CORE		R22	V <sub>DD</sub> CORE		T22	V <sub>DD</sub> CORE	
N23	V <sub>DD</sub> PEA		P23	V <sub>SS</sub>		R23	V <sub>DD</sub> PEA		T23	V <sub>SS</sub>	
N24	V <sub>DD</sub> PEA		P24	V <sub>DD</sub> PEA		R24	V <sub>DD</sub> PEA		T24	V <sub>SS</sub>	
N25	V <sub>DD</sub> PEHA		P25	V <sub>SS</sub>		R25	V <sub>DD</sub> PETA		T25	V <sub>SS</sub>	
N26	V <sub>SS</sub>		P26	V <sub>DD</sub> PEA		R26	V <sub>SS</sub>		T26	V <sub>SS</sub>	
N27	V <sub>DD</sub> PEHA		P27	V <sub>SS</sub>		R27	V <sub>DD</sub> PETA		T27	V <sub>SS</sub>	
N28	NC		P28	V <sub>SS</sub>		R28	V <sub>SS</sub>		T28	V <sub>SS</sub>	
N29	V <sub>SS</sub>		P29	V <sub>SS</sub>		R29	REFRES00		T29	NC	
N30	PE00RP2		P30	V <sub>SS</sub>		R30	PE00RP1		T30	PE00RP0	
N31	PE00RN2		P31	V <sub>SS</sub>		R31	PE00RN1		T31	PE00RN0	
N32	V <sub>SS</sub>		P32	V <sub>SS</sub>		R32	V <sub>SS</sub>		T32	V <sub>SS</sub>	
N33	PE00TN2		P33	V <sub>SS</sub>		R33	PE00TN1		T33	PE00TN0	
N34	PE00TP2		P34	V <sub>SS</sub>		R34	PE00TP1		T34	PE00TP0	

Table 23 PES34H16G2 Signal Pin-Out (Part 4 of 9)

Pin	Function	Alt	Pin	Function	Alt	Pin	Function	Alt	Pin	Function	Alt
U1	NC		V1	V <sub>SS</sub>		W1	PE04TP0		Y1	PE04TP1	
U2	NC		V2	V <sub>SS</sub>		W2	PE04TN0		Y2	PE04TN1	
U3	V <sub>SS</sub>		V3	V <sub>SS</sub>		W3	V <sub>SS</sub>		Y3	V <sub>SS</sub>	
U4	NC		V4	V <sub>SS</sub>		W4	PE04RN0		Y4	PE04RN1	
U5	NC		V5	V <sub>SS</sub>		W5	PE04RP0		Y5	PE04RP1	
U6	V <sub>SS</sub>		V6	V <sub>SS</sub>		W6	V <sub>SS</sub>		Y6	NC	
U7	NC		V7	NC		W7	V <sub>SS</sub>		Y7	REFRES04	
U8	V <sub>SS</sub>		V8	V <sub>SS</sub>		W8	V <sub>SS</sub>		Y8	V <sub>DD</sub> PETA	
U9	V <sub>DD</sub> PEHA		V9	V <sub>DD</sub> PEHA		W9	V <sub>SS</sub>		Y9	V <sub>SS</sub>	
U10	V <sub>DD</sub> PEHA		V10	V <sub>DD</sub> PEHA		W10	V <sub>SS</sub>		Y10	V <sub>DD</sub> PETA	
U11	V <sub>DD</sub> PEA		V11	V <sub>DD</sub> PEA		W11	V <sub>SS</sub>		Y11	V <sub>DD</sub> PEA	
U12	V <sub>DD</sub> PEA		V12	V <sub>DD</sub> PEA		W12	V <sub>SS</sub>		Y12	V <sub>DD</sub> PEA	
U13	V <sub>DD</sub> CORE		V13	V <sub>SS</sub>		W13	V <sub>DD</sub> CORE		Y13	V <sub>DD</sub> CORE	
U14	V <sub>DD</sub> CORE		V14	V <sub>SS</sub>		W14	V <sub>DD</sub> CORE		Y14	V <sub>SS</sub>	
U15	V <sub>SS</sub>		V15	V <sub>DD</sub> CORE		W15	V <sub>SS</sub>		Y15	V <sub>DD</sub> CORE	
U16	V <sub>DD</sub> CORE		V16	V <sub>SS</sub>		W16	V <sub>DD</sub> CORE		Y16	V <sub>SS</sub>	
U17	V <sub>SS</sub>		V17	V <sub>DD</sub> CORE		W17	V <sub>SS</sub>		Y17	V <sub>DD</sub> CORE	
U18	V <sub>DD</sub> CORE		V18	V <sub>SS</sub>		W18	V <sub>DD</sub> CORE		Y18	V <sub>SS</sub>	
U19	V <sub>SS</sub>		V19	V <sub>DD</sub> CORE		W19	V <sub>SS</sub>		Y19	V <sub>DD</sub> CORE	
U20	V <sub>DD</sub> CORE		V20	V <sub>SS</sub>		W20	V <sub>DD</sub> CORE		Y20	V <sub>SS</sub>	
U21	V <sub>SS</sub>		V21	V <sub>DD</sub> CORE		W21	V <sub>SS</sub>		Y21	V <sub>DD</sub> CORE	
U22	V <sub>SS</sub>		V22	V <sub>DD</sub> CORE		W22	V <sub>SS</sub>		Y22	V <sub>DD</sub> CORE	
U23	V <sub>DD</sub> PEA		V23	V <sub>DD</sub> PEA		W23	V <sub>SS</sub>		Y23	V <sub>DD</sub> PEA	
U24	V <sub>DD</sub> PEA		V24	V <sub>DD</sub> PEA		W24	V <sub>SS</sub>		Y24	V <sub>DD</sub> PEA	
U25	V <sub>DD</sub> PEHA		V25	V <sub>DD</sub> PEHA		W25	V <sub>SS</sub>		Y25	V <sub>DD</sub> PETA	
U26	V <sub>DD</sub> PEHA		V26	V <sub>DD</sub> PEHA		W26	NC		Y26	V <sub>SS</sub>	
U27	V <sub>SS</sub>		V27	V <sub>SS</sub>		W27	V <sub>SS</sub>		Y27	V <sub>DD</sub> PETA	
U28	NC		V28	NC		W28	V <sub>SS</sub>		Y28	V <sub>SS</sub>	
U29	V <sub>SS</sub>		V29	V <sub>SS</sub>		W29	REFRES15		Y29	NC	
U30	V <sub>SS</sub>		V30	NC		W30	NC		Y30	V <sub>SS</sub>	
U31	V <sub>SS</sub>		V31	NC		W31	NC		Y31	V <sub>SS</sub>	
U32	V <sub>SS</sub>		V32	V <sub>SS</sub>		W32	V <sub>SS</sub>		Y32	V <sub>SS</sub>	
U33	V <sub>SS</sub>		V33	NC		W33	NC		Y33	V <sub>SS</sub>	
U34	V <sub>SS</sub>		V34	NC		W34	NC		Y34	V <sub>SS</sub>	

Table 23 PES34H16G2 Signal Pin-Out (Part 5 of 9)

Pin	Function	Alt	Pin	Function	Alt	Pin	Function	Alt	Pin	Function	Alt
AA1	V <sub>SS</sub>		AB1	PE04TP2		AC1	PE04TP3		AD1	V <sub>SS</sub>	
AA2	V <sub>SS</sub>		AB2	PE04TN2		AC2	PE04TN3		AD2	V <sub>SS</sub>	
AA3	V <sub>SS</sub>		AB3	V <sub>SS</sub>		AC3	V <sub>SS</sub>		AD3	V <sub>SS</sub>	
AA4	V <sub>SS</sub>		AB4	PE04RN2		AC4	PE04RN3		AD4	V <sub>SS</sub>	
AA5	V <sub>SS</sub>		AB5	PE04RP2		AC5	PE04RP3		AD5	V <sub>SS</sub>	
AA6	V <sub>SS</sub>		AB6	REFRES05		AC6	V <sub>SS</sub>		AD6	V <sub>SS</sub>	
AA7	V <sub>SS</sub>		AB7	NC		AC7	V <sub>SS</sub>		AD7	V <sub>SS</sub>	
AA8	V <sub>SS</sub>		AB8	V <sub>DD</sub> PEHA		AC8	V <sub>SS</sub>		AD8	V <sub>SS</sub>	
AA9	V <sub>DD</sub> PEA		AB9	V <sub>SS</sub>		AC9	V <sub>SS</sub>		AD9	NC	
AA10	V <sub>SS</sub>		AB10	V <sub>DD</sub> PEHA		AC10	V <sub>SS</sub>		AD10	NC	
AA11	V <sub>DD</sub> PEA		AB11	V <sub>DD</sub> PEA		AC11	V <sub>SS</sub>		AD11	V <sub>SS</sub>	
AA12	V <sub>SS</sub>		AB12	V <sub>DD</sub> PEA		AC12	V <sub>SS</sub>		AD12	V <sub>SS</sub>	
AA13	V <sub>DD</sub> CORE		AB13	V <sub>DD</sub> CORE		AC13	V <sub>DD</sub> PEA		AD13	V <sub>DD</sub> PEA	
AA14	V <sub>DD</sub> CORE		AB14	V <sub>DD</sub> CORE		AC14	V <sub>SS</sub>		AD14	V <sub>DD</sub> PEA	
AA15	V <sub>SS</sub>		AB15	V <sub>DD</sub> CORE		AC15	V <sub>DD</sub> PEA		AD15	V <sub>DD</sub> PEA	
AA16	V <sub>DD</sub> CORE		AB16	V <sub>DD</sub> CORE		AC16	V <sub>SS</sub>		AD16	V <sub>SS</sub>	
AA17	V <sub>SS</sub>		AB17	V <sub>SS</sub>		AC17	V <sub>DD</sub> PEA		AD17	V <sub>DD</sub> PEA	
AA18	V <sub>DD</sub> CORE		AB18	V <sub>DD</sub> CORE		AC18	V <sub>DD</sub> PEA		AD18	V <sub>DD</sub> PEA	
AA19	V <sub>SS</sub>		AB19	V <sub>SS</sub>		AC19	V <sub>SS</sub>		AD19	V <sub>SS</sub>	
AA20	V <sub>DD</sub> CORE		AB20	V <sub>DD</sub> CORE		AC20	V <sub>DD</sub> PEA		AD20	V <sub>DD</sub> PEA	
AA21	V <sub>SS</sub>		AB21	V <sub>DD</sub> CORE		AC21	V <sub>SS</sub>		AD21	V <sub>DD</sub> PEA	
AA22	V <sub>DD</sub> CORE		AB22	V <sub>DD</sub> CORE		AC22	V <sub>DD</sub> PEA		AD22	V <sub>DD</sub> PEA	
AA23	V <sub>SS</sub>		AB23	V <sub>DD</sub> PEA		AC23	V <sub>SS</sub>		AD23	V <sub>SS</sub>	
AA24	V <sub>DD</sub> PEA		AB24	V <sub>DD</sub> PEA		AC24	V <sub>SS</sub>		AD24	V <sub>SS</sub>	
AA25	V <sub>SS</sub>		AB25	V <sub>DD</sub> PEHA		AC25	V <sub>SS</sub>		AD25	V <sub>SS</sub>	
AA26	V <sub>DD</sub> PEA		AB26	V <sub>SS</sub>		AC26	V <sub>SS</sub>		AD26	V <sub>SS</sub>	
AA27	V <sub>SS</sub>		AB27	V <sub>DD</sub> PEHA		AC27	V <sub>SS</sub>		AD27	V <sub>SS</sub>	
AA28	V <sub>SS</sub>		AB28	V <sub>SS</sub>		AC28	V <sub>SS</sub>		AD28	V <sub>SS</sub>	
AA29	REFRES14		AB29	V <sub>SS</sub>		AC29	V <sub>SS</sub>		AD29	V <sub>SS</sub>	
AA30	NC		AB30	PE15RP0		AC30	V <sub>SS</sub>		AD30	NC	
AA31	NC		AB31	PE15RN0		AC31	V <sub>SS</sub>		AD31	NC	
AA32	V <sub>SS</sub>		AB32	V <sub>SS</sub>		AC32	V <sub>SS</sub>		AD32	V <sub>SS</sub>	
AA33	NC		AB33	PE15TN0		AC33	V <sub>SS</sub>		AD33	NC	
AA34	NC		AB34	PE15TP0		AC34	V <sub>SS</sub>		AD34	NC	

Table 23 PES34H16G2 Signal Pin-Out (Part 6 of 9)

Pin	Function	Alt	Pin	Function	Alt	Pin	Function	Alt	Pin	Function	Alt
AE1	PE05TP0		AF1	PE05TP1		AG1	V <sub>SS</sub>		AH1	PE05TP2	
AE2	PE05TN0		AF2	PE05TN1		AG2	V <sub>SS</sub>		AH2	PE05TN2	
AE3	V <sub>SS</sub>		AF3	V <sub>SS</sub>		AG3	V <sub>SS</sub>		AH3	V <sub>SS</sub>	
AE4	PE05RN0		AF4	PE05RN1		AG4	V <sub>SS</sub>		AH4	PE05RN2	
AE5	PE05RP0		AF5	PE05RP1		AG5	V <sub>SS</sub>		AH5	PE05RP2	
AE6	V <sub>SS</sub>		AF6	V <sub>SS</sub>		AG6	V <sub>SS</sub>		AH6	V <sub>SS</sub>	
AE7	V <sub>SS</sub>		AF7	V <sub>SS</sub>		AG7	CLKMODE0		AH7	V <sub>SS</sub>	
AE8	V <sub>SS</sub>		AF8	V <sub>SS</sub>		AG8	V <sub>DD</sub> I/O		AH8	GCLKFSEL	
AE9	V <sub>DD</sub> I/O		AF9	V <sub>DD</sub> I/O		AG9	V <sub>SS</sub>		AH9	V <sub>SS</sub>	
AE10	V <sub>SS</sub>		AF10	V <sub>DD</sub> I/O		AG10	V <sub>SS</sub>		AH10	V <sub>SS</sub>	
AE11	V <sub>SS</sub>		AF11	V <sub>SS</sub>		AG11	V <sub>SS</sub>		AH11	V <sub>SS</sub>	
AE12	V <sub>SS</sub>		AF12	V <sub>SS</sub>		AG12	V <sub>SS</sub>		AH12	V <sub>SS</sub>	
AE13	V <sub>DD</sub> PEHA		AF13	V <sub>SS</sub>		AG13	V <sub>DD</sub> PEHA		AH13	V <sub>SS</sub>	
AE14	V <sub>SS</sub>		AF14	V <sub>DD</sub> PEA		AG14	V <sub>SS</sub>		AH14	REFRES06	
AE15	V <sub>DD</sub> PETA		AF15	V <sub>SS</sub>		AG15	V <sub>DD</sub> PETA		AH15	V <sub>SS</sub>	
AE16	V <sub>SS</sub>		AF16	V <sub>SS</sub>		AG16	V <sub>SS</sub>		AH16	NC	
AE17	V <sub>DD</sub> PEHA		AF17	V <sub>DD</sub> PEHA		AG17	V <sub>SS</sub>		AH17	GCLKP1	
AE18	V <sub>DD</sub> PEHA		AF18	V <sub>DD</sub> PEHA		AG18	V <sub>SS</sub>		AH18	GCLKN1	
AE19	V <sub>SS</sub>		AF19	V <sub>SS</sub>		AG19	V <sub>SS</sub>		AH19	V <sub>SS</sub>	
AE20	V <sub>DD</sub> PETA		AF20	V <sub>SS</sub>		AG20	V <sub>DD</sub> PETA		AH20	REFRES12	
AE21	V <sub>SS</sub>		AF21	V <sub>DD</sub> PEA		AG21	NC		AH21	V <sub>SS</sub>	
AE22	V <sub>DD</sub> PEHA		AF22	V <sub>SS</sub>		AG22	V <sub>DD</sub> PEHA		AH22	NC	
AE23	V <sub>SS</sub>		AF23	V <sub>SS</sub>		AG23	V <sub>SS</sub>		AH23	REFRES13	
AE24	V <sub>SS</sub>		AF24	V <sub>SS</sub>		AG24	V <sub>SS</sub>		AH24	V <sub>SS</sub>	
AE25	GPIO_06		AF25	V <sub>SS</sub>		AG25	V <sub>SS</sub>		AH25	V <sub>SS</sub>	
AE26	V <sub>DD</sub> I/O		AF26	GPIO_09	1	AG26	V <sub>DD</sub> I/O		AH26	V <sub>SS</sub>	
AE27	V <sub>SS</sub>		AF27	V <sub>SS</sub>		AG27	GPIO_04	1	AH27	V <sub>SS</sub>	
AE28	V <sub>SS</sub>		AF28	V <sub>SS</sub>		AG28	V <sub>SS</sub>		AH28	V <sub>SS</sub>	
AE29	V <sub>SS</sub>		AF29	V <sub>SS</sub>		AG29	V <sub>SS</sub>		AH29	V <sub>SS</sub>	
AE30	NC		AF30	V <sub>SS</sub>		AG30	NC		AH30	PE14RP0	
AE31	NC		AF31	V <sub>SS</sub>		AG31	NC		AH31	PE14RN0	
AE32	V <sub>SS</sub>		AF32	V <sub>SS</sub>		AG32	V <sub>SS</sub>		AH32	V <sub>SS</sub>	
AE33	NC		AF33	V <sub>SS</sub>		AG33	NC		AH33	PE14TN0	
AE34	NC		AF34	V <sub>SS</sub>		AG34	NC		AH34	PE14TP0	

Table 23 PES34H16G2 Signal Pin-Out (Part 7 of 9)

Pin	Function	Alt	Pin	Function	Alt	Pin	Function	Alt	Pin	Function	Alt
AJ1	PE05TP3		AK1	V <sub>SS</sub>		AL1	V <sub>DD</sub> I/O		AM1	P23MERGEN	
AJ2	PE05TN3		AK2	V <sub>SS</sub>		AL2	P01MERGEN		AM2	V <sub>DD</sub> I/O	
AJ3	V <sub>SS</sub>		AK3	V <sub>SS</sub>		AL3	P45MERGEN		AM3	V <sub>DD</sub> I/O	
AJ4	PE05RN3		AK4	V <sub>SS</sub>		AL4	V <sub>DD</sub> I/O		AM4	V <sub>DD</sub> I/O	
AJ5	PE05RP3		AK5	V <sub>SS</sub>		AL5	V <sub>DD</sub> I/O		AM5	SWMODE3	
AJ6	V <sub>SS</sub>		AK6	V <sub>SS</sub>		AL6	V <sub>SS</sub>		AM6	V <sub>SS</sub>	
AJ7	V <sub>SS</sub>		AK7	PE06RP0		AL7	PE06RN0		AM7	V <sub>SS</sub>	
AJ8	V <sub>SS</sub>		AK8	NC		AL8	NC		AM8	V <sub>SS</sub>	
AJ9	V <sub>SS</sub>		AK9	V <sub>SS</sub>		AL9	V <sub>SS</sub>		AM9	V <sub>SS</sub>	
AJ10	V <sub>SS</sub>		AK10	NC		AL10	NC		AM10	V <sub>SS</sub>	
AJ11	V <sub>SS</sub>		AK11	NC		AL11	NC		AM11	V <sub>SS</sub>	
AJ12	V <sub>SS</sub>		AK12	V <sub>SS</sub>		AL12	V <sub>SS</sub>		AM12	V <sub>SS</sub>	
AJ13	V <sub>SS</sub>		AK13	PE07RP0		AL13	PE07RN0		AM13	V <sub>SS</sub>	
AJ14	NC		AK14	NC		AL14	NC		AM14	V <sub>SS</sub>	
AJ15	V <sub>SS</sub>		AK15	V <sub>SS</sub>		AL15	V <sub>SS</sub>		AM15	V <sub>SS</sub>	
AJ16	REFRES07		AK16	NC		AL16	NC		AM16	V <sub>SS</sub>	
AJ17	V <sub>SS</sub>		AK17	NC		AL17	NC		AM17	V <sub>SS</sub>	
AJ18	V <sub>SS</sub>		AK18	V <sub>SS</sub>		AL18	V <sub>SS</sub>		AM18	V <sub>SS</sub>	
AJ19	V <sub>SS</sub>		AK19	PE12RP0		AL19	PE12RN0		AM19	V <sub>SS</sub>	
AJ20	V <sub>SS</sub>		AK20	NC		AL20	NC		AM20	V <sub>SS</sub>	
AJ21	V <sub>SS</sub>		AK21	V <sub>SS</sub>		AL21	V <sub>SS</sub>		AM21	V <sub>SS</sub>	
AJ22	V <sub>SS</sub>		AK22	NC		AL22	NC		AM22	V <sub>SS</sub>	
AJ23	V <sub>SS</sub>		AK23	NC		AL23	NC		AM23	V <sub>SS</sub>	
AJ24	V <sub>SS</sub>		AK24	V <sub>SS</sub>		AL24	V <sub>SS</sub>		AM24	V <sub>SS</sub>	
AJ25	V <sub>SS</sub>		AK25	PE13RP0		AL25	PE13RN0		AM25	V <sub>SS</sub>	
AJ26	V <sub>SS</sub>		AK26	NC		AL26	NC		AM26	V <sub>SS</sub>	
AJ27	V <sub>SS</sub>		AK27	V <sub>SS</sub>		AL27	V <sub>SS</sub>		AM27	V <sub>SS</sub>	
AJ28	V <sub>SS</sub>		AK28	NC		AL28	NC		AM28	V <sub>SS</sub>	
AJ29	V <sub>SS</sub>		AK29	NC		AL29	NC		AM29	V <sub>SS</sub>	
AJ30	V <sub>SS</sub>		AK30	V <sub>SS</sub>		AL30	V <sub>SS</sub>		AM30	V <sub>SS</sub>	
AJ31	V <sub>SS</sub>		AK31	GPIO_08	1	AL31	GPIO_07		AM31	GPIO_00	1
AJ32	V <sub>SS</sub>		AK32	GPIO_15	1	AL32	V <sub>DD</sub> I/O		AM32	GPIO_05	2
AJ33	V <sub>SS</sub>		AK33	GPIO_14	1	AL33	GPIO_10	1	AM33	GPIO_11	1
AJ34	V <sub>SS</sub>		AK34	V <sub>DD</sub> I/O		AL34	GPIO_12	1	AM34	GPIO_13	1

Table 23 PES34H16G2 Signal Pin-Out (Part 8 of 9)

Pin	Function	Alt	Pin	Function	Alt	Pin	Function	Alt	Pin	Function	Alt
AN1	V <sub>SS</sub>		AN18	V <sub>SS</sub>		AP1	V <sub>SS</sub>		AP18	V <sub>SS</sub>	
AN2	V <sub>DD</sub> /I/O		AN19	PE12TN0		AP2	V <sub>SS</sub>		AP19	PE12TP0	
AN3	V <sub>DD</sub> /I/O		AN20	NC		AP3	RSTHALT		AP20	NC	
AN4	SWMODE0		AN21	V <sub>SS</sub>		AP4	SWMODE1		AP21	V <sub>SS</sub>	
AN5	SWMODE2		AN22	NC		AP5	V <sub>DD</sub> /I/O		AP22	NC	
AN6	V <sub>SS</sub>		AN23	NC		AP6	V <sub>SS</sub>		AP23	NC	
AN7	PE06TN0		AN24	V <sub>SS</sub>		AP7	PE06TP0		AP24	V <sub>SS</sub>	
AN8	NC		AN25	PE13TN0		AP8	NC		AP25	PE13TP0	
AN9	V <sub>SS</sub>		AN26	NC		AP9	V <sub>SS</sub>		AP26	NC	
AN10	NC		AN27	V <sub>SS</sub>		AP10	NC		AP27	V <sub>SS</sub>	
AN11	NC		AN28	NC		AP11	NC		AP28	NC	
AN12	V <sub>SS</sub>		AN29	NC		AP12	V <sub>SS</sub>		AP29	NC	
AN13	PE07TN0		AN30	V <sub>SS</sub>		AP13	PE07TP0		AP30	V <sub>SS</sub>	
AN14	NC		AN31	GPIO_01	1	AP14	NC		AP31	V <sub>DD</sub> /I/O	
AN15	V <sub>SS</sub>		AN32	GPIO_02	1	AP15	V <sub>SS</sub>		AP32	GPIO_03	1
AN16	NC		AN33	V <sub>DD</sub> /I/O		AP16	NC		AP33	V <sub>SS</sub>	
AN17	NC		AN34	V <sub>SS</sub>		AP17	NC		AP34	V <sub>SS</sub>	

Table 23 PES34H16G2 Signal Pin-Out (Part 9 of 9)

Alternate Signal Functions

Pin	GPIO	1st Alternate	2nd Alternate	Pin	GPIO	1st Alternate	2nd Alternate
AM31	GPIO_00	PART0PERSTN	—	B4	GPIO_17	HP0RSTN	—
AN31	GPIO_01	PART1PERSTN	—	B3	GPIO_18	HP1APN	—
AN32	GPIO_02	PART2PERSTN	—	A3	GPIO_19	HP1PDN	—
AP32	GPIO_03	PART3PERSTN	—	H8	GPIO_20	HP1PFN	—
AG27	GPIO_04	—	POLINKUPN	C3	GPIO_21	HP1PWRGDN	—
AM32	GPIO_05	GPEN	P0ACTIVEN	K10	GPIO_22	HP1MRLN	P1LINKUPN
AK31	GPIO_08	IOEXPINTN	—	D4	GPIO_23	HP1AIN	P1ACTIVEN
AF26	GPIO_09	HP0APN	—	E4	GPIO_24	HP1PIN	P2LINKUPN
AL33	GPIO_10	HP0PDN	—	J9	GPIO_25	HP1PEP	P2ACTIVEN
AM33	GPIO_11	HP0PFN	—	D2	GPIO_26	HP1RSTN	P3LINKUPN
AL34	GPIO_12	HP0PWRGDN	—	C2	GPIO_27	HP2APN	P3ACTIVEN
AM34	GPIO_13	HP0MRLN	—	D1	GPIO_28	HP2PDN	P4LINKUPN
AK33	GPIO_14	HP0AIN	—	C1	GPIO_29	HP2PFN	P4ACTIVEN
AK32	GPIO_15	HP0PIN	—	E2	GPIO_30	HP2PWRGDN	P5LINKUPN
C4	GPIO_16	HP0PEP	—	E3	GPIO_31	HP2MRLN	P5ACTIVEN

Table 24 PES34H16G2 Alternate Signal Functions

Power Pins

V <sub>DD</sub> Core	V <sub>DD</sub> Core	V <sub>DD</sub> I/O	V <sub>DD</sub> PEA	V <sub>DD</sub> PEA	V <sub>DD</sub> PEHA	V <sub>DD</sub> PETA
N13	V15	A4	J14	V11	H13	H15
N14	V17	A30	J21	V12	H22	H20
N15	V19	B2	L13	V23	J17	K15
N17	V21	B33	L14	V24	J18	K20
N19	V22	D3	L15	Y11	K13	R8
N20	W13	D31	L17	Y12	K17	R10
N21	W14	D34	L18	Y23	K18	R25
N22	W16	E1	L20	Y24	K22	R27
P13	W18	H9	L21	AA9	N8	Y8
P15	W20	H27	L22	AA11	N10	Y10
P17	Y13	J26	M13	AA24	N25	Y25
P19	Y15	K9	M15	AA26	N27	Y27
P21	Y17	AE9	M17	AB11	U9	AE15
P22	Y19	AE26	M18	AB12	U10	AE20
R13	Y21	AF9	M20	AB23	U25	AG15
R14	Y22	AF10	M22	AB24	U26	AG20
R16	AA13	AG8	N11	AC13	V9	
R18	AA14	AG26	N12	AC15	V10	
R20	AA16	AK34	N23	AC17	V25	
R22	AA18	AL1	N24	AC18	V26	
T15	AA20	AL4	P9	AC20	AB8	
T17	AA22	AL5	P11	AC22	AB10	
T19	AB13	AL32	P24	AD13	AB25	
T21	AB14	AM2	P26	AD14	AB27	
T22	AB15	AM3	R11	AD15	AE13	
U13	AB16	AM4	R12	AD17	AE17	
U14	AB18	AN2	R23	AD18	AE18	
U16	AB20	AN3	R24	AD20	AE22	
U18	AB21	AN33	U11	AD21	AF17	
U20	AB22	AP5	U12	AD22	AF18	
		AP31	U23	AF14	AG13	
			U24	AF21	AG22	

Table 25 PES34H16G2 Power Pins

## Ground Pins

V <sub>SS</sub>	V <sub>SS</sub>	V <sub>SS</sub>	V <sub>SS</sub>	V <sub>SS</sub>	V <sub>SS</sub>	V <sub>SS</sub>	V <sub>SS</sub>
A1	C16	E33	G11	J3	L3	M16	P32
A2	C17	E34	G13	J4	L6	M19	P33
A5	C18	F1	G14	J5	L7	M21	P34
A8	C19	F2	G16	J6	L8	M23	R1
A11	C20	F3	G20	J7	L9	M24	R2
A14	C21	F4	G21	J8	L10	M25	R3
A17	C22	F5	G23	J10	L11	M26	R4
A20	C23	F6	G24	J11	L12	M27	R5
A23	C24	F7	G25	J12	L16	M29	R6
A26	C25	F8	G26	J13	L19	M32	R9
A29	C26	F9	G28	J16	L23	N3	R15
A33	C27	F11	G29	J19	L24	N6	R17
A34	C28	F12	G32	J20	L25	N9	R19
B1	C29	F13	H3	J22	L26	N16	R21
B5	D5	F14	H6	J23	L27	N18	R26
B8	D8	F15	H7	J24	L28	N26	R28
B11	D11	F16	H10	J28	L29	N29	R32
B14	D14	F18	H11	J29	L30	N32	T3
B17	D17	F20	H12	J32	L31	P3	T7
B20	D20	F21	H14	K3	L32	P6	T8
B23	D23	F22	H16	K6	L33	P7	T10
B26	D26	F23	H17	K7	L34	P8	T11
B29	D29	F24	H18	K8	M1	P10	T12
B34	E5	F25	H19	K11	M2	P12	T13
C5	E8	F26	H23	K12	M3	P14	T14
C6	E11	F27	H24	K14	M4	P16	T16
C7	E14	F28	H25	K16	M5	P18	T18
C8	E17	F29	H29	K19	M6	P20	T20
C9	E20	F32	H30	K21	M7	P23	T23
C10	E23	G3	H31	K23	M8	P25	T24
C11	E26	G6	H32	K24	M9	P27	T25
C12	E29	G7	H33	K27	M10	P28	T26
C13	E30	G8	H34	K28	M11	P29	T27
C14	E31	G9	J1	K29	M12	P30	T28
C15	E32	G10	J2	K32	M14	P31	T32

Table 26 PES34H16G2 Ground Pins (Part 1 of 3)



V <sub>SS</sub>	V <sub>SS</sub>	V <sub>SS</sub>	V <sub>SS</sub>	V <sub>SS</sub>	V <sub>SS</sub>	V <sub>SS</sub>	V <sub>SS</sub>
U3	W12	AA19	AC33	AE29	AG17	AJ17	AL21
U6	W15	AA21	AC34	AE32	AG18	AJ18	AL24
U8	W17	AA23	AD1	AF3	AG19	AJ19	AL27
U15	W19	AA25	AD2	AF6	AG23	AJ20	AL30
U17	W21	AA27	AD3	AF7	AG24	AJ21	AM6
U19	W22	AA28	AD4	AF8	AG25	AJ22	AM7
U21	W23	AA32	AD5	AF11	AG28	AJ23	AM8
U22	W24	AB3	AD6	AF12	AG29	AJ24	AM9
U27	W25	AB9	AD7	AF13	AG32	AJ25	AM10
U29	W27	AB17	AD8	AF15	AH3	AJ26	AM11
U30	W28	AB19	AD11	AF16	AH6	AJ27	AM12
U31	W32	AB26	AD12	AF19	AH7	AJ28	AM13
U32	Y3	AB28	AD16	AF20	AH9	AJ29	AM14
U33	Y9	AB29	AD19	AF22	AH10	AJ30	AM15
U34	Y14	AB32	AD23	AF23	AH11	AJ31	AM16
V1	Y16	AC3	AD24	AF24	AH12	AJ32	AM17
V2	Y18	AC6	AD25	AF25	AH13	AJ33	AM18
V3	Y20	AC7	AD26	AF27	AH15	AJ34	AM19
V4	Y26	AC8	AD27	AF28	AH19	AK1	AM20
V5	Y28	AC9	AD28	AF29	AH21	AK2	AM21
V6	Y30	AC10	AD29	AF30	AH24	AK3	AM22
V8	Y31	AC11	AD32	AF31	AH25	AK4	AM23
V13	Y32	AC12	AE3	AF32	AH26	AK5	AM24
V14	Y33	AC14	AE6	AF33	AH27	AK6	AM25
V16	Y34	AC16	AE7	AF34	AH28	AK9	AM26
V18	AA1	AC19	AE8	AG1	AH29	AK12	AM27
V20	AA2	AC21	AE10	AG2	AH32	AK15	AM28
V27	AA3	AC23	AE11	AG3	AJ3	AK18	AM29
V29	AA4	AC24	AE12	AG4	AJ6	AK21	AM30
V32	AA5	AC25	AE14	AG5	AJ7	AK24	AN1
W3	AA6	AC26	AE16	AG6	AJ8	AK27	AN6
W6	AA7	AC27	AE19	AG9	AJ9	AK30	AN9
W7	AA8	AC28	AE21	AG10	AJ10	AL6	AN12
W8	AA10	AC29	AE23	AG11	AJ11	AL9	AN15
W9	AA12	AC30	AE24	AG12	AJ12	AL12	AN18
W10	AA15	AC31	AE27	AG14	AJ13	AL15	AN21
W11	AA17	AC32	AE28	AG16	AJ15	AL18	AN24

Table 26 PES34H16G2 Ground Pins (Part 2 of 3)

V <sub>SS</sub>	V <sub>SS</sub>	V <sub>SS</sub>	V <sub>SS</sub>	V <sub>SS</sub>	V <sub>SS</sub>	V <sub>SS</sub>	V <sub>SS</sub>
AN27	AN34	AP2	AP9	AP15	AP21	AP27	AP33
AN30	AP1	AP6	AP12	AP18	AP24	AP30	AP34

Table 26 PES34H16G2 Ground Pins (Part 3 of 3)

No Connection Pins

NC	NC	NC	NC	NC	NC
A6	G12	T4	AA31	AK11	AN11
A7	G15	T5	AA33	AK14	AN14
A9	G19	T6	AA34	AK16	AN16
A12	G22	T29	AB7	AK17	AN17
A13	H1	U1	AD9	AK20	AN20
A15	H2	U2	AD10	AK22	AN22
B6	H4	U4	AD30	AK23	AN23
B7	H5	U5	AD31	AK26	AN26
B9	K1	U7	AD33	AK28	AN28
B12	K2	U28	AD34	AK29	AN29
B13	K4	V7	AE30	AL8	AP8
B15	K5	V28	AE31	AL10	AP10
D6	L1	V30	AE33	AL11	AP11
D7	L2	V31	AE34	AL14	AP14
D9	L4	V33	AG21	AL16	AP16
D12	L5	V34	AG30	AL17	AP17
D13	N7	W26	AG31	AL20	AP20
D15	N28	W30	AG33	AL22	AP22
E6	P1	W31	AG34	AL23	AP23
E7	P2	W33	AH16	AL26	AP26
E9	P4	W34	AH22	AL28	AP28
E12	P5	Y6	AJ14	AL29	AP29
E13	T1	Y29	AK8	AN8	
E15	T2	AA30	AK10	AN10	

Table 27 PES34H16G2 No Connection Pins

## Signals Listed Alphabetically

Signal Name	I/O Type	Location	Signal Category
CLKMODE0	I	AG7	System
CLKMODE1	I	K25	
GCLKFSEL	I	AH8	
GCLKN0	I	G17	
GCLKN1	I	AH18	
GCLKP0	I	G18	
GCLKP1	I	AH17	
GPIO_00	I/O	AM31	General Purpose I/O
GPIO_01	I/O	AN31	
GPIO_02	I/O	AN32	
GPIO_03	I/O	AP32	
GPIO_04	I/O	AG27	
GPIO_05	I/O	AM32	
GPIO_06	I/O	AE25	
GPIO_07	I/O	AL31	
GPIO_08	I/O	AK31	
GPIO_09	I/O	AF26	
GPIO_10	I/O	AL33	
GPIO_11	I/O	AM33	
GPIO_12	I/O	AL34	
GPIO_13	I/O	AM34	
GPIO_14	I/O	AK33	
GPIO_15	I/O	AK32	
GPIO_16	I/O	C4	
GPIO_17	I/O	B4	
GPIO_18	I/O	B3	
GPIO_19	I/O	A3	
GPIO_20	I/O	H8	
GPIO_21	I/O	C3	
GPIO_22	I/O	K10	
GPIO_23	I/O	D4	
GPIO_24	I/O	E4	
GPIO_25	I/O	J9	
GPIO_26	I/O	D2	

Table 28 PES34H16G2 Alphabetical Signal List (Part 1 of 7)

Signal Name	I/O Type	Location	Signal Category
GPIO_27	I/O	C2	General Purpose I/O (Cont.)
GPIO_28	I/O	D1	
GPIO_29	I/O	C1	
GPIO_30	I/O	E2	
GPIO_31	I/O	E3	
JTAG_TCK	I	K26	Test
JTAG_TDI	I	C31	
JTAG_TDO	O	J25	
JTAG_TMS	I	D30	
JTAG_TRST_N	I	C32	
MSMBADDR1	I	A31	SMBus Interface
MSMBADDR2	I	B31	
MSMBADDR3	I	B30	
MSMBADDR4	I	C30	
MSMBCLK	I/O	G27	
MSMBDAT	I/O	H26	
MSMBSMODE	I	A32	System
NO CONNECTION	See Table 27 for a listing of No Connect pins.		
P01MERGEN	I	AL2	System
P23MERGEN	I	AM1	
P45MERGEN	I	AL3	
PE00RN0	I	T31	PCI Express
PE00RN1	I	R31	
PE00RN2	I	N31	
PE00RN3	I	M31	
PE00RP0	I	T30	
PE00RP1	I	R30	
PE00RP2	I	N30	
PE00RP3	I	M30	
PE00TN0	O	T33	
PE00TN1	O	R33	
PE00TN2	O	N33	
PE00TN3	O	M33	
PE00TP0	O	T34	
PE00TP1	O	R34	
PE00TP2	O	N34	

Table 28 PES34H16G2 Alphabetical Signal List (Part 2 of 7)

Signal Name	I/O Type	Location	Signal Category
PE00TP3	O	M34	PCI Express (cont.)
PE01RN0	I	K31	
PE01RN1	I	J31	
PE01RN2	I	G31	
PE01RN3	I	F31	
PE01RP0	I	K30	
PE01RP1	I	J30	
PE01RP2	I	G30	
PE01RP3	I	F30	
PE01TN0	O	K33	
PE01TN1	O	J33	
PE01TN2	O	G33	
PE01TN3	O	F33	
PE01TP0	O	K34	
PE01TP1	O	J34	
PE01TP2	O	G34	
PE01TP3	O	F34	
PE02RN0	I	D28	
PE02RN1	I	D27	
PE02RN2	I	D25	
PE02RN3	I	D24	
PE02RP0	I	E28	
PE02RP1	I	E27	
PE02RP2	I	E25	
PE02RP3	I	E24	
PE02TN0	O	B28	
PE02TN1	O	B27	
PE02TN2	O	B25	
PE02TN3	O	B24	
PE02TP0	O	A28	
PE02TP1	O	A27	
PE02TP2	O	A25	
PE02TP3	O	A24	
PE03RN0	I	D22	
PE03RN1	I	D21	
PE03RN2	I	D19	

Table 28 PES34H16G2 Alphabetical Signal List (Part 3 of 7)

Signal Name	I/O Type	Location	Signal Category
PE03RN3	I	D18	PCI Express (cont.)
PE03RP0	I	E22	
PE03RP1	I	E21	
PE03RP2	I	E19	
PE03RP3	I	E18	
PE03TN0	O	B22	
PE03TN1	O	B21	
PE03TN2	O	B19	
PE03TN3	O	B18	
PE03TP0	O	A22	
PE03TP1	O	A21	
PE03TP2	O	A19	
PE03TP3	O	A18	
PE04RN0	I	W4	
PE04RN1	I	Y4	
PE04RN2	I	AB4	
PE04RN3	I	AC4	
PE04RP0	I	W5	
PE04RP1	I	Y5	
PE04RP2	I	AB5	
PE04RP3	I	AC5	
PE04TN0	O	W2	
PE04TN1	O	Y2	
PE04TN2	O	AB2	
PE04TN3	O	AC2	
PE04TP0	O	W1	
PE04TP1	O	Y1	
PE04TP2	O	AB1	
PE04TP3	O	AC1	
PE05RN0	I	AE4	
PE05RN1	I	AF4	
PE05RN2	I	AH4	
PE05RN3	I	AJ4	
PE05RP0	I	AE5	
PE05RP1	I	AF5	
PE05RP2	I	AH5	

Table 28 PES34H16G2 Alphabetical Signal List (Part 4 of 7)

Signal Name	I/O Type	Location	Signal Category
PE05RP3	I	AJ5	PCI Express (cont.)
PE05TN0	O	AE2	
PE05TN1	O	AF2	
PE05TN2	O	AH2	
PE05TN3	O	AJ2	
PE05TP0	O	AE1	
PE05TP1	O	AF1	
PE05TP2	O	AH1	
PE05TP3	O	AJ1	
PE06RN0	I	AL7	
PE06RP0	I	AK7	
PE06TN0	O	AN7	
PE06TP0	O	AP7	
PE07RN0	I	AL13	
PE07RP0	I	AK13	
PE07TN0	O	AN13	
PE07TP0	O	AP13	
PE08RN0	I	D16	
PE08RP0	I	E16	
PE08TN0	O	B16	
PE08TP0	O	A16	
PE09RN0	I	D10	
PE09RP0	I	E10	
PE09TN0	O	B10	
PE09TP0	O	A10	
PE10RN0	I	G4	
PE10RP0	I	G5	
PE10TN0	O	G2	
PE10TP0	O	G1	
PE11RN0	I	N4	
PE11RP0	I	N5	
PE11TN0	O	N2	
PE11TP0	O	N1	
PE12RN0	I	AL19	
PE12RP0	I	AK19	
PE12TN0	O	AN19	

Table 28 PES34H16G2 Alphabetical Signal List (Part 5 of 7)

Signal Name	I/O Type	Location	Signal Category	
PE12TP0	O	AP19	PCI Express (cont.)	
PE13RN0	I	AL25		
PE13RP0	I	AK25		
PE13TN0	O	AN25		
PE13TP0	O	AP25		
PE14RN0	I	AH31		
PE14RP0	I	AH30		
PE14TN0	O	AH33		
PE14TP0	O	AH34		
PE15RN0	I	AB31		
PE15RP0	I	AB30		
PE15TN0	O	AB33		
PE15TP0	O	AB34		
PERSTN	I	B32		System
REFRES00	I/O	R29		SerDes Reference Resistors
REFRES01	I/O	M28		
REFRES02	I/O	H21		
REFRES03	I/O	F19		
REFRES04	I/O	Y7		
REFRES05	I/O	AB6		
REFRES06	I/O	AH14		
REFRES07	I/O	AJ16		
REFRES08	I/O	J15		
REFRES09	I/O	F10		
REFRES10	I/O	R7		
REFRES11	I/O	T9		
REFRES12	I/O	AH20		
REFRES13	I/O	AH23		
REFRES14	I/O	AA29		
REFRES15	I/O	W29		
REFRESPLL	I/O	F17		
RSTHALT	I	AP3	System	

Table 28 PES34H16G2 Alphabetical Signal List (Part 6 of 7)











Signal Name	I/O Type	Location	Signal Category
SSMBADDR1	I	C34	SMBus Interface
SSMBADDR2	I	C33	
SSMBADDR3	I	D33	
SSMBADDR5	I	D32	
SSMBCLK	I/O	H28	
SSMBDAT	I/O	J27	
SWMODE0	I	AN4	System
SWMODE1	I	AP4	
SWMODE2	I	AN5	
SWMODE3	I	AM5	
V <sub>DD</sub> CORE, V <sub>DD</sub> I/O, V <sub>DD</sub> PEA, V <sub>DD</sub> PEHA, V <sub>DD</sub> PETA	See Table 25 for a listing of power pins.		
V <sub>SS</sub>	See Table 26 for a listing of ground pins.		

Table 28 PES34H16G2 Alphabetical Signal List (Part 7 of 7)

PES34H16G2 Pinout — Top View

	1	2	3	4	5	6	7	8	9	10	11	12	13	14	15	16	17	18	19	20	21	22	23	24	25	26	27	28	29	30	31	32	33	34	
A	✓	✓	□	✗	✓	✗	✗	✓	✗	□	✓	✗	✗	✓	✗	□	✓	□	□	✓	□	□	✓	□	□	✓	□	□	✓	✗	□	□	✓	✓	A
B	✗	✗	□	□	✓	✗	✗	✓	✗	□	✓	✗	✗	✓	✗	□	✓	□	□	✓	□	□	✓	□	□	✓	□	□	✓	□	□	✗	✓	B	
C	□	□	□	□	✓	✓	✓	✓	✓	✓	✓	✓	✓	✓	✓	✓	✓	✓	✓	✓	✓	✓	✓	✓	✓	✓	✓	✓	✓	✓	✓	✓	✓	✓	C
D	□	□	✗	□	✓	✗	✗	✓	✗	□	✓	✗	✗	✓	✗	□	✓	□	□	✓	□	□	✓	□	□	✓	□	□	✓	✗	□	□	✗	D	
E	✗	□	□	□	✓	✗	✗	✓	✗	□	✓	✗	✗	✓	✗	□	✓	□	□	✓	□	□	✓	□	□	✓	□	□	✓	✓	✓	✓	✓	E	
F	✓	✓	✓	✓	✓	✓	✓	✓	✓	□	✓	✓	✓	✓	✓	□	✓	□	✓	✓	✓	✓	✓	✓	✓	✓	✓	✓	✓	□	□	✓	□	F	
G	□	□	✓	□	□	✓	✓	✓	✓	✓	✓	✗	✓	✗	✓	□	□	✗	✓	✓	✗	✓	✓	✓	✓	✓	✓	✓	✓	✓	□	□	✓	□	G
H	✗	✗	✓	✗	✗	✓	✓	□	✗	✓	✓	✓	✗	✗	✗	✗	✗	✗	✗	✗	✗	✗	✗	✗	✗	✗	✗	✗	✗	✗	✗	✗	✗	H	
J	✓	✓	✓	✓	✓	✓	✓	□	✓	✓	✓	✓	+	□	✓	+	+	✓	+	+	+	+	+	+	+	+	+	+	+	+	+	+	+	J	
K	✗	✗	✓	✗	✗	✓	✓	✗	□	✓	✓	+	✗	✗	✗	✗	✗	✗	✗	✗	✗	✗	✗	✗	✗	✗	✗	✗	✗	✗	✗	✗	✗	K	
L	✗	✗	✓	✗	✗	✓	✓	✓	✓	✓	+	+	+	+	+	+	+	+	+	+	+	+	+	+	+	+	+	+	+	+	+	+	+	L	
M	✓	✓	✓	✓	✓	✓	✓	✓	✓	✓	✓	+	+	+	+	+	+	+	+	+	+	+	+	+	+	+	+	+	+	+	+	+	+	M	
N	□	□	✓	□	□	✓	✗	+	+	+	+	+	+	+	+	+	+	+	+	+	+	+	+	+	+	+	+	+	+	+	+	+	+	N	
P	✗	✗	✓	✗	✗	✓	✓	+	+	+	+	+	+	+	+	+	+	+	+	+	+	+	+	+	+	+	+	+	+	+	+	+	+	P	
R	✓	✓	✓	✓	✓	□	✗	✗	+	+	+	+	+	+	+	+	+	+	+	+	+	+	+	+	+	+	+	+	+	+	+	+	+	R	
T	✗	✗	✓	✗	✗	✓	✓	□	✓	✓	✓	✓	✓	✓	✓	✓	✓	✓	✓	✓	✓	✓	✓	✓	✓	✓	✓	✓	✓	✓	✓	✓	✓	T	
U	✗	✗	✓	✗	✗	✓	✓	+	+	+	+	+	+	+	+	+	+	+	+	+	+	+	+	+	+	+	+	+	+	+	+	+	+	U	
V	✓	✓	✓	✓	✓	✓	✗	+	+	+	+	+	+	+	+	+	+	+	+	+	+	+	+	+	+	+	+	+	+	+	+	+	+	V	
W	□	□	✓	□	□	✓	✓	✓	✓	✓	✓	✓	✓	✓	✓	✓	✓	✓	✓	✓	✓	✓	✓	✓	✓	✓	✓	✓	✓	✓	✓	✓	✓	W	
Y	□	□	✓	□	□	✗	□	✗	+	+	+	+	+	+	+	+	+	+	+	+	+	+	+	+	+	+	+	+	+	+	+	+	+	Y	
AA	✓	✓	✓	✓	✓	✓	□	+	+	+	+	+	+	+	+	+	+	+	+	+	+	+	+	+	+	+	+	+	+	+	+	+	+	AA	
AB	□	□	✓	□	□	□	✗	+	+	+	+	+	+	+	+	+	+	+	+	+	+	+	+	+	+	+	+	+	+	+	+	+	+	AB	
AC	□	□	✓	□	□	✓	✓	✓	✓	✓	+	+	+	+	+	+	+	+	+	+	+	+	+	+	+	+	+	+	+	+	+	+	+	AC	
AD	✓	✓	✓	✓	✓	✓	✓	✗	✗	✓	✓	+	+	+	+	+	+	+	+	+	+	+	+	+	+	+	+	+	+	+	+	+	+	AD	
AE	□	□	✓	□	□	✓	✓	✗	✓	✓	✗	+	✗	✗	✗	✗	✗	✗	✗	✗	✗	✗	✗	✗	✗	✗	✗	✗	✗	✗	✗	✗	AE		
AF	□	□	✓	□	□	✓	✓	✗	✗	✓	✓	+	✓	✓	+	+	+	+	+	+	+	+	+	+	+	+	+	+	+	+	+	+	+	AF	
AG	✓	✓	✓	✓	✓	✓	□	✗	✓	✓	✓	+	✗	✗	✗	✗	✗	✗	✗	✗	✗	✗	✗	✗	✗	✗	✗	✗	✗	✗	✗	✗	AG		
AH	□	□	✓	□	□	✓	✓	□	✓	✓	□	✓	□	□	✗	□	□	✓	□	□	✓	□	□	✓	□	□	✓	□	□	✓	□	□	□	AH	
AJ	□	□	✓	□	□	✓	✓	✓	✓	✓	✓	✓	✓	✓	✓	✓	✓	✓	✓	✓	✓	✓	✓	✓	✓	✓	✓	✓	✓	✓	✓	✓	✓	AJ	
AK	✓	✓	✓	✓	✓	✓	□	✗	✓	✗	✗	✓	□	✗	✗	✗	✓	□	✗	✗	✗	✓	□	✗	✗	✗	✗	✗	✗	✗	✗	✗	AK		
AL	✗	□	✗	✗	✓	□	✗	✗	✗	✓	□	✗	✗	✗	✓	□	✗	✗	✗	✓	□	✗	✗	✗	✗	✗	✗	✗	✗	✗	✗	✗	AL		
AM	□	✗	✗	✗	□	✓	✓	✓	✓	✓	✓	✓	✓	✓	✓	✓	✓	✓	✓	✓	✓	✓	✓	✓	✓	✓	✓	✓	✓	✓	✓	✓	AM		
AN	✓	✗	✗	□	□	✓	□	✗	✗	✗	✓	□	✗	✗	✗	✓	□	✗	✗	✓	□	✗	✗	✗	✗	✗	✗	✗	✗	✗	✗	✗	AN		
AP	✓	✓	□	□	✗	✓	□	✗	✗	✗	✓	□	✗	✗	✗	✓	□	✗	✗	✓	□	✗	✗	✗	✗	✗	✗	✗	✗	✗	✗	✗	AP		

	V <sub>DD</sub> Core (Power)		V <sub>DD</sub> PETA (Transmitter Power)		Signals
	V <sub>DD</sub> I/O (Power)		V <sub>DD</sub> PEA (Analog Power)		No connect
	V <sub>SS</sub> (Ground)		V <sub>DD</sub> PEHA (High Analog Power)		

PES34H16G2 Package Drawing — 1156-Pin BL1156/BR1156

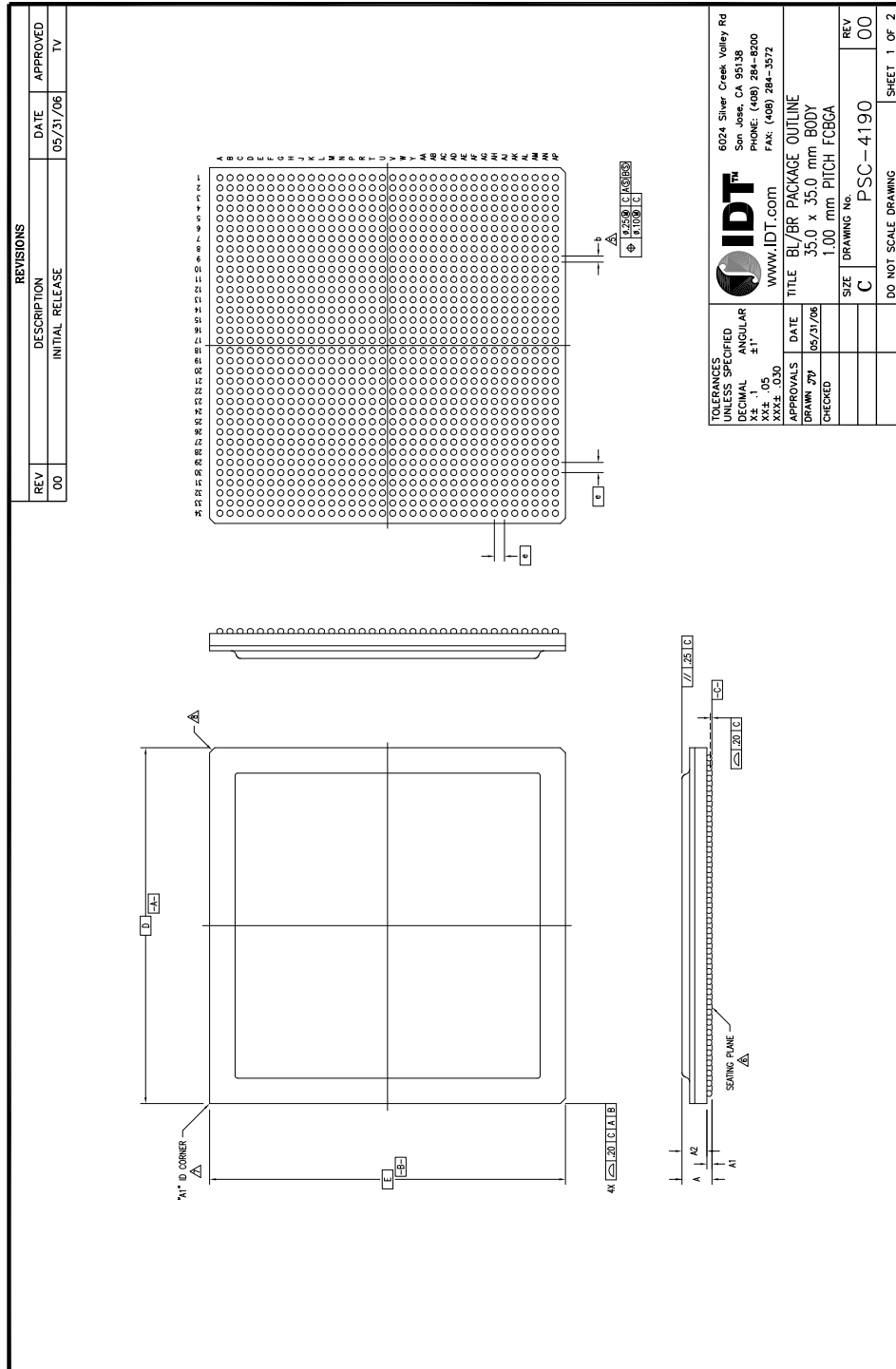

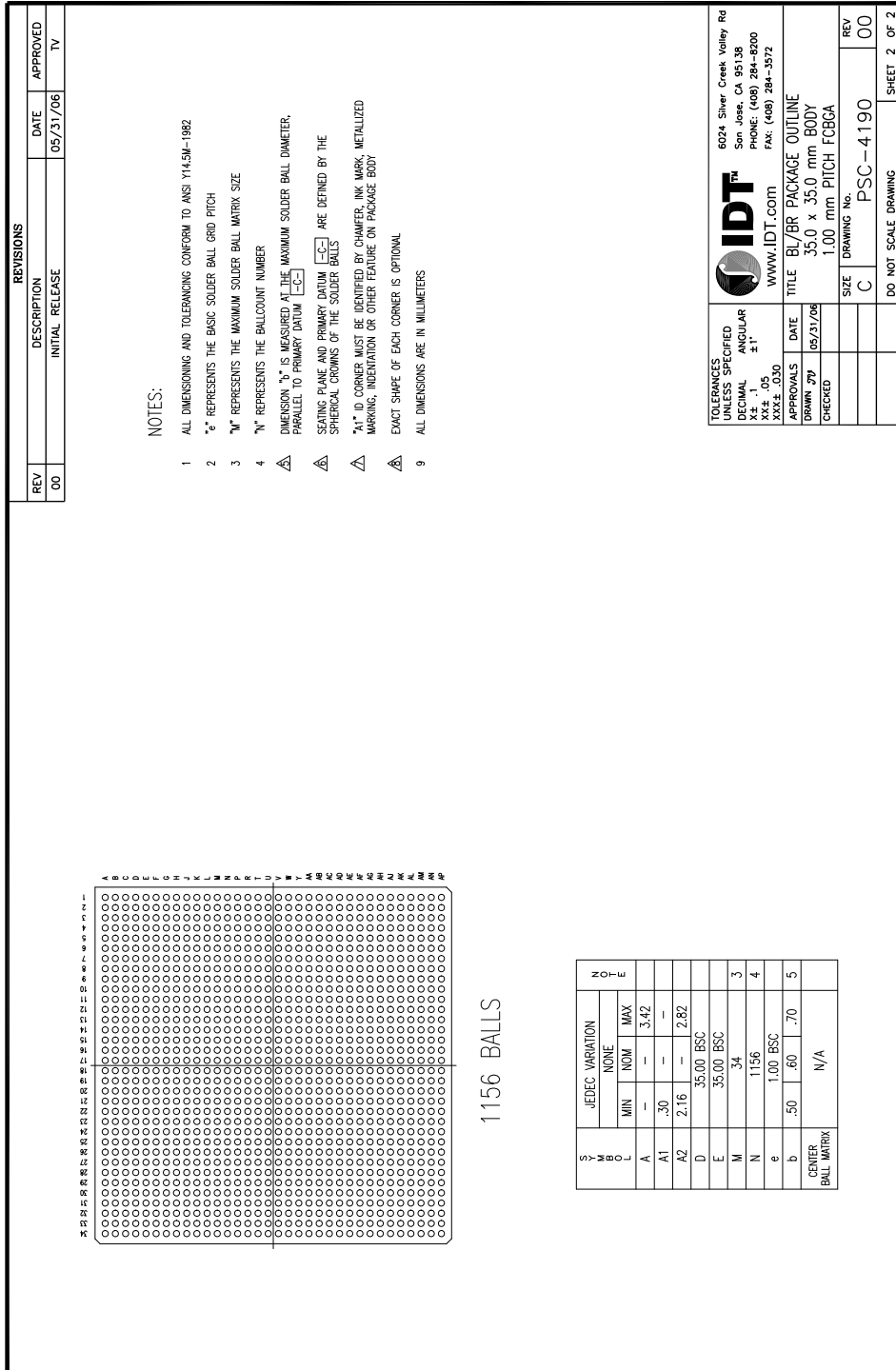

## Revision History

**January 21, 2010:** Publication of Final data sheet.

**March 30, 2011:** In Table 14, added  $V_{DD}PETA$  to footnote #1.

**November 28, 2011:** Added new Tables 21 and 22, SMBus Characterization and Timing.

## Ordering Information

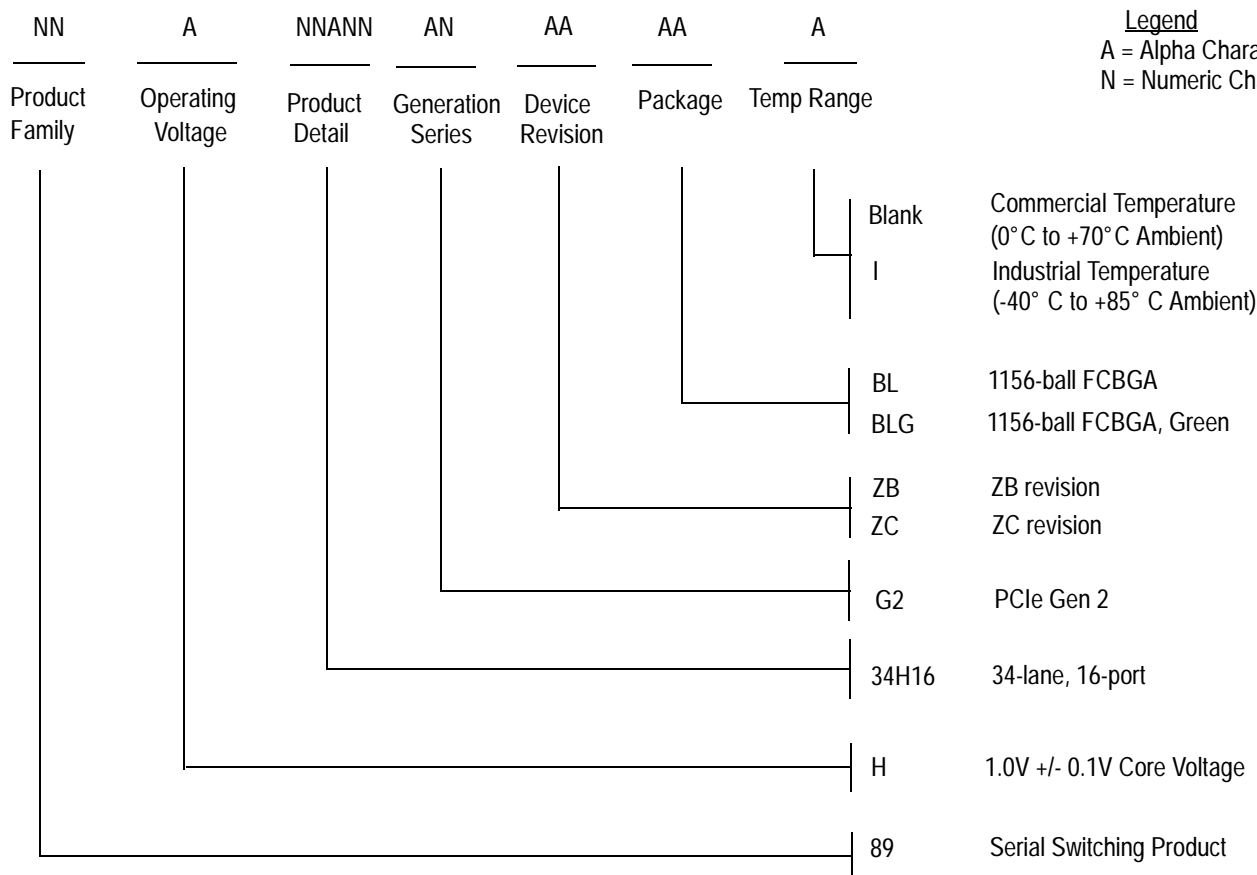

**Legend**  
 A = Alpha Character  
 N = Numeric Character

### Valid Combinations

- 89H34H16G2ZBBL 1156-ball FCBGA package, Commercial Temperature
- 89H34H16G2ZBBLG 1156-ball Green FCBGA package, Commercial Temperature
- 89H34H16G2ZBBLI 1156-ball FCBGA package, Industrial Temperature
- 89H34H16G2ZBBLGI 1156-ball Green FCBGA package, Industrial Temperature
- 89H34H16G2ZCBL 1156-ball FCBGA package, Commercial Temperature
- 89H34H16G2ZCBLG 1156-ball Green FCBGA package, Commercial Temperature
- 89H34H16G2ZCBLI 1156-ball FCBGA package, Industrial Temperature
- 89H34H16G2ZCBLGI 1156-ball Green FCBGA package, Industrial Temperature



**CORPORATE HEADQUARTERS**  
 6024 Silver Creek Valley Road  
 San Jose, CA 95138

**for SALES:**  
 800-345-7015 or 408-284-8200  
 fax: 408-284-2775  
[www.idt.com](http://www.idt.com)

**for Tech Support:**  
 email: [ssdhelp@idt.com](mailto:ssdhelp@idt.com)  
 phone: 408-284-8208

## Notice

1. Descriptions of circuits, software and other related information in this document are provided only to illustrate the operation of semiconductor products and application examples. You are fully responsible for the incorporation or any other use of the circuits, software, and information in the design of your product or system. Renesas Electronics disclaims any and all liability for any losses and damages incurred by you or third parties arising from the use of these circuits, software, or information.
2. Renesas Electronics hereby expressly disclaims any warranties against and liability for infringement or any other claims involving patents, copyrights, or other intellectual property rights of third parties, by or arising from the use of Renesas Electronics products or technical information described in this document, including but not limited to, the product data, drawings, charts, programs, algorithms, and application examples.
3. No license, express, implied or otherwise, is granted hereby under any patents, copyrights or other intellectual property rights of Renesas Electronics or others.
4. You shall not alter, modify, copy, or reverse engineer any Renesas Electronics product, whether in whole or in part. Renesas Electronics disclaims any and all liability for any losses or damages incurred by you or third parties arising from such alteration, modification, copying or reverse engineering.
5. Renesas Electronics products are classified according to the following two quality grades: "Standard" and "High Quality". The intended applications for each Renesas Electronics product depends on the product's quality grade, as indicated below.
  - "Standard": Computers; office equipment; communications equipment; test and measurement equipment; audio and visual equipment; home electronic appliances; machine tools; personal electronic equipment; industrial robots; etc.
  - "High Quality": Transportation equipment (automobiles, trains, ships, etc.); traffic control (traffic lights); large-scale communication equipment; key financial terminal systems; safety control equipment; etc.Unless expressly designated as a high reliability product or a product for harsh environments in a Renesas Electronics data sheet or other Renesas Electronics document, Renesas Electronics products are not intended or authorized for use in products or systems that may pose a direct threat to human life or bodily injury (artificial life support devices or systems; surgical implantations; etc.), or may cause serious property damage (space system; undersea repeaters; nuclear power control systems; aircraft control systems; key plant systems; military equipment; etc.). Renesas Electronics disclaims any and all liability for any damages or losses incurred by you or any third parties arising from the use of any Renesas Electronics product that is inconsistent with any Renesas Electronics data sheet, user's manual or other Renesas Electronics document.
6. When using Renesas Electronics products, refer to the latest product information (data sheets, user's manuals, application notes, "General Notes for Handling and Using Semiconductor Devices" in the reliability handbook, etc.), and ensure that usage conditions are within the ranges specified by Renesas Electronics with respect to maximum ratings, operating power supply voltage range, heat dissipation characteristics, installation, etc. Renesas Electronics disclaims any and all liability for any malfunctions, failure or accident arising out of the use of Renesas Electronics products outside of such specified ranges.
7. Although Renesas Electronics endeavors to improve the quality and reliability of Renesas Electronics products, semiconductor products have specific characteristics, such as the occurrence of failure at a certain rate and malfunctions under certain use conditions. Unless designated as a high reliability product or a product for harsh environments in a Renesas Electronics data sheet or other Renesas Electronics document, Renesas Electronics products are not subject to radiation resistance design. You are responsible for implementing safety measures to guard against the possibility of bodily injury, injury or damage caused by fire, and/or danger to the public in the event of a failure or malfunction of Renesas Electronics products, such as safety design for hardware and software, including but not limited to redundancy, fire control and malfunction prevention, appropriate treatment for aging degradation or any other appropriate measures. Because the evaluation of microcomputer software alone is very difficult and impractical, you are responsible for evaluating the safety of the final products or systems manufactured by you.
8. Please contact a Renesas Electronics sales office for details as to environmental matters such as the environmental compatibility of each Renesas Electronics product. You are responsible for carefully and sufficiently investigating applicable laws and regulations that regulate the inclusion or use of controlled substances, including without limitation, the EU RoHS Directive, and using Renesas Electronics products in compliance with all these applicable laws and regulations. Renesas Electronics disclaims any and all liability for damages or losses occurring as a result of your noncompliance with applicable laws and regulations.
9. Renesas Electronics products and technologies shall not be used for or incorporated into any products or systems whose manufacture, use, or sale is prohibited under any applicable domestic or foreign laws or regulations. You shall comply with any applicable export control laws and regulations promulgated and administered by the governments of any countries asserting jurisdiction over the parties or transactions.
10. It is the responsibility of the buyer or distributor of Renesas Electronics products, or any other party who distributes, disposes of, or otherwise sells or transfers the product to a third party, to notify such third party in advance of the contents and conditions set forth in this document.
11. This document shall not be reprinted, reproduced or duplicated in any form, in whole or in part, without prior written consent of Renesas Electronics.
12. Please contact a Renesas Electronics sales office if you have any questions regarding the information contained in this document or Renesas Electronics products.

(Note1) "Renesas Electronics" as used in this document means Renesas Electronics Corporation and also includes its directly or indirectly controlled subsidiaries.

(Note2) "Renesas Electronics product(s)" means any product developed or manufactured by or for Renesas Electronics.

(Rev.4.0-1 November 2017)

## Corporate Headquarters

TOYOSU FORESIA, 3-2-24 Toyosu,  
Koto-ku, Tokyo 135-0061, Japan  
[www.renesas.com](http://www.renesas.com)

## Contact Information

For further information on a product, technology, the most up-to-date version of a document, or your nearest sales office, please visit:  
[www.renesas.com/contact/](http://www.renesas.com/contact/)

## Trademarks

Renesas and the Renesas logo are trademarks of Renesas Electronics Corporation. All trademarks and registered trademarks are the property of their respective owners.