



Tsi340 Evaluation Board User Manual

80E3000_MA002_02

September 19, 2009

6024 Silver Creek Valley Road San Jose, California 95138

Telephone: (408) 284-8200 • FAX: (408) 284-3572

Printed in U.S.A.

©2009 Integrated Device Technology, Inc.

GENERAL DISCLAIMER

Integrated Device Technology, Inc. ("IDT") reserves the right to make changes to its products or specifications at any time, without notice, in order to improve design or performance. IDT does not assume responsibility for use of any circuitry described herein other than the circuitry embodied in an IDT product. Disclosure of the information herein does not convey a license or any other right, by implication or otherwise, in any patent, trademark, or other intellectual property right of IDT. IDT products may contain errata which can affect product performance to a minor or immaterial degree. Current characterized errata will be made available upon request. Items identified herein as "reserved" or "undefined" are reserved for future definition. IDT does not assume responsibility for conflicts or incompatibilities arising from the future definition of such items. IDT products have not been designed, tested, or manufactured for use in, and thus are not warranted for, applications where the failure, malfunction, or any inaccuracy in the application carries a risk of death, serious bodily injury, or damage to tangible property. Code examples provided herein by IDT are for illustrative purposes only and should not be relied upon for developing applications. Any use of such code examples shall be at the user's sole risk.

Copyright © 2009 Integrated Device Technology, Inc.
All Rights Reserved.

The IDT logo is registered to Integrated Device Technology, Inc. IDT is a trademark of Integrated Device Technology, Inc.

1. Tsi340 Evaluation Board User Manual

This document explains the design and layout of the *Tsi340 Evaluation Board User Manual*. The following topics are discussed:

- “Overview” on page 3
- “Board Design” on page 5
- “Board Layout” on page 11
- “Build of Materials (BOM)” on page 18

Revision History

80E3000_MA002_02, Formal, September 2009

This document was rebranded as IDT. It does not include any technical changes.

80E3000_MA002_01, Formal, May 2007

This is the first version of this document.

Related Documents

Tsi340 Evaluation Board Schematics

1.1 Overview

This document is divided in two sections: board design and board layout. In board design, the components on the board and board functionary are explained. In the board layout section the component placement and the setting options are explained.

1.1.1 Evaluation Board Part Number

The Tsi340 evaluation board part number is Tsi340-RDK1 V1.0. The assembly number of the board is E3000_AS001.

1.1.2 Functional Description

This section describes the components on the evaluation board.

1.1.2.1 Tsi340 PCI-to-PCI Bridge

- Primary PCI: 32bit, 66MHz
- Secondary PCI: 32bit, 66MHz
- Clocking Mode: Synchronized primary and secondary clocking
- Signal Standard: 3.3V LVTTL with 5V tolerance
- Supply Voltage: 3.3V
- Package: FQFP-128pin

1.1.2.2 Primary PCI Connector

- 32-bit universal PCI finger connector
- Support both 3.3 V and 5 V PCI slot
- Compliant with *PPCI Specification (Revision 2.3)*
- VIO pins are not supported

1.1.2.3 Secondary PCI Connector

- Four 3.3 V, 32 bit, PCI connector slots
- PCI clocking generated from Tsi340
- Compliant with *PCI Specification (Revision 2.3)*

1.1.2.4 Board Form Factor

- Form Factor: 4-layers Micro ATX Add-in Card with extended height
- Size: ~5.5" x 7.5"

1.1.2.5 Power Supply

- PCI Finger Edge Connector: +3.3 V, +5 V, +12 V, -12 V
- Maximum Power Consumption: 25 W

2. Board Design

The following sections explain the design of the evaluation board, its components, and their functionality.

2.1 Overview

The Tsi340 PCI-to-PCI bridge evaluation board has the necessary functionality to evaluate all the features of the Tsi340. The primary PCI side of the Tsi340 is wired to a PCI finger connector. The secondary PCI side is wired to four, 32-bit, 3.3 V PCI connectors. **Figure 1** shows the board block diagram.



Many features can be exercised with shunt jumpers and switches.

Figure 1: Board Block Diagram

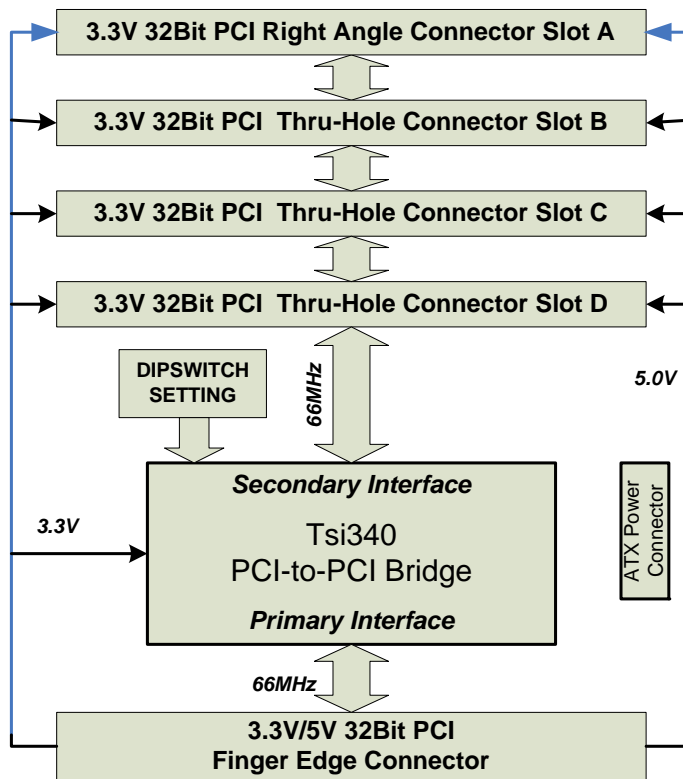

2.2 Clocking

Tsi340 is a synchronous device, where the secondary clock outputs are synchronous to the primary clock input.

Figure 2 shows the PCI clocking connection.

Figure 2: Clock Signals

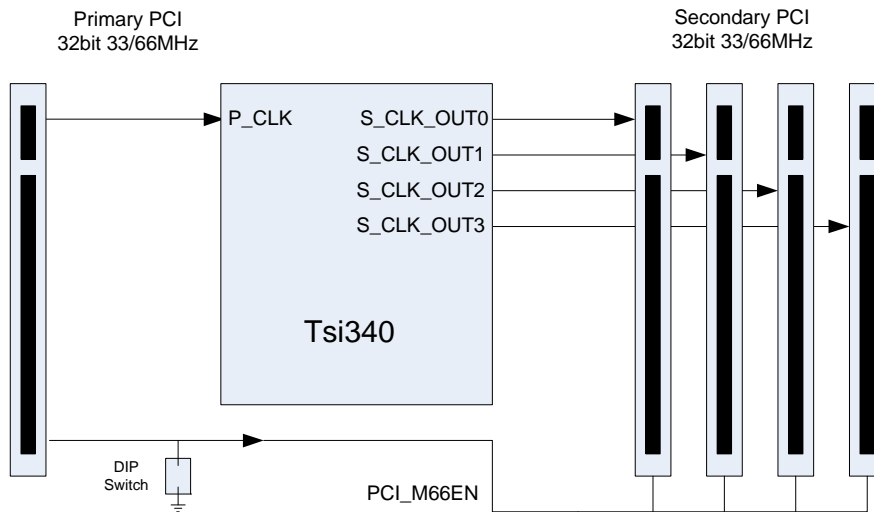

2.2.1 Domains

Primary and secondary clocking domains are described in the following sections.

2.2.1.1 Primary PCI Clock Domain

The primary clock is sourced from a PCI host. It must be synchronous with the primary PCI bus (according to the *PCI Specification (Revision 2.3)*)

The PCI host sets the clock frequency based on its M66EN signal level. However, the Tsi340 evaluation board has the option of forcing the PCI host's M66EN signal low with a DIP switch setting on S1. Refer to “[DIP Switch Package/ Individual Switch Position](#)” on page 14 for more information.

2.2.1.2 Secondary PCI Clock Domain

Tsi340 has four secondary clock outputs, which provide PCI_CLKin for four on-board PCI connectors. The secondary clock outputs are derived from the primary PCI clock input.

2.2.2 M66EN Signal

The M66EN signal from the primary side PCI finger connector is directly routed to four on-board PCI connectors. A DIP switch is attached to M66EN that is used to force M66EN to ground so that the 33 MHz PCI clock can be set. Refer to “[DIP Switch Package/ Individual Switch Position](#)” on page 14 for more information.

2.3 Arbitration

The Tsi340 has a built-in PCI arbiter for the secondary bus. The arbitration signals are connected to the four PCI connectors on the board. [Table 1](#) shows the Tsi340 arbitration signal assignment to each of connectors.

Table 1: Arbitration Assignment

Tsi340 REQ/GNT Signals	Connector
0	J4
1	J3
2	J2
3	J1

2.4 Power

The maximum current draw per rail for the bridge board with no cards plugged-in is indicated in [Table 2](#).

Table 2: Maximum Current Draw with No Plug-in Card

Rail	Current
-12 V	0A
+12 V	0A
5 V	0A
3.3 V	<750mA
3.3 VAUX	0A

2.4.1 Finger Connector Current Limit

When plug-in cards are added to the Tsi340 evaluation board, the current draw must not exceed the capacity of the finger connector. The maximum current draw per rail for the bridge board with cards plugged-in is indicated in [Table 3](#).

The system user must limit its total power consumption to 25W budget from all power rails on the primary finger connector based on PCI specification

Table 3: Maximum Current Draw Per Rail

Rail	Current	Power
-12V	100 mA	1.2 W
+12V	500 mA	6 W
5V	5 A	25 W
3.3V	7.6 A	25 W
3.3VAUX	375 mA	1.2 W

2.4.1.1 Optional ATX Power Connector

If the total power requirement of plug-in cards exceed the current draw as indicated in [Table 3](#), an auxiliary ATX power supply may be used to augment the power capacity of the system. The bridge board has an ATX power supply connector assembly option.

The ATX connector is usually not installed.



If the optional ATX power connector is used, the ATX power supply and PCI finger connector supply must come from the same supply source.

2.4.2 Tsi340 Core Voltage Isolation

The Tsi340 supply voltage plane on the PCB can be isolated from the board’s 3.3 V plane. This feature is used to evaluate the current draw of the PCI bridge. The connection from the Tsi340 supply to the board 3.3 V is done through three 0 Ohm resistors: R5, R6, R7. Current measurement can be done by removing the resistors and insert an amp meter between the resistor pads on the PCB.

2.4.3 PRSNT Pin Power Setting on Primary PCI

The finger connector PRSNT[1:2] pins are wired to indicate a power requirement of 25 W. This is the maximum power the PRSNT[1:2] pins can indicate for an add-in card. The PRSNT pin on the secondary side connectors is not used.

2.4.4 Primary and Secondary Side VIO

The bridge board can plug into a 3.3 V or 5 V system. The primary side input/output signalling uses the same voltage as the system. The secondary side voltage is independent of the primary side voltage. The secondary side signalling voltage is hard-wired to 3.3 V. If 5 V signalling is required on the secondary side, the PCB assembly must be modified in the following ways:

- Remove the R1, R2, R3 resistors
- Solder jumper wires (AWG22) between the 5V test pads and the SVIO test pads.

Figure 3: Modified PCB Traces for 5 V Signaling on Secondary PCI Bus

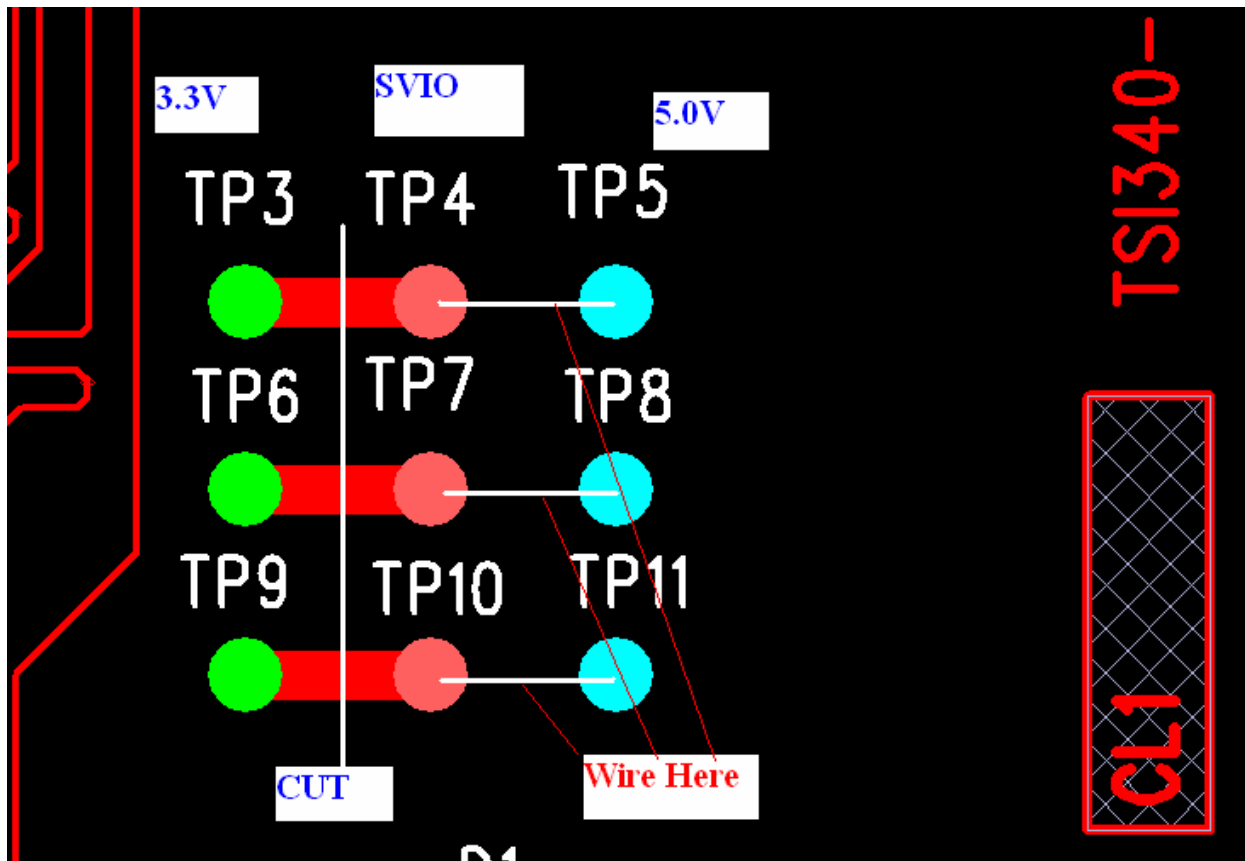

2.5 Interrupts and IDSEL

The add-in card interrupts are routed directly to the PCI system host. The Tsi340 is not involved with interrupt routing. The connection of the interrupt lines from the PCI connectors to the finger connector is arranged so that Int A of each PCI connector is routed to a different interrupt on the finger connector. Add-in card are numbered using AD[24:27] lines. Table 4 maps the interrupt connections designation and AD line connections.

Table 4: Interrupt and IDSEL Mapping

Finger Connector Interrupt	J1/AD27	J2/AD24	J3/AD25	J4/AD26
Int A	Int B	Int A	Int D	Int C
Int B	Int C	Int B	Int A	Int D
Int C	Int D	Int C	Int B	Int A
Int D	Int A	Int D	Int C	Int B

Table 5 shows the IDSEL assignments.

Table 5: Interrupt and IDSEL Mapping

Slot Number	Bus Arbitration	IDSEL	Device ID	INTA Routing to Primary PCI
J1	REQ3/GNT3	IS_AD27	0xB	P_INTB
J2	REQ2/GNT2	IS_AD26	0xA	P_INTC
J3	REQ1/GNT1	IS_AD25	0x9	P_INTD
J4	REQ0/GNT0	IS_AD24	0x8	P_INTA

2.6 Resets

Tsi340 is reset from the system host reset signal (from the finger connector). The secondary side reset is driven by Tsi340. There is no manual reset on the board.

3. Board Layout

In the board layout section of this document the component placement and the setting options are explained.

3.1 PCB Layers

The Tsi340 Printed Circuit Board (PCB) stack up is made of the following four layers:

- Layer 1: PCB primary side (where most traces are routed)
- Layer 2: Ground plane
- Layer 3: Power plane
- Layer 4: Secondary side

Figure 4 shows the four layers of the PCB.

Figure 4: PCB Stack Up

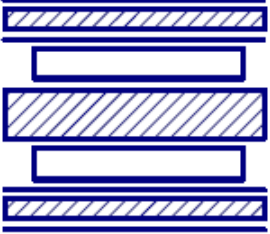
LAYERS	THKS		LAYER TYPE	LAYER DEFINITION	STRIPLINE		EDGE COUPLED DIFF	
					TRACE WIDTH	IMPEDANCE	TRACE WIDTH	IMPEDANCE
LAYER 1	2.2		MASK PLATING	PRIMARY	5	60 OHMS		
LAYER 2	5.1		.5 oz FOIL					
	1.3		PREPREG	PLANE				
	20		1 oz CORE					
	5.2	PREPREG						
LAYER 3	20		CORE	PLANE				
	1.3		1 oz					
LAYER 4	5.1		PREPREG	SECONDARY	5	60 OHMS		
	2.2		.5 oz FOIL MASK PLATING					
ASPECT RATIO :			6.3					
SUBSTRATE :			FR4 N4000-6FC					
THICKNESS :			63 MILS +/- 10%					

NOTES:

1. MATERIAL - FR4 N4000-6FC (REF IPC-6012)

3.2 Board Dimensions

The board dimensions are based on PCI standard for a 32-bit Variable Height Short Add-in card. However, the height of the card exceeds the maximum specified in the standard. The board dimensions are shown in [Figure 5](#).

Figure 5: Board Dimensions

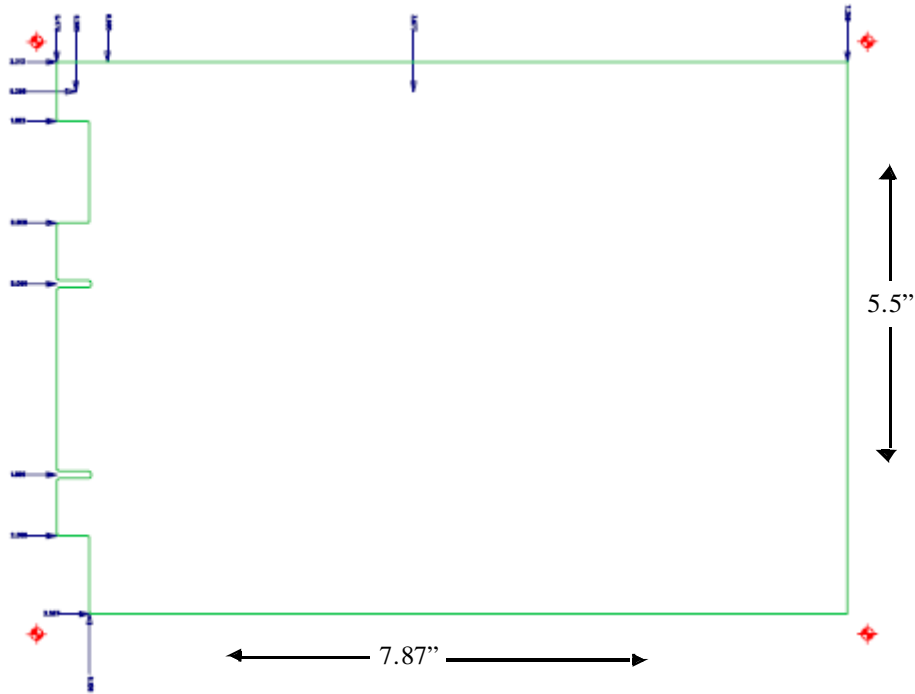

3.3 Component Placement

The placement of the components, jumpers, and switches are shown in **Figure 6**.

Figure 6: Component Placement

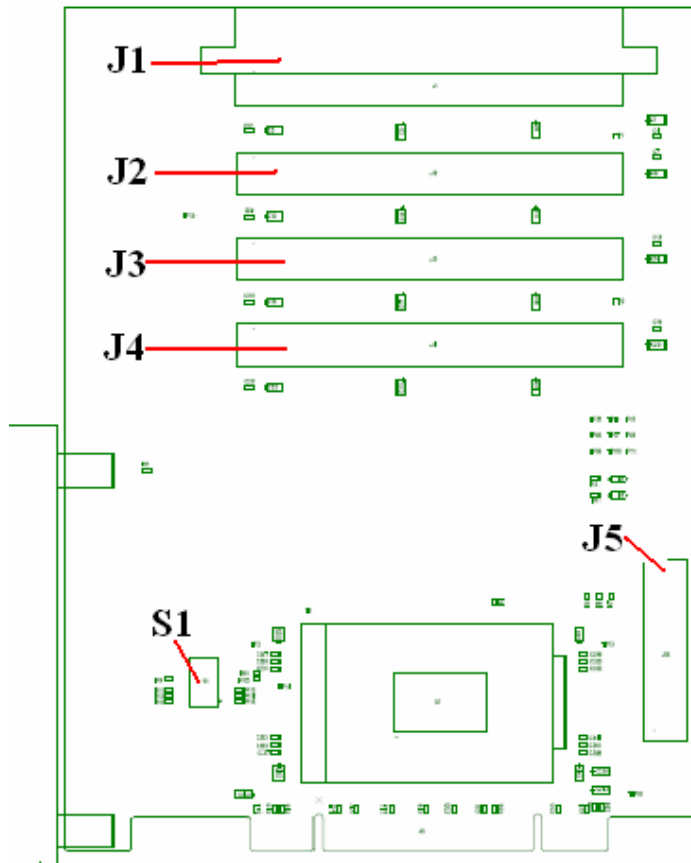

3.4 Switches

DIP switch S1 has eight slide switches, which are identified with numbers 1-to-8.

Figure 7: DIP Switch Package/ Individual Switch Position

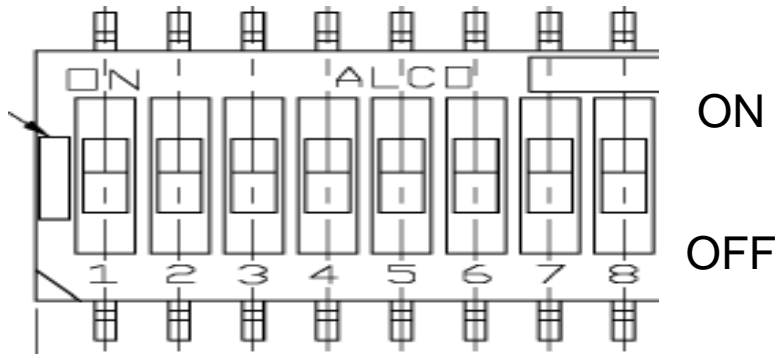

Table 6 describes the settings for the S1 DIP switch..

Table 6: DIP Switch S1 Settings

S1	Description	Default	On/Off setting
1	Tsi340 P_CLKRUN# input pin connection	ON	ON: P_CLKRUN# is pulled down for normal operation. OFF: P_CLKRUN# is pulled up for test purpose only.
2	Tsi340 LOO pin connection	OFF	ON: LOO is held low for test purpose only. OFF: LOO is pulled up for normal operation.
3	P_RST# signal level	OFF	ON: Force P_RST# to low for test purpose only. OFF: Normal operation.
4	PCI_M66EN# signal level	OFF	ON: Force PCI_M66EN to low for 33MHz clocking operation OFF: Normal operation (PCI clock frequency is determined by primary PCI_CLKin and PCI_M66EN# signal level from the secondary plug-in cards)
5	Tsi340 S_CLKRUN# input pin connection	ON	ON: S_CLKRUN# is pulled down for normal operation. OFF: S_CLKRUN# is pulled up for test purpose only.
6	Unused	OFF	OFF
7	Unused	OFF	OFF
8	Unused	OFF	OFF

3.5 Connectors

Board connectors are used to add cards and power supplies to the Tsi340 board.

3.5.1 J1 through J4 Connectors - PCI Plug-in Card

J1, J2, J3, J4 are used to connect plug-in card on Tsi340's secondary PCI side. The connector's pin assignment is standard PCI 32-bit, 3.3 V connectors.

3.5.2 J5 - ATX Power Connector (Not Installed)

This connector is not installed on the Tsi340 board. This connector is only required if the voltage drop at the plug-in card is to high. Table 11 shows the pin assignments for the J5 connector.

Table 7: J7 Pin Assignment

Pin	Signal Assignment	J7 pin location
1	3.3V	
2	3.3V	
3	GND	
4	5V	
5	GND	
6	5V	
7	GND	
8	N/C	
9	N/C	
10	12V	
11	3.3V	
12	-12V	
13	GND	
14	GND	
15	GND	
16	GND	
17	GND	
18	N/C	
19	5V	
20	5V	

3.5.3 Finger connector

The pin assignment for the finger connector are standard PCI 32-bit universal connectors.



The Finger connector JTAG signals TDI and TDO are connected together on the board.

3.6 LEDs

The LEDs on the board are used to identify the board activity shown in [Table 8](#).

Table 8: LED description

LED Designation	Signal Assignment	Description
D1	5 V supply	ON: 5 V supply is present
D2	3.3 V supply	ON: 3.3 V supply is present

3.7 Test Points

Test points are provided on the Tsi340 board to facilitate signal probing.

3.7.1 Test Point for Clocks

The Tsi340 secondary clock outputs that are not used are brought out to test points. The clock test points are listed in [Table 9](#).

Table 9: Test Point for Clocks

Test point	Signal Assignment
TP1	Ground
TP2	Ground
TP12	Ground
TP13	Ground
TP15	Ground
TP18	Ground

3.7.2 Test Point for Secondary VIO

The bridge board can plug into a 3.3 V or 5 V systems. The primary side input/output signaling uses the same voltage as the system. The secondary side voltage is independent of the primary side voltage.

4. Build of Materials (BOM)

Table 10: Tsi340 Evaluation Manual Build of Material

Item	RefDes	Part Number	Manufacturer	Description
1	C1,C3,C5-6,C8, C10-12,C14,C16-18, C20,C22-26,C39-43	TAJA106K016	AVX	TANT SMT, 10UF, +/-10%, 16V, 3216-18
2	C2,C4,C7,C9,C13, C15,C19,C21, C27-28,C33-34,C44, C57-59,C61-63, C66-68,C70-72, C74, C78-79,C83	06033D104MAT2A	AVX	X5R CER SMT, 0.1UF, +/-20%, 25V, 0603
3	C29,C32,C35-36, C45-56,C75,C77, C80,C84-99	0603ZC103K	AVX	X7R CER SMT, 0.01UF, +/-10%, 10V, 0603
4	C30-31,C37-38,C73, C76,C81-82	GRM188R71H102MA01D	MURATA	X7R CER SMT, 0.001UF, +/-20%, 50V, 0603
5	C60,C64-65,C69	0603ZD105KAT2A	AVX	X5R CER SMT, 1UF, +/-10%, 10V, 0603
6	D1-2	HSMG-C150	AGILENT	GREEN LED, UNTINTED, DIFFUSED
7	J1	RBB60DHAS-S793	SULLINS	PCI 3.3V, 32BIT, RIGHT ANGLE, 100MIL ROW-TO-ROW
8	J2-4	145154-4	AMP	PCI MOTHERBOARD, 32BIT, 3.3V, THRU
9	J5	39-29-9202	MOLEX	ATX PWR JACK, 0.165" PITCH, MINI-FIT JR
10	R1	ERJ-3EKF1103V	PANASONIC	RES SMT, 110K OHM, 0.1W, 1%, 0603
11	R2-3,R28,R31,R35, R39	ERJ-3GEYJ151V	PANASONIC	RES SMT, 150 OHM, 0.1W, 5%, 0603
12	R4,R8, R10,R12, R14, R16,R18-27,R29-30, R32-34,R36-38, R40-42	ERJ-3GEYJ472V	PANASONIC	RES SMT, 4.7 KOHM, 0.1W, 5%, 0603
13	R5-7,R17,R47	9C06031A0R00JLHFT	YAGEO	RES SMT, 0 OHM, 0.1W, 5%, 0603
14	R9,R11,R13,R15	ERJ-3GEYJ301V	PANASONIC	RES SMT, 300 OHM, 0.1W, 5%, 0603

Table 10: Tsi340 Evaluation Manual Build of Material

Item	RefDes	Part Number	Manufacturer	Description
15	R43-46	ERJ-3GEYJ330V	PANASONIC	RES SMT, 33 OHM, 0.1W, 5%, 0603
16	S1	2-1437590-2	TYCO	DIPSWITCH,8SWITCHES
17	TP1-16	TESTPOINT	IDT	Test points
18	U1	TSI340-66CQ	IDT	PCI TO PCI BRIDGE, 32BITS/66MHZ

IMPORTANT NOTICE AND DISCLAIMER

RENESAS ELECTRONICS CORPORATION AND ITS SUBSIDIARIES (“RENESAS”) PROVIDES TECHNICAL SPECIFICATIONS AND RELIABILITY DATA (INCLUDING DATASHEETS), DESIGN RESOURCES (INCLUDING REFERENCE DESIGNS), APPLICATION OR OTHER DESIGN ADVICE, WEB TOOLS, SAFETY INFORMATION, AND OTHER RESOURCES “AS IS” AND WITH ALL FAULTS, AND DISCLAIMS ALL WARRANTIES, EXPRESS OR IMPLIED, INCLUDING, WITHOUT LIMITATION, ANY IMPLIED WARRANTIES OF MERCHANTABILITY, FITNESS FOR A PARTICULAR PURPOSE, OR NON-INFRINGEMENT OF THIRD PARTY INTELLECTUAL PROPERTY RIGHTS.

These resources are intended for developers skilled in the art designing with Renesas products. You are solely responsible for (1) selecting the appropriate products for your application, (2) designing, validating, and testing your application, and (3) ensuring your application meets applicable standards, and any other safety, security, or other requirements. These resources are subject to change without notice. Renesas grants you permission to use these resources only for development of an application that uses Renesas products. Other reproduction or use of these resources is strictly prohibited. No license is granted to any other Renesas intellectual property or to any third party intellectual property. Renesas disclaims responsibility for, and you will fully indemnify Renesas and its representatives against, any claims, damages, costs, losses, or liabilities arising out of your use of these resources. Renesas' products are provided only subject to Renesas' Terms and Conditions of Sale or other applicable terms agreed to in writing. No use of any Renesas resources expands or otherwise alters any applicable warranties or warranty disclaimers for these products.

(Rev.1.0 Mar 2020)

Corporate Headquarters

TOYOSU FORESIA, 3-2-24 Toyosu,
Koto-ku, Tokyo 135-0061, Japan
www.renesas.com

Contact Information

For further information on a product, technology, the most up-to-date version of a document, or your nearest sales office, please visit:
www.renesas.com/contact/

Trademarks

Renesas and the Renesas logo are trademarks of Renesas Electronics Corporation. All trademarks and registered trademarks are the property of their respective owners.