

REVISIONS HISTORY			
DATE CREATED	REV	DESCRIPTION	AUTHOR
11/02/16	00	INITIAL RELEASE	CM
NOTE: REFER TO DCP FOR OFFICIAL RELEASE DATE			

NOTES:

1. ALL DIMENSIONS AND TOLERANCES ARE PER ASME Y14.5M-1994.
 2. ALL DIMENSIONS ARE IN MILLIMETERS.
- △ SEATING PLANE AND PRIMARY DATUM -C- ARE DEFINED BY THE CONTACT POINTS OF THREE OR MORE SOLDER BALLS THAT SUPPORT THE DEVICE WHEN PLACED ON A TOP OF A PLANAR SURFACE.
 - △ BOTTOM PIN#1 INDICATOR OPTIONAL.

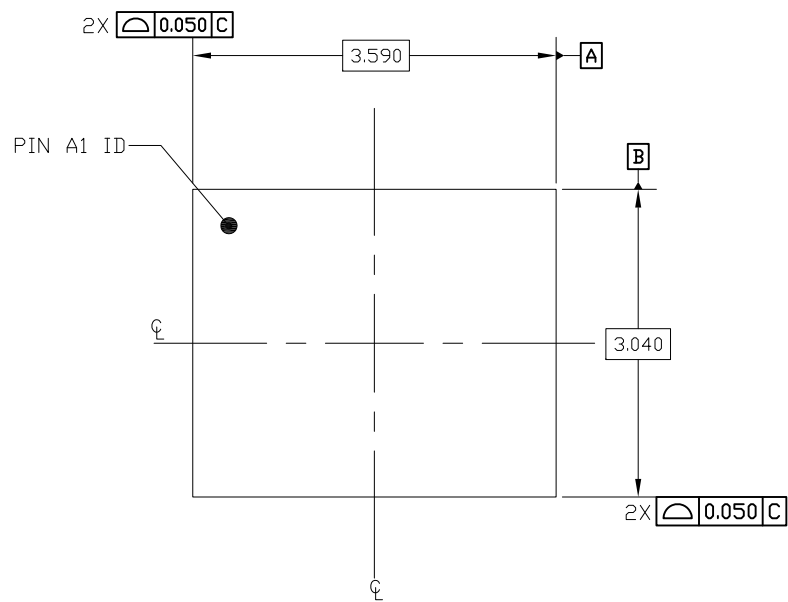

TOP VIEW

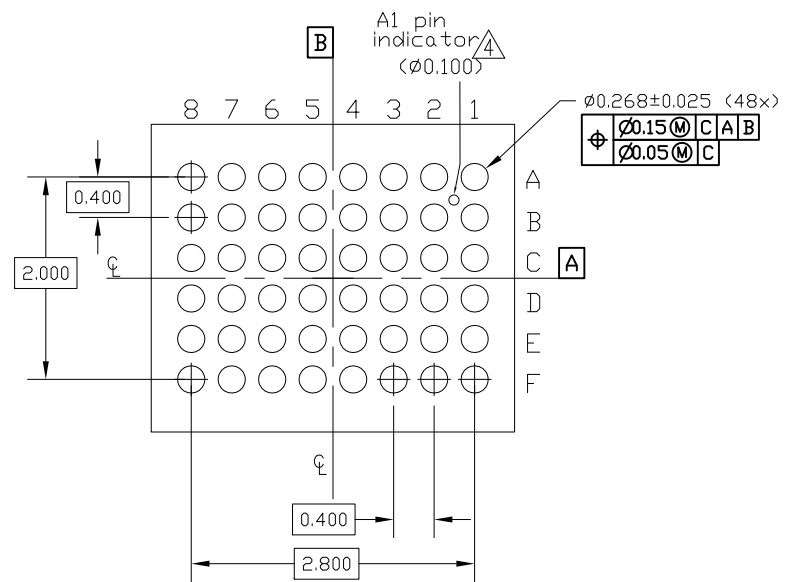
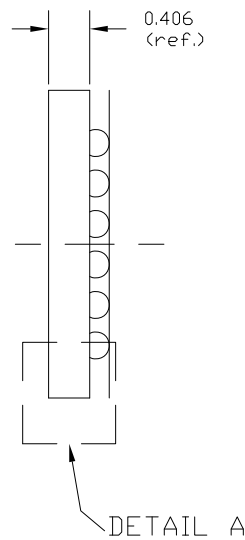

BOTTOM VIEW

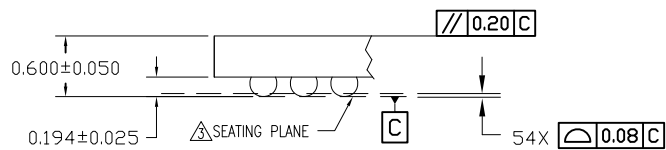

DETAIL A
(ROTATED 90 DEG CW)

TOLERANCES UNLESS OTHERWISE SPECIFIED		 6024 Silver Creek Valley Road, San Jose, CA 95138 PHONE: (408) 284-8200 FAX: (408) 284-3572
DECIMAL :	.X ± .XX ± .XXX ±	
ANGLE :	±	
ANGULAR :	±	
TITLE AHG48 PACKAGE OUTLINE 3.590x3.040mm BODY 0.4mm PITCH DSBGA		
SIZE	DRAWING No.	REV
C	PSC-4669	00
DO NOT SCALE DRAWING		SHEET 1 OF 2

DATE CREATED	REVISIONS HISTORY		
	REV	DESCRIPTION	AUTHOR
11/02/16	00	INITIAL RELEASE	CM
NOTE: REFER TO DCP FOR OFFICIAL RELEASE DATE			

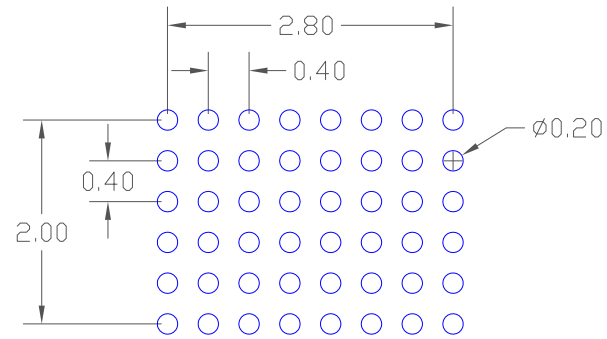

RECOMMENDED LAND PATTERN DIMENSION

NOTE:

1. ALL DIMENSIONS ARE IN MM, ANGLES IN DEGREES.
2. TOP DOWN VIEW, AS VIEW ON PCB.
3. NSMD LAND PATTERN ASSUMED.
4. LAND PATTERN RECOMMENDATION AS PER IPC-7351
GENERIC REQUIREMENT FOR SURFACE MOUNT DESIGN AND LAND PATTERN.

TOLERANCES UNLESS OTHERWISE SPECIFIED DECIMAL : .X * .XX * .XXX * ANGLE : * ANGULAR : *		 6024 Silver Creek Valley Road, San Jose, CA 95138 PHONE: (408) 284-8200 FAX: (408) 284-3572 www.IDT.com	
TITLE AHG48 PACKAGE OUTLINE 3.590x3.040mm BODY 0.4mm PITCH DSBGA			
SIZE	DRAWING No.	REV	
C	PSC-4669	00	
DO NOT SCALE DRAWING			SHEET 2 OF 2