

NOTES:

1. ALL DIMENSIONS AND TOLERANCES ARE PER ASME Y14.5M-1994.
2. ALL DIMENSIONS ARE IN MILLIMETERS.
3. SEATING PLANE AND PRIMARY DATUM -C- ARE DEFINED BY THE CONTACT POINTS OF THREE OR MORE SOLDER BALLS THAT SUPPORT THE DEVICE WHEN PLACED ON A TOP OF A PLANAR SURFACE.
4. BOTTOM PIN#1 INDICATOR OPTIONAL.

DATE CREATED		REVISIONS		
REV	DESCRIPTION	AUTHOR		
00	INITIAL RELEASE	JH		
01	CHANGE BALL SIZE LAND PATTERN DIMENSION	JH		

NOTE: REFER TO DCP FOR OFFICIAL RELEASE DATE

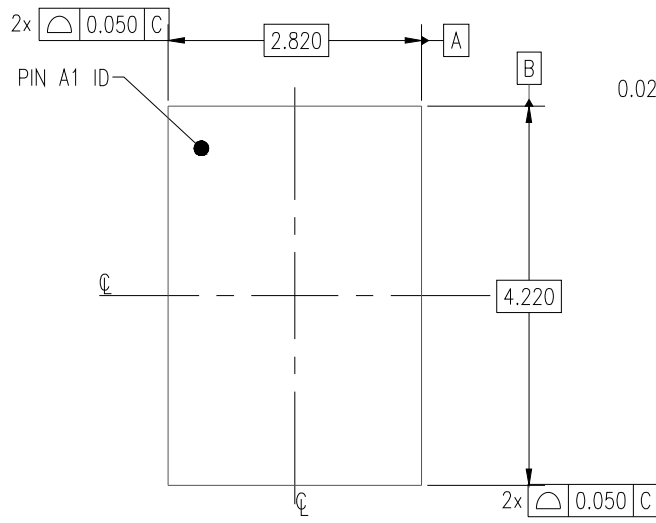

TOP VIEW

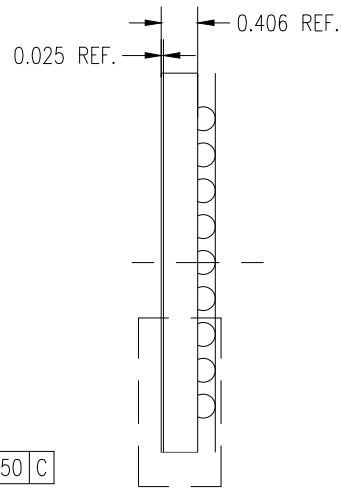

SIDE VIEW

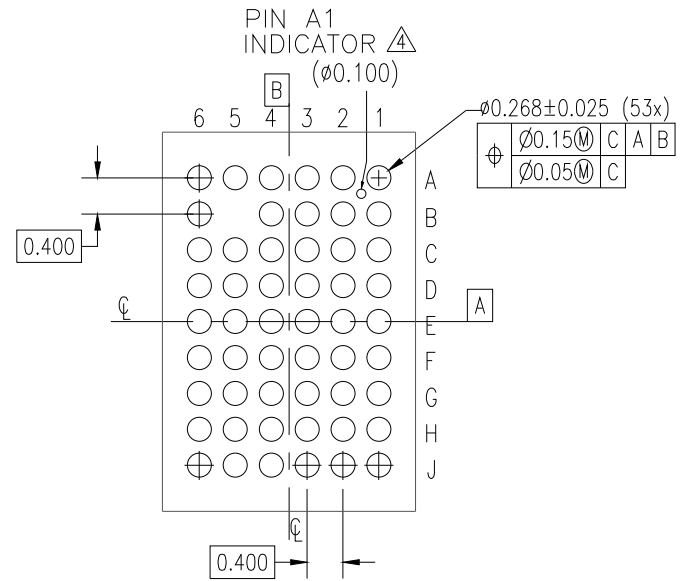

BOTTOM VIEW

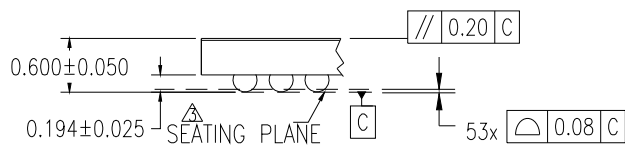

DETAIL A
(ROTATED 90 DEG CW)

TOLERANCES UNLESS SPECIFIED DECIMAL ANGULAR XX± 0.05 ± XXX± 0.012 XXXX±		6024 SILVER CREEK VALLEY ROAD, SAN JOSE, CA 95138 PHONE: (408) 284-8200 FAX: (408) 284-3572	
		www.IDT.com	
TITLE AWR53 Package Outline Drawing 2.820 x 4.220 x 0.600 mm Body 0.4mm Pitch DSBGA			
SIZE C	DRAWING No. PSC-4792	REV 01	
DO NOT SCALE DRAWING			SHEET 1 OF 2

DATE CREATED	REVISIONS		
	REV	DESCRIPTION	AUTHOR
1/21/19	00	INITIAL RELEASE	JH
4/29/19	01	CHANGE BALL SIZE LAND PATTERN DIMENSION	JH

NOTE: REFER TO DCP FOR OFFICIAL RELEASE DATE

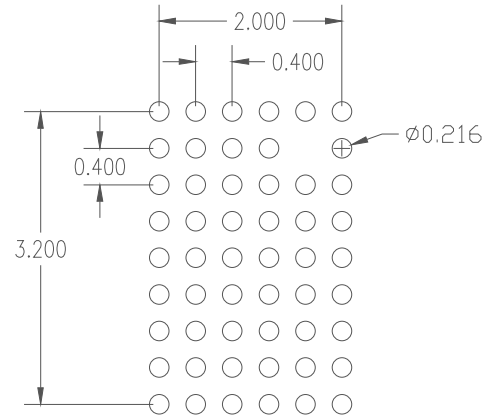

RECOMMENDED LAND PATTERN DIMENSION

NOTE:

1. ALL DIMENSIONS ARE IN MM, ANGLES IN DEGREES.
2. TOP DOWN VIEW, AS VIEW ON PCB.
3. NSMD LAND PATTERN ASSUMED.
4. LAND PATTERN RECOMMENDATION AS PER IPC-7351
GENERIC REQUIREMENT FOR SURFACE MOUNT DESIGN AND LAND PATTERN.

TOLERANCES UNLESS SPECIFIED DECIMAL ANGULAR XX ± 0.05 ± XXX ± 0.012 XXXX ±		 IDT™ www.IDT.com	6024 SILVER CREEK VALLEY ROAD, SAN JOSE, CA 95138 PHONE: (408) 284-8200 FAX: (408) 284-3572	
TITLE ANR53 Package Outline Drawing 2.820 x 4.220 x 0.600 mm Body 0.4mm Pitch DSBGA			SIZE C	DRAWING No. PSC-4792
DO NOT SCALE DRAWING			SHEET 2 OF 2	