

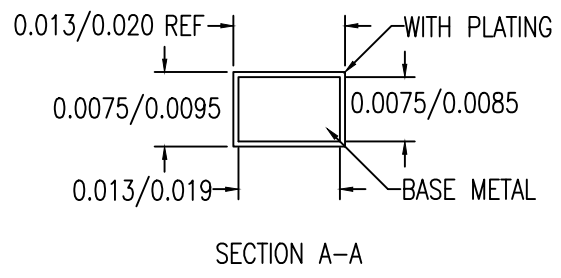

DATE		REVISIONS		AUTHOR
CREATED	REV	DESCRIPTION		
7/26/18	00	INITIAL RELEASE, REVISE FROM PSC-4068-01		RC
NOTE: REFER TO DCP FOR OFFICIAL RELEASE DATE				

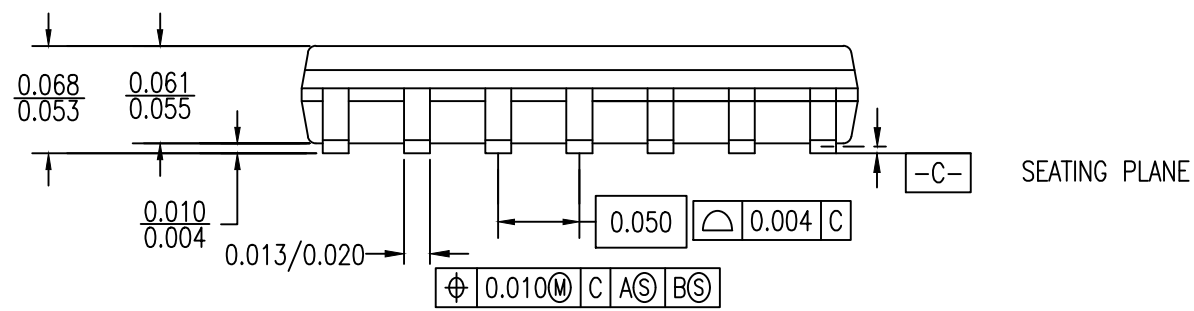
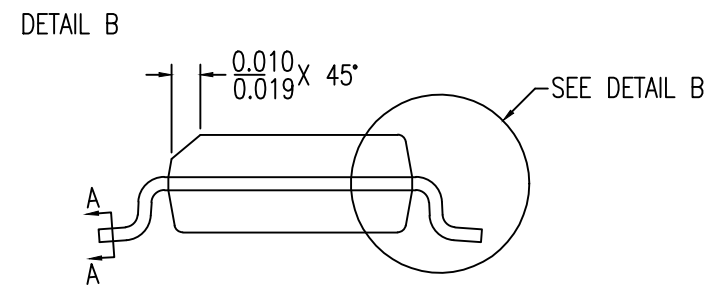
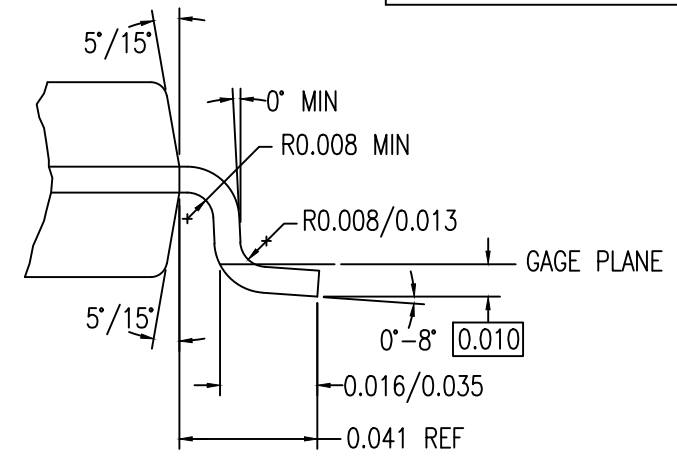
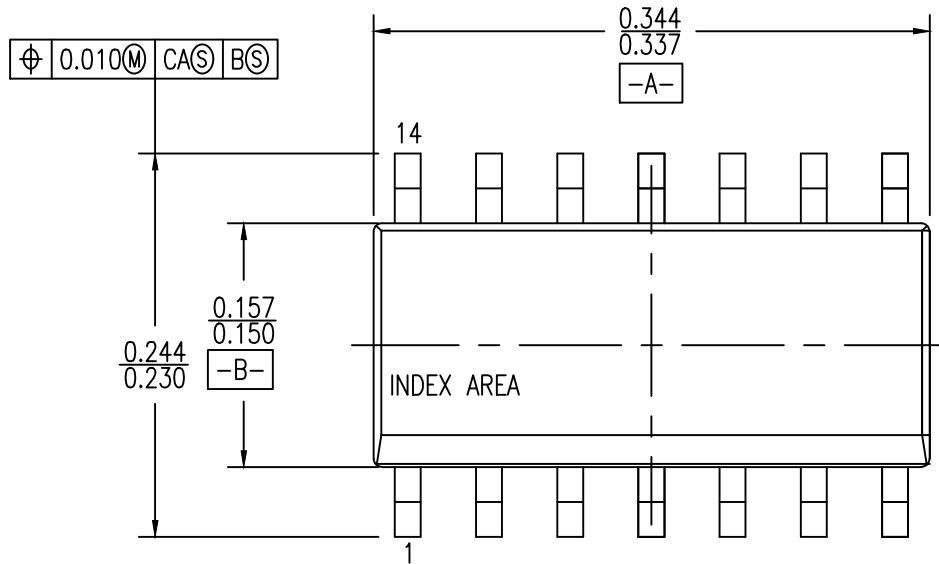

- NOTES:
1. ALL DIMENSIONING AND TOLERANCING CONFORM TO ANSI Y14.5M-1982
 2. ALL DIMENSIONS ARE IN INCHES

TOLERANCES UNLESS SPECIFIED		 6024 SILVERCREEK VALLEY RD SAN JOSE CA 95138 PHONE: (408) 284-8200 FAX: (408) 284-8591 www.IDT.com
DECIMAL	ANGULAR	
XX±	±	
XXX±		
XXXX±		
TITLE DCG14 Package Outline Drawing 0.150" Body Width 0.050" Pitch SOIC		
SIZE	DRAWING No.	REV
C	PSC-4773	00
DO NOT SCALE DRAWING		SHEET 1 OF 2

DATE		REVISIONS		
CREATED	REV	DESCRIPTION	AUTHOR	
7/28/18	00	INITIAL RELEASE, REVISE FROM PSC-4068-01	RC	

NOTE: REFER TO DCP FOR OFFICIAL RELEASE DATE

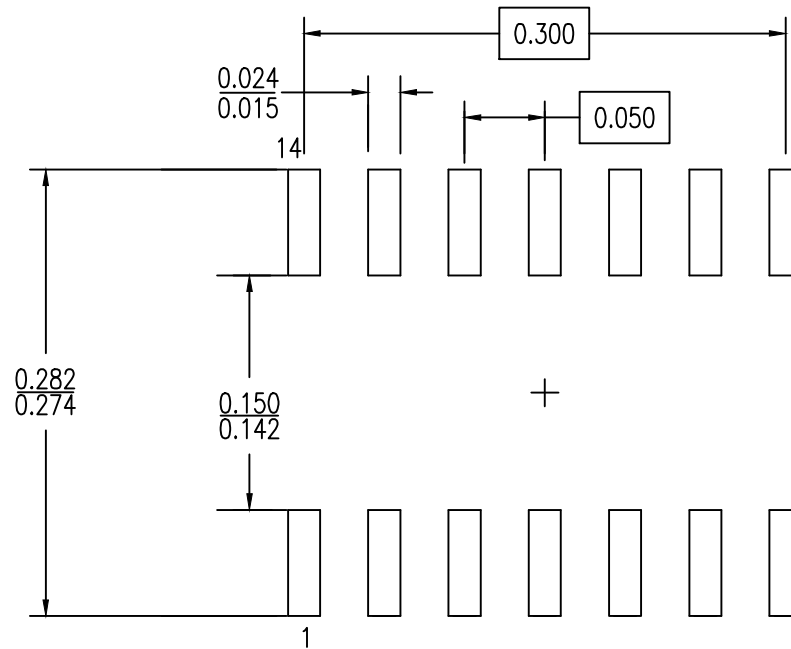

RECOMMENDED LAND PATTERN DIMENSION

NOTES:

1. ALL DIMENSIONING AND TOLERANCING CONFORM TO ANSI Y14.5M-1982
2. ALL DIMENSIONS ARE IN INCHES

TOLERANCES UNLESS SPECIFIED		6024 SILVERCREEK VALLEY RD SAN JOSE CA 95138	
DECIMAL	ANGULAR	PHONE: (408) 284-8200	
XX±	±	FAX: (408) 284-8591	
XXX±		www.IDT.com	
XXXX±		TITLE DCG14 Package Outline Drawing 0.150" Body Width 0.050" Pitch SOIC	
SIZE	DRAWING No.	REV	
C	PSC-4773	00	
DO NOT SCALE DRAWING			SHEET 2 OF 2